

- INSTRUCTION MANUAL -

ARCS WALL SCONCE

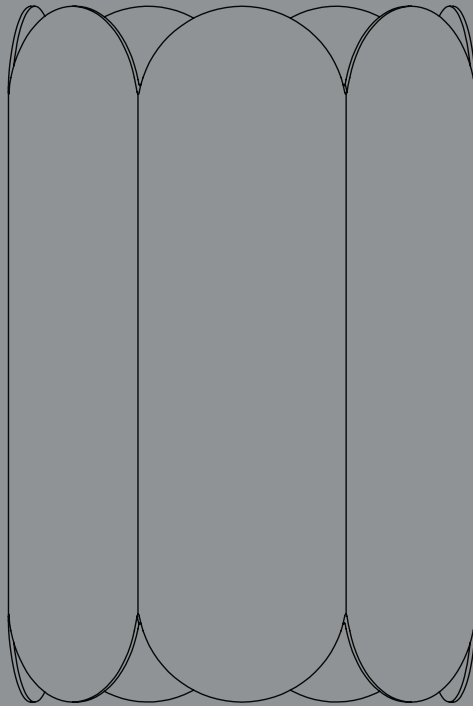

DESIGN BY MULLER VAN SEVEREN

HAY

- GENERAL INFORMATION -

TECHNICAL DATA

This product is fitted with an E14 (EU) or E12 (US) bulb fitting. HAY recommends using this product with a LED bulb.

FITTING TYPE | LED E14

POWER (W) | 5-8W

COLOUR TEMPERATURE | Warm white

HAY will not accept any responsibility for any accidents, injuries or damages that occur due to the use of incorrect bulbs.

ATTENTION

Ensure that the power supply to the circuit has clearly been turned OFF before installing the product. In some countries, electrical installation must be carried out by authorised electricians/contractors; please check with your local authority for guidance.

The product must not be modified in any way. HAY accepts no responsibility for any products that have been modified or tampered with. If the external flexible cable or cord of this luminaire is damaged, it should be exclusively replaced by a qualified electrician in order to avoid an electrical hazard. This lamp is designed for indoor use only.

CARE AND MAINTENANCE

The product can be cleaned with a soft damp cloth and mild detergent, or a dry microfibre cloth. Do not use alcohol or any other solvents to clean the product and avoid using abrasive or rough sponges. Ensure that the power supply has been turned OFF before cleaning the product.



- PARTS -

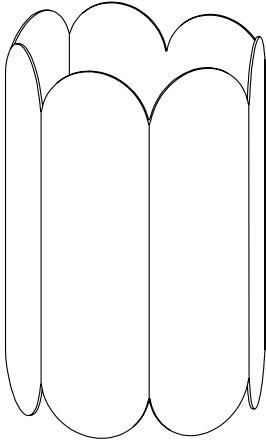

Shade

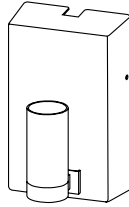

Junction box

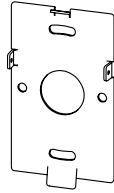

Backplate

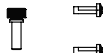

Top and side
mounting screws



Wall plugs and
screws

1.

Unpack all the parts and check that you have received all the parts listed. Before installing the lamp, make sure that the power is turned off. Mark the position of where the lamp should be placed on the wall and drill two holes using the correct type of drill for the wall you are drilling into. The holes on the backplate can be used as guides, to ensure the correct distance between the holes.

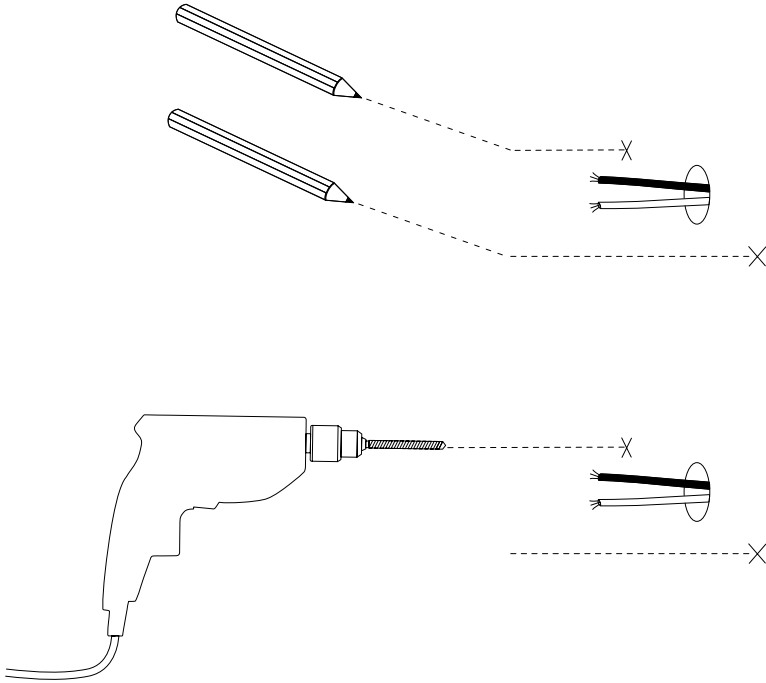

2.

Insert the wall plugs. Ensure you use the correct type of wall plug for the type of wall the lamp is to be mounted on. Once the wall plug is in place, you are ready to mount the backplate with the included screws. If the bracket is mounted directly onto a junction box, the included wall plugs and screws are not needed.

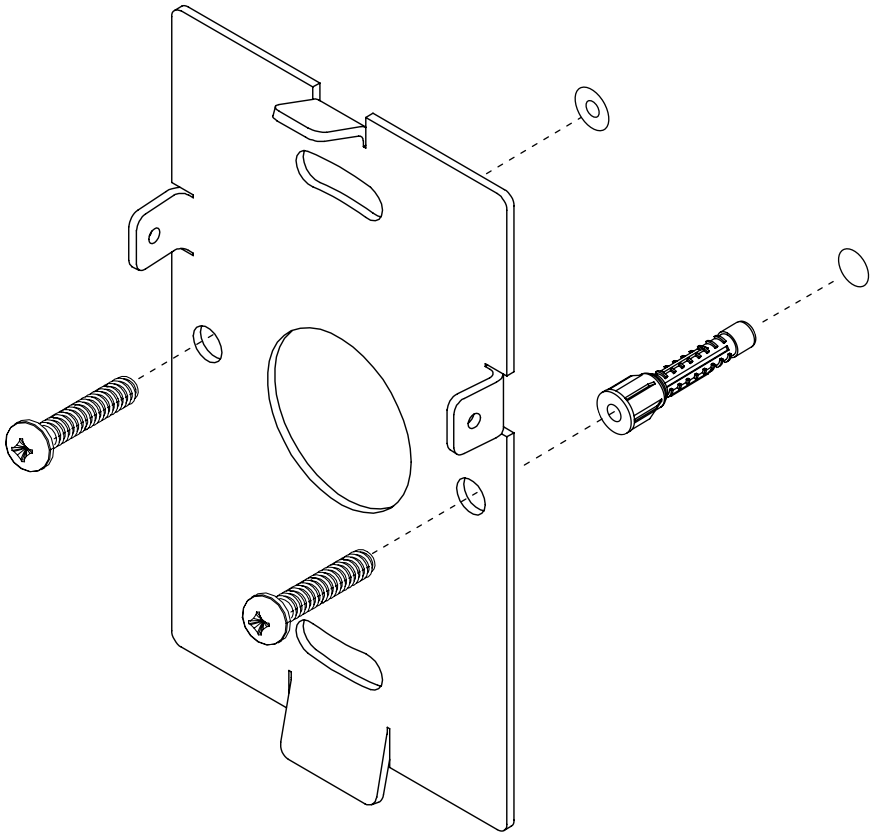

3.

Pull the power cables through the large hole in the centre of the the junction box's backplate.

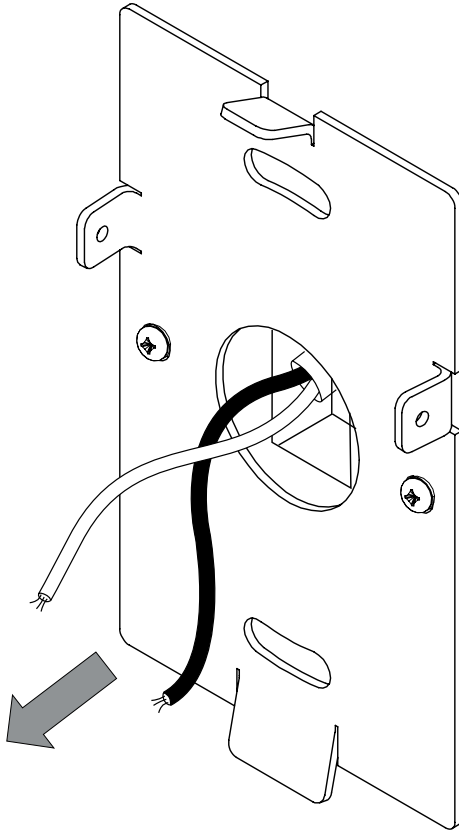

4.

Open the connector block and remove the insulating tube. Gently pull this insulating tube over the power cables that are now protruding from the hole in the centre of the backplate.

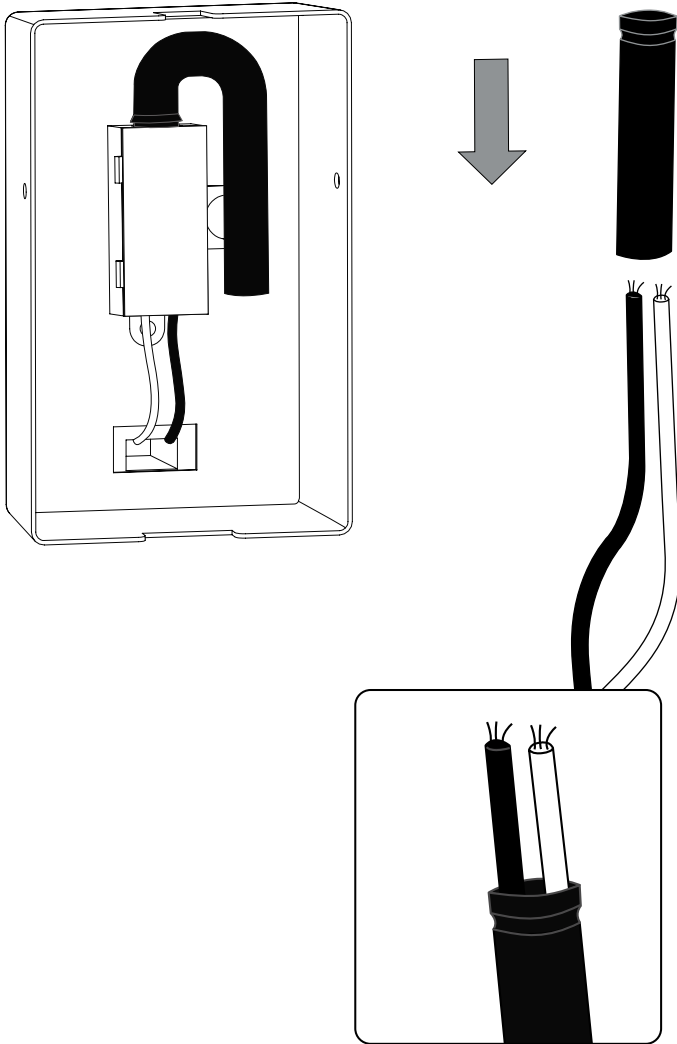

5.

Now protected by the insulating tube, you can insert the protruding power cables into the junction box terminal block. Make sure that there is approximately 5mm of exposed wire to ensure a proper connection. To connect the cables, insert the exposed wire into the corresponding slot on the side, as pictured below. If needed, insert a flat screwdriver into the slot on the top and push down while inserting the wire. Repeat with the neutral cable. Once the wires have been properly connected and secured, the connector block can be closed.

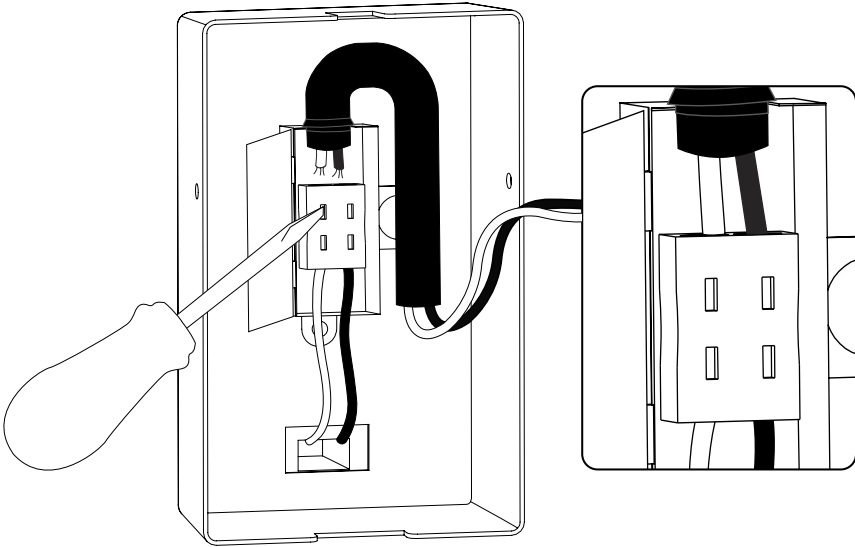

NOTICE

Live mains cable to live lamp cable.
Neutral mains cable to neutral lamp cable.

6.

Place the junction box over the backplate, before inserting and fastening the supplied mounting screws on each side of the junction box. Make sure it is fixed firmly in place. Take care not to overtighten the screws as this could damage the threads.

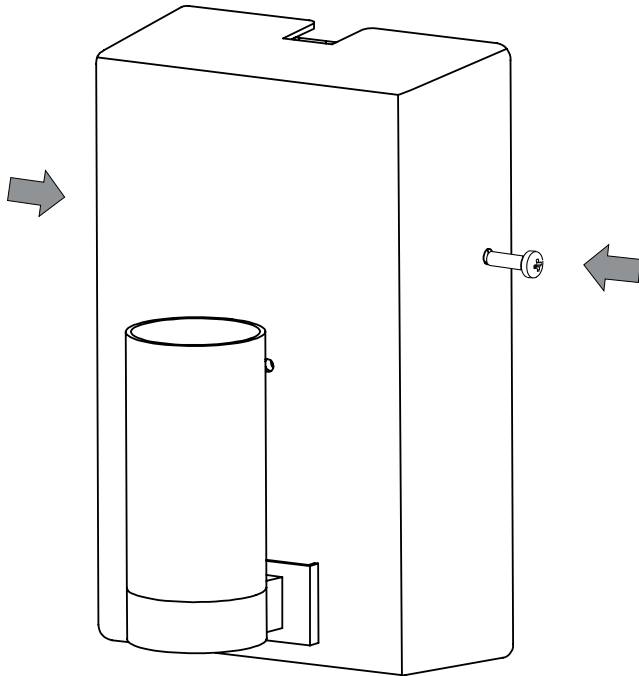

7.

Place the lamp shade carefully on the junction box. Place the shade so that it sits behind the bottom tab on the mounting bracket, and ensure it sits in place. Move the shade towards the wall and align the top screw with the top tab of the junction box.

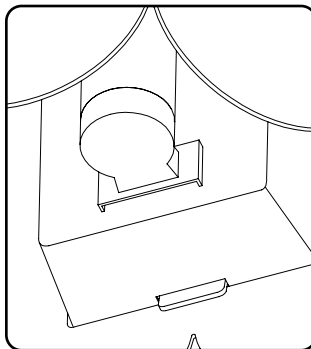
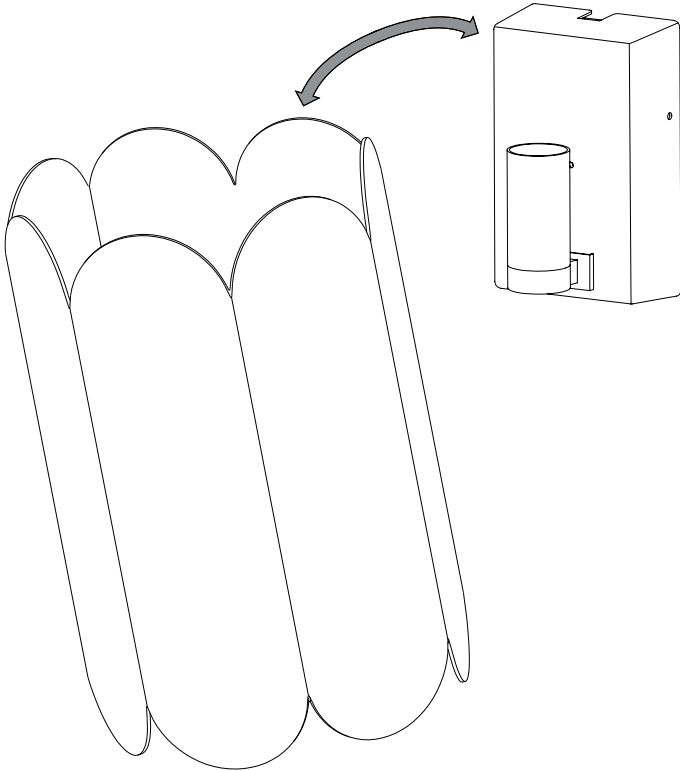

8.

Tighten the top screw carefully, until the shade sits firmly up against the wall. When the top screw is tightened, the bottom of the shade pulls upwards and locks behind the bottom tab of the mounting bracket. Once this step is done, the shade should sit firmly in place.

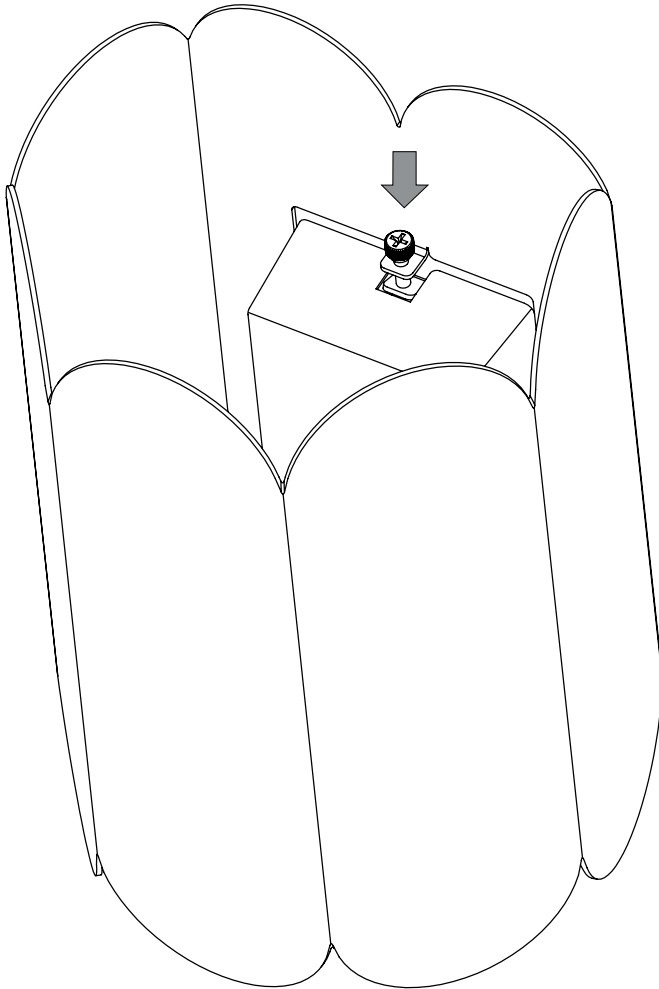

9.

Ensure that the power is off and screw an E14 bulb into the bulb fitting.

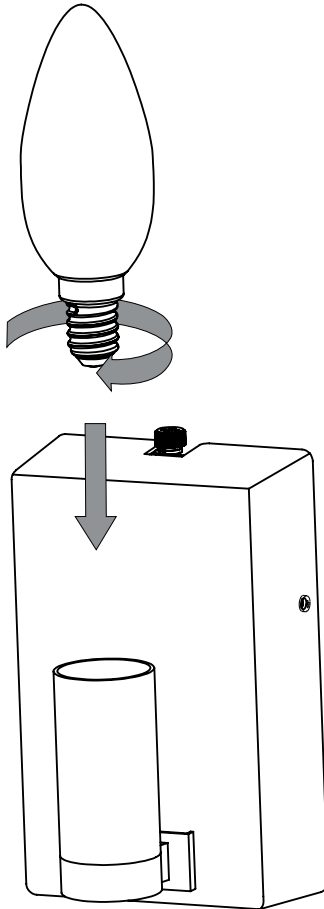

10.

Turn the power back on and test that the lamp is working.

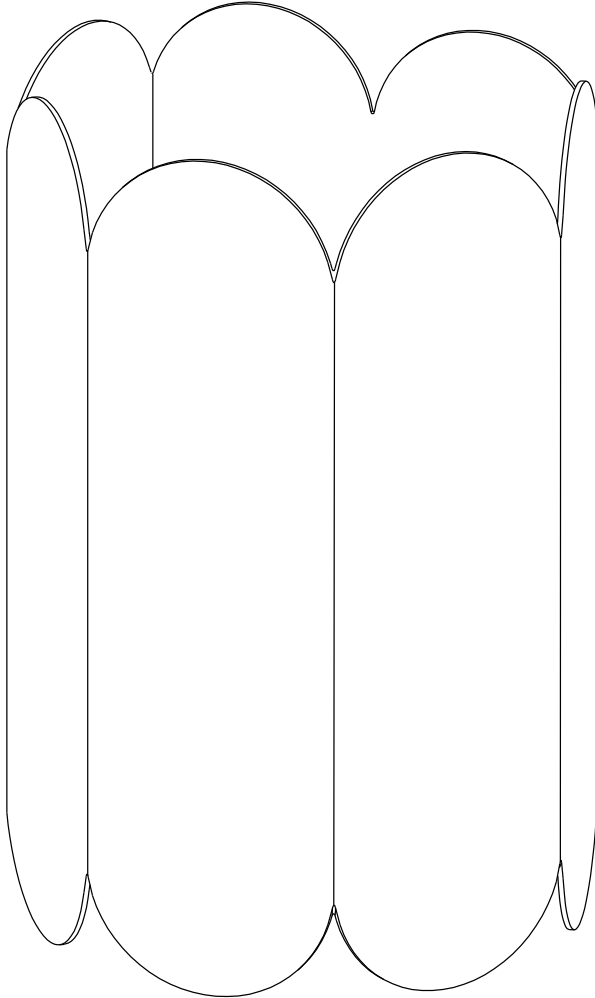

- CARE & MAINTENANCE -

Our Care & Maintenance offers guidance for optimal maintenance of your HAY product. It includes advice and instructions on cleaning and caring for specific materials to prolong the life of your lighting.



Please find our Care & Maintenance guide by scanning the QR code



You can find more relevant information on Arcs Wall Sconce by scanning the QR code

You can also find the same information here
hay.dk/downloads

Havnen 1 8700 Horsens Denmark
+45 3164 6000 / hay@hay.com

www.hay.com

10/01/2023

HAY