

MARKET SET

LA LUMIÈRE A DU STYLE

ACTUA 2022

SOMMAIRE

PRÉSENTATION ENTREPRISE	4
SCREEN 70'S	10
MOKUZAÏ	18
SINGAPOUR OUTDOOR	26
COSINESS	32
LÉGENDE	36
RÉSEAU COMMERCIAL	39

MANUFACTURE FRANCE FABRICATION FRANCE

MARKET SET est une marque du groupe COREP LIGHTING, fabricant et CRÉATEUR de Luminaires en France, depuis 1970 à Bègles en Gironde.

MARKET SET développe des gammes inspirées des dernières tendances, des nouveaux usages et des besoins de ses différents marchés.

À ce titre, son équipe de designers met au point des collections spécifiques chaque année. Afin de protéger et pérenniser ce savoir-faire, MARKET SET dépose ses catalogues et ses modèles pour mieux garantir l'originalité des produits proposés. MARKET SET se réserve ainsi le droit d'utiliser ces outils et son antériorité à des fins légales pour toujours mieux satisfaire ses clients et leur assurer la primeur et la différence de ses gammes.

MARKET SET souhaite illustrer plus que jamais son statut de créateur de Lumières.

Market Set is a brand of Corep Lighting Group, manufacturer and designer of decorative lights in France, since 1970, in Bègles in Gironde.

Market Set has been developing ranges inspired from last trends, new uses and needs for different markets. As such, its team of designers develops specific collections each year. To protect and perpetuate this know-how, Market Set registers its catalogues and its models to assure the originality of its products. Market Set reserves the right to use those means and its anteriority to legal purposes, in order to even better satisfy its customers and to guarantee them scoops and differences in its ranges.

Market Set wishes to materialize more than ever its status of designer of Lights.



4



5

SCANNEZ MOI POUR DÉCOUVRIR NOTRE SHOWROOM VIRTUEL

Scan me to discover our virtual showroom



SCREEN 70'S

La gamme SCREEN nous fait voyager dans le temps, avec une toute nouvelle forme d'écrans rétro inspirés du design graphique des années 70.

Dans un mix inédit de matières toujours plus cosy, cette nouvelle version, dessinée et façonnée dans nos ateliers en France, joue sur un équilibre parfait des couleurs et du contraste chaleureux et indémodable de sa palette de tons de terre.

La toile de jute, le lin lavé Curry et le tout nouveau lin Bouleau sélectionnés avec soin sont des tissus 100% lin Européen. Un jeu de textures toujours plus subtil, une qualité toujours plus fiable, et un engagement toujours plus responsable.

The SCREEN range takes us back in time, with a brand new form of retro screens inspired by the graphic design of the 1970s.

In an original mix of materials, this new version, designed and manufactured in our workshops in France, plays on a perfect balance of colours and the warm and timeless contrast of its earthy palette.

The hessian, the Curry washed linen and the brand new Birch linen have been carefully selected as 100% European linen fabrics. An ever more subtle play of textures, ever more reliable quality, and ever more responsible commitment.

656878



656880



656885



656879



9

656884



656883



8

NEW SCREEN 70'S

Design
MARKET SET

Suspension XL esprit mobile. Structure en métal peint, 10 écrans en lin bordés en tissu. Équipée d'une cordelière textile et d'un pavillon en métal adaptable DCL.

Mobile style pendant light big size. Painted metal frame, 10 linen screens fabric edges. Delivered with textile cord and metal canopy DCL adaptable.

80236



E27 // 60W max.

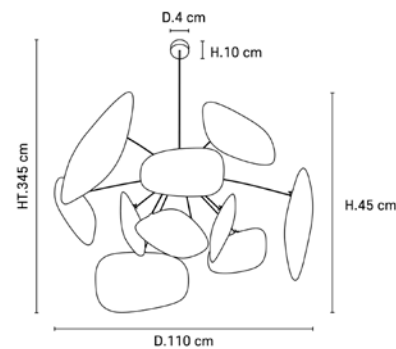

80236 - 656878

lin



Design
MARKET SET

Applique base en métal peint avec abat-jour 1 écran en lin.

Painted metal base wall light and its linen paper screen with fabric edges lampshade.

80239



E27 // 40W max.

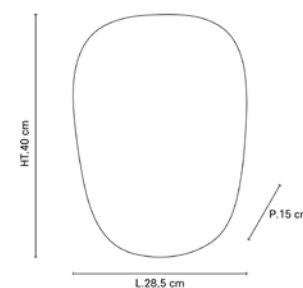

80239 - 656881

bouleau



80239 - 656883

jute



80239 - 656882

curry



10

Design
MARKET SET

Suspension XXL esprit mobile. Structure en métal peint, 13 écrans en lin bordés en tissu. Equipée de cordelières textiles et d'un pavillon en métal adaptable DCL.

Mobile style pendant light. Painted metal frame and 13 linen screens with fabric edges. Textiles cords included. Large model and metal canopy.

80238



4XE27 // 60W max.

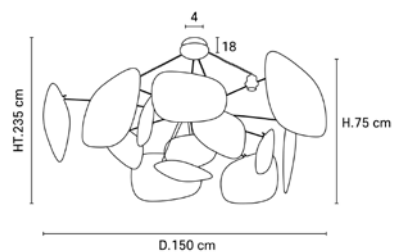

80238 - 656880

lin



Design
MARKET SET

Applique 2 lumières base en métal peint. Abat-jour composé de 2 écrans en lin.

2 lights painted metal base wall light and its 2 linen screens with fabric edges lampshades.

80237



2XE27 // 40W max.

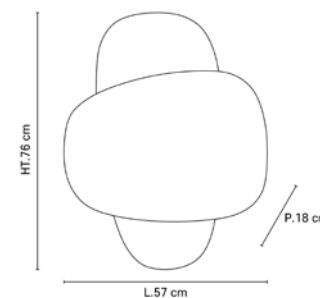

80237 - 656879

lin



11

SCREEN 70'S

Design
MARKET SET

Lampe base en métal peint. Abat-jour composé de 2 écrans en lin. Interrupteur et câble textile
Painted metal base table lamp. 2 linen screens composed lampshade. Switch and textile cord

80240



E27 // 40W max.



Ampoule conseillée
Recommended bulb

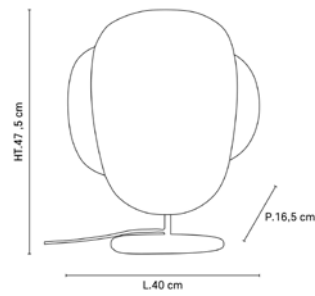

A60
654313

80240 - 656884
bouleau/curry



12

Design
MARKET SET

Lampadaire 3 lumières base en métal peint. Abat-jour composé de 5 écrans en lin. Interrupteur au pied et câble textile
3 lights painted metal base table lamp. 5 linen screens composed lampshade. Footswitch and textile cord

80241



3XE27 // 40W max.



Ampoule conseillée
Recommended bulb

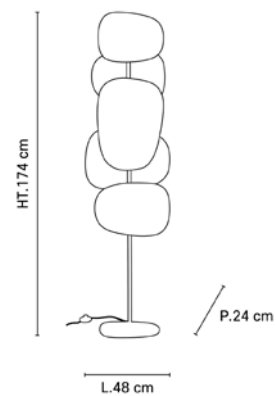

A60
654313

80241 - 656885
lin



656885

13

MOKUZAI

Résolument masculine, notre nouvelle gamme MOKUZAI est une véritable ode à la sophistication.

Les suspensions et abat-jour, fabriqués dans notre atelier en France, sont sobres d'apparence, mais surprennent par la finesse de leur jacquard intérieur, dont le motif évoque les éléments d'un paysage onirique japonais. Un diffuseur conique en papier Murano, rappelant le papier de riz, permet à la fois de créer un jeu de réflecteur dans l'abat-jour pour intensifier l'éclairage, mais aussi de diffuser une lumière douce dans la pièce. Les bases en frêne, fabriquées au Portugal, adoptent des formes douces et fuselées sublimes par des teintes de noyer, inspirées des codes vintages du design scandinave des années 60.

La Gamme MOKUZAI propose les pièces parfaites pour les adeptes de design épuré avec un style sobre et contemporain, tout en apportant une touche vintage.

Definitely male, our new MOKUZAI Collection is a veritable hymn to sophistication.

The pendant lights and shades, made in our factories in France, are visually sobers, but, surprising by the internal jacquard fabric delicacy, whose the motif evokes elements of a dreamlike japanese landscape. A Murano paper conic diffuser, evoking rice paper, could in one hand, create a reflexion game inside the shade to intensify the light, and in an other hand, diffuse a soft light in the room. The ash wood bases, made in Portugal, adopt soft and well shaped sublimated by walnut wood tints, inspired vintage cods from the 60'scandinavian design.

The MOKUZAI Collection suggests perfect pieces for sleek design followers, with a contemporary and sober style, while bringing a vintage touch.

PR503890



656056



16



PR590318

656054



PR503888



17

MOKUZAI

Design
MARKET SET

80221 // 80222

Suspension forme conique bi-matière avec cover en papier murano. Équipée d'un cordon textile et d'un pavillon en métal peint adaptable DCL.

Conical bi-material pendant light with murano paper cover and a textile cord and painted metal canopy. Adaptable DCL.

80221



E27 // 40W max.



80222

E27 // 40W max.

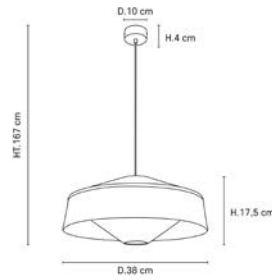

80221 - 656053

suna

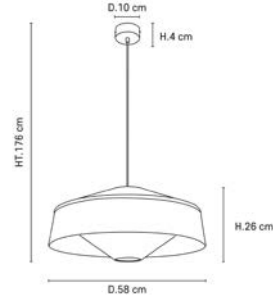

80222 - 656054

suna



Design
MARKET SET

Suspension 3 lumières forme conique bi-matière avec cover en papier murano. Équipée d'un cordon textile et d'un pavillon en métal peint adaptable DCL.

3-light conical bi-material pendant light with murano paper cover and a textile cord and painted metal canopy. Adaptable DCL.

80223



3XE27 // 15W max.

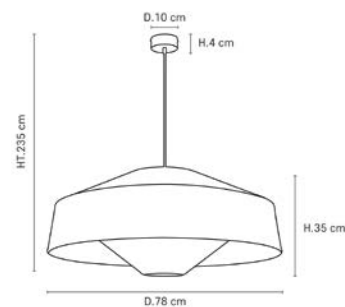

80223 - 656055

suna



Design
MARKET SET

Applique forme conique bi-matière avec cover en papier murano. Équipée d'une base ronde en métal peint adaptable DCL.

Conical bi-material wall light with murano paper cover and a painted metal round base. Adaptable DCL.

80224



E27 // 40W max.

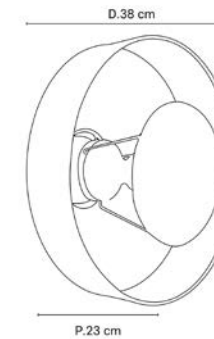

80224 - 656056

suna



MOKUZAI

Design
MARKET SET

80225 // 80226

Lampe en bois massif. Abat-jour forme cylindre en tissu dépolluant équipé d'un cover en papier murano ou abat-jour conique bi-matière. Cordon textile et interrupteur.

Massive wood table lamp. Depolluting fabric cylinder lampshade and a murano paper cover, or bi-material conical lampshade. Textile cord and switch.

80225 // 80226



E27 // 60W max.



M

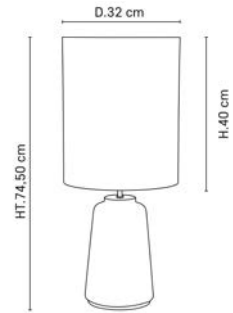

80225 - PR503499
blanc

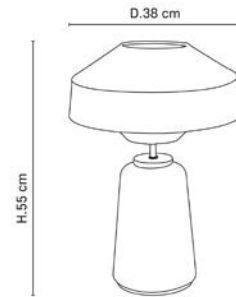

80225 - PR590318
suna

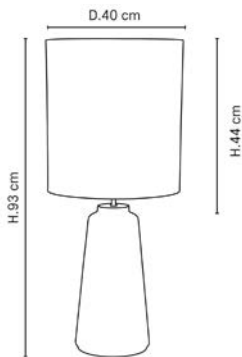

80226 - PR503500
blanc

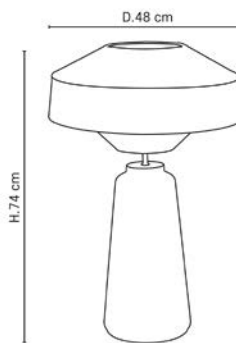

80226 - PR590319
suna



NEW

Design
MARKET SET

80244

Lampadaire en frêne massif. Abat-jour conique bi-matière. Équipé d'un cover en papier murano et d'un cordon textile avec interrupteur au pied.

Massive ash wood floor lamp with bi-material conical lampshade and a murano paper cover and textile cord with footswitch.

Lampadaire en bois massif. Abat-jour forme cylindre en tissu dépolluant. Équipé d'un cover en papier murano et d'un cordon textile avec interrupteur au pied.

Massive wood floor lamp and depolluting fabric cylinder lampshade and textile cord with footswitch.

80244



E27 // 60W max.



21



80244 - PR503888
suna

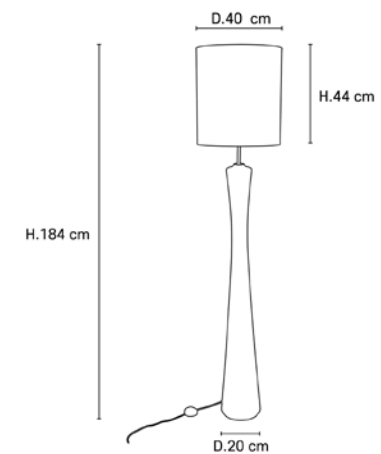
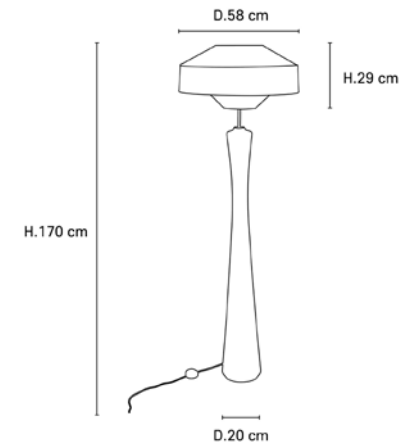

80244 - PR503890
aino blanc



20

L

SINGAPOUR OUTDOOR

MARKET SET® enrichit l'une des gammes les plus emblématiques de sa collection, la SINGAPOUR, d'une baladeuse outdoor et d'un lampadaire !

Gardant la forme iconique de lanterne asiatique, ils en reprennent tous les codes stylistiques. Du tissu coloré pour diffuser la lumière, du cannage pour évoquer l'artisanat et lui donner un look vintage, et des bordures en coton noir graphiques pour souligner ses formes.

Grâce à son abat-jour en tissu Sunbrella® déperlant, ils ne craignent pas l'humidité et résiste aux UV pour garder sa belle couleur dans le temps.

De belles soirées en perspectives...

MARKET SET® has added an outdoor portable lamp and floor lamp to one of the most emblematic ranges in its collection, the SINGAPOUR range!

Keeping the iconic Asian lantern shape, they take up all the stylistic codes of the Asian lantern. Coloured fabric to diffuse the light, cane work to evoke craftsmanship and give it a vintage look, and graphic black cotton borders to highlight its shapes.

Thanks to its lampshade in water-repellent Sunbrella® fabric, it does not fear humidity and is UV-resistant in order to keep its beautiful colour over time.

Beautiful evenings ahead...



PR503892
655891

655890
655891
655892



24

PR503892



655892



25

PR503895

SINGAPOUR

Design
MARKET SET

Baladeuse extérieur en polypropylène et poignée bambou. Abat-jour textile et cannage naturel amovible. Base LED rechargeable avec câble USB fourni. 3 températures de couleur, 2 intensités d'éclairage.

Polypropylene outdoor hand lamp with bamboo handle. Textile shade and removable natural wickerwork. Rechargeable LED base with USB cable included. 3 colour temperatures, 2 lighting intensities.

80215

LED
intégrée

4W max.

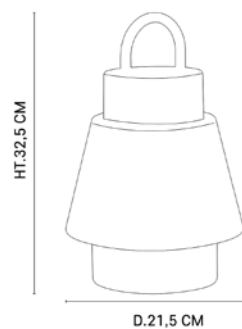
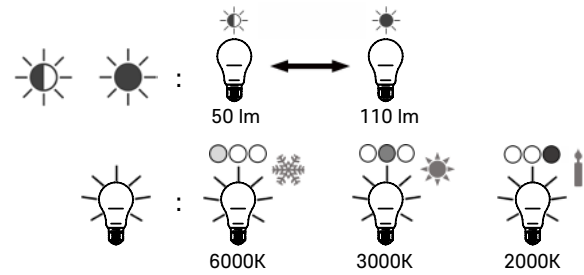
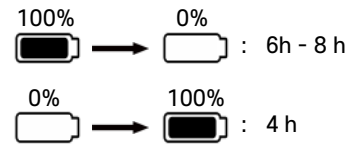

80215 - 655891
algae



80215 - 655890
honey



80215 - 655892
sand



NEW

Design
MARKET SET

80246

Lampadaire extérieur base ronde en métal peint finition sablé. Abat-jour textile et cannage naturel finition vernis marin.

Outdoor floor lamp with round base in sand finish painted metal. Textile shade and natural canework finish marine varnish.

80247

Lampadaire extérieur base ronde en métal peint finition sablé. Abat-jour textile et cannage naturel finition vernis marin.

Outdoor floor lamp with round base in sand finish painted metal. Textile shade and natural canework finish marine varnish.

80246 // 80247



E27 // 15W max.

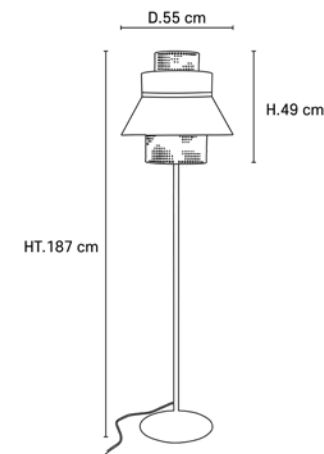

80246 - PR503892
sand/algae



80247 - PR503894
algae/sand



3 188000 780294



80246 - PR503893
sand/honey



80247 - PR503895
honey/sand



3 188000 780300

Dispo
Avril 2022
Available
April 2022

Dispo
Avril 2022
Available
April 2022



COSINESS

Retour aux seventies ! Habillée de la matière phare de la saison, la bouclette, la gamme COSINESS nous enveloppe de douceur et nous transporte dans les années 70 !

Elle nous remémore cet art de vivre et cette recherche constante du confort dans l'habitat par ses formes rebondies et sa matière bouclée que l'on a envie de caresser. Une gamme qui s'adapte à tous les intérieurs par sa sobriété et par le large choix de compositions possibles.

Back to the seventies ! Wearing the flagship material of the season, the loop stich, The COSINESS Collection wrap us softly, and throwback us to the seventies !

It reminds us this way of life and the constant habitat's comfort research by rebunded shapes and its loop stich material we would like to cuddle. A Collection which is adaptable to every interiors by its sobriety and a large choices of possible compositions.





PR503517



PR503514



PR503497



PR503887

COSINESS

Design
MARKET SET

Suspension 1 lumière avec abat-jour cylindre en tissu bouclette. Équipée d'un cordon textile et d'un pavillon en métal assorti adaptable DCL.
Matt ceramic pendant light. Loop stitch cotton lampshade. Delivered with textile cord and metal canopy adaptable DCL.

5618



E27 // 40W max.

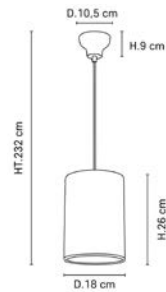

5618 - 656087
bouclette

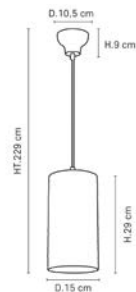

5618 - 656085
bouclette

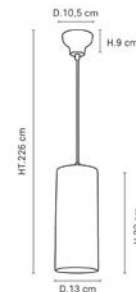

5618 - 656086
bouclette



80231

Suspension 3 lumières avec abat-jour cylindres en tissu bouclette. Équipée de cordons textiles et d'une réglette en métal assorti.

Matt ceramic pendant light. Loop stitch cotton lampshade. Delivered with textile cords and metal fixture.

Design
MARKET SET

80232

Suspension 5 lumières avec abat-jour cylindres en tissu bouclette. Équipée de cordons textiles et d'une réglette en métal assorti.

Matt ceramic pendant light. Loop stitch cotton lampshade. Delivered with textile cords and metal fixture.

80231



3XE27 // 40W max.



80232

5XE27 // 40W max.

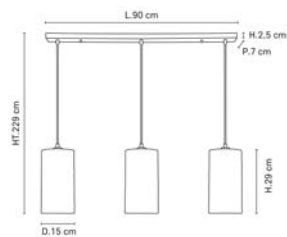

80231 - PR503513
bouclette

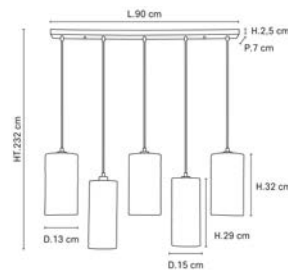

80232 - PR503514
bouclette



80233

Suspension 5 lumières avec abat-jour cylindres en tissu bouclette. Équipée de cordons textiles et d'un pavillon en métal assorti.

Matt ceramic pendant light. Loop stitch cotton lampshade. Delivered with textile cords and metal canopy.

Design
MARKET SET

80234

Suspension 8 lumières avec abat-jour cylindres en tissu bouclette. Équipée de cordons textiles et d'un pavillon en métal assorti.

Matt ceramic pendant light. Loop stitch cotton lampshade. Delivered with textile cords and metal canopy.

80233



5XE27 // 40W max.



80234

8XE27 // 40W max.

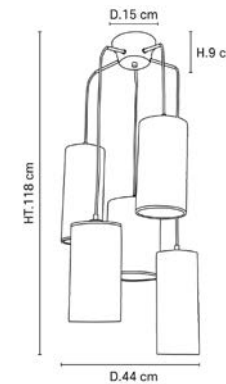

80233 - PR503515
bouclette

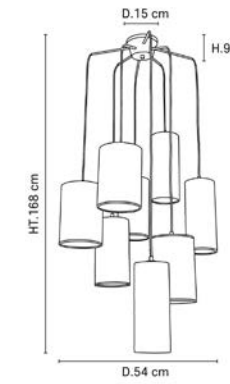

80234 - PR503516
bouclette



Design
MARKET SET

Suspension 16 lumières avec abat-jour cylindres en tissu bouclette. Équipée de cordons textiles et d'un pavillon en métal assorti.

Matt ceramic pendant light. Loop stitch cotton lampshade. Delivered with textile cords and metal canopy.

80235



16XE27 // 40W max.

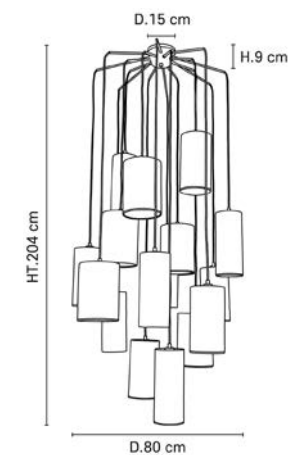

80235 - PR503517
bouclette



COSINESS

Design
MARKET SET

80227 // 80228

Lampe en céramique mat. Abat-jour conique en coton bouclette. Équipée d'un cordon textile et d'un interrupteur.
Matt ceramic table lamp with conical cotton loop stitch lampshade. Delivered with textile cord and switch.

80227 // 80228



E27 // 60W max.

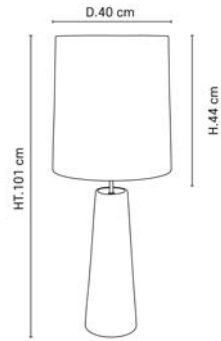
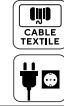

80227 - PR503497

blanc



80228 - PR503498

gris



34

NEW

Design
MARKET SET

Suspension 1 lumière avec abat-jour cylindre en tissu bouclette. Équipée d'un cordon textile et d'un pavillon en métal assorti adaptable DCL.
Matt ceramic pendant light. Loop stitch cotton lampshade. Delivered with textile cord and metal canopy adaptable DCL.

80242



E27 // 15W max.

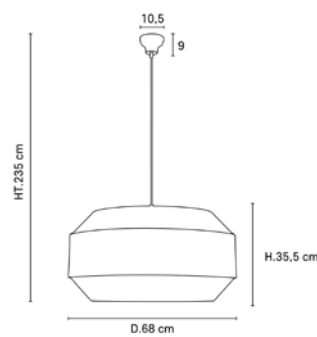

80242 - 656902

bouclette



NEW

Design
MARKET SET

Lampadaire déporté base ronde en marbre et tige en métal chromé. Abat-jour en tissu bouclette. Réglable en hauteur. Interrupteur au pied.
Offset floor lamp with round marble base and chromed metal stem. Lampshade in fabric bouclette. Adjustable height. Foot switch.

80243



E27 // 15W max.

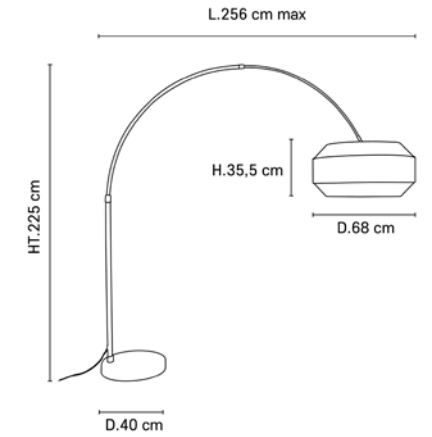

80243 - PR503887

















bouclette



35



LÉGENDE

PICTO KEY / LEGEND

PICTO	DÉSIGNATION
	Ce logo signifie que le produit a été dessiné et déposé par l'équipe Design de MARKET SET ou un designer extérieur. Ces produits sont la propriété intellectuelle de MARKET SET. <i>This logo means that the product was drawn and deposited by the design team of MARKET SET or outside designer. Products are the intellectual property of MARKET SET.</i>
	Produit fabriqué en France. <i>Product made in France.</i>
	Produit fabriqué en Europe. <i>Product made in Europe.</i>
	Abat-jour fabriqué en France. <i>Lampshade made in France.</i>
	Base fabriqué au Portugal. <i>Base made in Portugal.</i>
	Adaptable DCL : (dispositif de connexion luminaire). Le produit peut être double raccordement : boîtier de connexion standard ou DCL. <i>DCL adaptable (device light connect). The product can be double connecting : case of standard connexion or DCL.</i>
	Classe 1 : luminaire avec prise de terre. <i>fixture with ground wire.</i>
	Classe 2 : luminaire avec double isolation ou isolation renforcée. <i>reinforced or double insulation.</i>
	Classe 3 : luminaire très basse tension. <i>low voltage luminaire.</i>
1X	Nombre d'ampoule nécessaire au fonctionnement du luminaire. <i>Number of bulbs necessary for usual functionary of the luminaire.</i>
	Ampoule non incluse. <i>Bulb not included.</i>
	LED LED intégrée. <i>Integrated LED.</i>
Type d'ampoule <i>Bulb type</i>	 E14  E27  E40  G9  G4
	Interrupteur on-off. <i>Switch on-off.</i>
NEW	Nouveauté 2022. <i>2022 New product.</i>

LÉGENDE

PICTO KEY / LEGEND

PICTO	DÉSIGNATION
Boîtier Isodome	Boîtier isodome. <i>Connecting box.</i>  Interrupteur au pied. <i>Foot switch.</i>
	DEEE : Ne peut être jeté avec les autres déchets, collecte sélective en vue de sa valorisation, réutilisation ou recyclage. <i>DEEE - Can't be dropped together with the other waste, selective collection so as to be valorised, reused or recycled.</i>
CE	Sigle CE - Ce pictogramme signifie que le produit est conforme aux normes européennes en vigueur. <i>EC symbol: product compliant with European applicable standards.</i>

Température de couleur *Colour temperature*

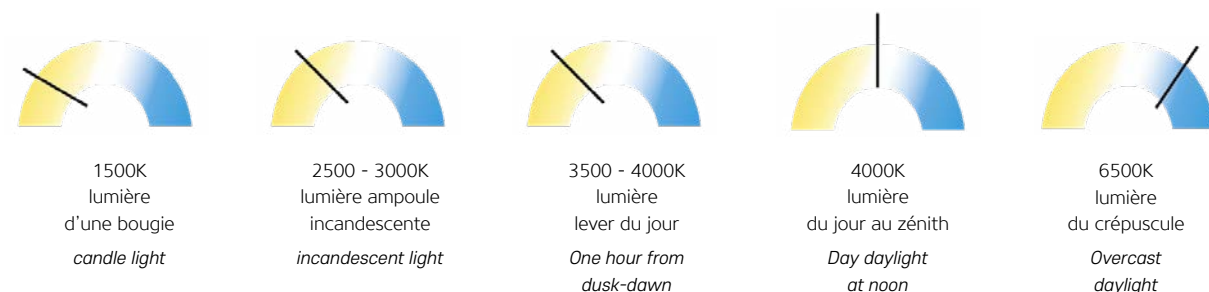

TEMPÉRATURE DE COULEUR : couleur apparente de lumière émise. Elle s'exprime en degrés Kelvin (°K). Elle permet de classer les lampes en lumière chaude <3000°K, lumière intermédiaire : 4000°K et lumière froide > 4000°K.
COLOUR TEMPERATURE: colour visible in emitted light. This is expressed in degrees Kelvin (°K). It enables lamps to be classified in terms of warm light: <3000°K, intermediate light: 4000°K and cool light: > 4000°K.

Normes *Standards*

Tous nos produits respectent la norme européenne en vigueur pour les Luminaires : NF-EN60598-1
Nos produits respectent également les normes REACH, RoHS, ERP...
Ils respectent également le règlement délégué (UE) N°874/2012 de la commission du 12 juillet 2012, complétant la directive 2010/30/UE du parlement européen et du conseil en ce qui concerne l'étiquetage énergétique des lampes électriques et des luminaires.

*All of our products adhere to the current European standard for lighting, NF-EN60598-1
They also meet the REACH, RoHS, ERP... standards.
They also comply with the delegated regulation (UE) N°874/2012 from the 12 July 2012, that complete the 2010/30/UE directive from the european parliament and from the council regarding the lightings energy labelling.*

80236	Suspension SCREEN 70'S 1L	10
80238	Suspension SCREEN 70'S 4L	10
80239	Applique SCREEN 70'S 1L	11
80237	Applique SCREEN 70'S 2L	11
80240	Lampe SCREEN 70'S 1L	12
80241	Lampadaire SCREEN 70'S 3L	12
80221	Suspension MOKUZAĬ Ø38	18
80222	Suspension MOKUZAĬ Ø58	18
80223	Suspension MOKUZAĬ Ø78	18
80224	Applique MOKUZAĬ Ø38	19
80225	Lampe MOKUZAĬ M	20
80226	Lampe MOKUZAĬ L	20
80244	Lampadaire MOKUZAĬ	21
80215	Baladeuse SINGAPOUR	26
80246	Lampadaire simple SINGAPOUR	27
80247	Lampadaire double SINGAPOUR	27
5618	Suspension COSINESS Ø18 / Ø15 / Ø13	32
80231	Suspension COSINESS 3L	32
80232	Suspension COSINESS 5L	32
80233	Suspension COSINESS 5L	33
80234	Suspension COSINESS 8L	33
80235	Suspension COSINESS 16L	33
80227	Lampe COSINESS	34
80228	Lampe COSINESS	34
80243	Lampadaire COSINESS	35
80242	Suspension COSINESS	34

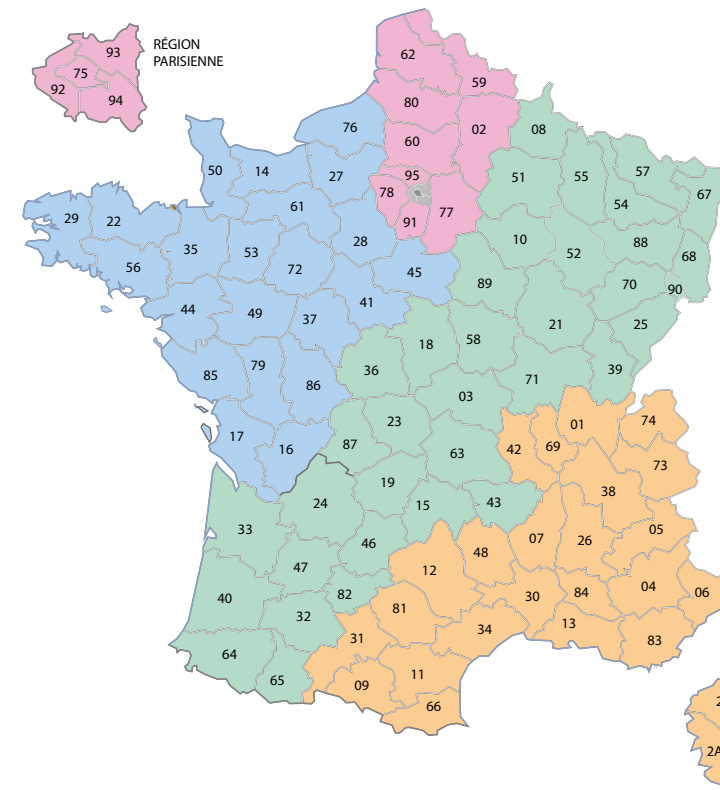

- Caroline LYMOUSI : 06 84 21 75 27
caroline.lymousi@marketset.fr
ADV : benjamin.delerue@marketset.fr
- Richard DRYK : 06 74 79 93 60
richard.dryk@marketset.fr
ADV : benjamin.delerue@marketset.fr
- Sandrine RADONDY : 06 76 96 12 82
sandrine.radondy@marketset.fr
ADV : joanna.gimenez@marketset.fr
- Pascal RADONDY : 06 76 60 11 90
pascal.radondy@marketset.fr
ADV : joanna.gimenez@marketset.fr

JULIEN LAMOURET
Directeur des ventes
Responsable DOM-TOM
05 56 49 13 66

DÉPARTEMENT FRANCE
05 56 49 80 34
contact@marketset.fr
Responsable grands comptes
joanna.gimenez@marketset.fr

DÉPARTEMENT EXPORT
+33 533 89 41 50
export@marketset.fr



ESPAGNE / PORTUGAL

José Luis ARAMBILLET
+34 606 98 26 40
joseluis.arambillet@corep.com
ADV : export@marketset.fr



POLOGNE

Dagmara MASTERNAK
+48 519 118 354
dagmara.masternak@gmail.com
dagmara.masternak@inlvio-agency.pl
ADV : export@marketset.fr



GRECE

KOUROUPIS Representations
+30 21 06 82 82 80
kouroupis_n@yahoo.com
ADV : export@marketset.fr



BELGIQUE / LUXEMBOURG

Aline RATY - Smart'in Home
+32 472 68 21 16
agency.aline@gmail.com
ADV : export@marketset.fr



PAYS-BAS

Pascal ZEGERS - Design Tales Agencies
Office +31 851 30 18 45
Mobile +31 627 65 89 45
pascal@designtales.nl
info@designtales.nl
ADV : export@marketset.fr



SCANDINAVIE

Franck PHILIPPE-MOSAIQUE
+45 21 74 33 10
franck@mosaique.dk
ADV : export@marketset.fr



ISLANDE

Maxime SAUVAGEON
+354 762 24 66
contact@aboutiquedesign.is
ADV : export@marketset.fr

NOTES

NOTES

NOTES

42

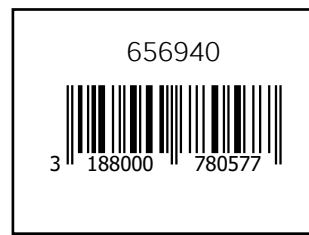

MARKET SET

LA LUMIÈRE A DU STYLE

Rue Radio-Londres
CS50001 - 33323 BÈGLES CEDEX (FRANCE)
Tél. 05 56 49 80 34
Fax 05 56 85 08 28
Mail : contact@marketset.fr

