

Collection

Timeless

Inventions

astep[®]



Good design feels eternally contemporary. As familiar as the past, as relevant as the present and as inventive as the future. Because its value taps into more than good looks.

Good design is timeless. It draws from a relentless effort to fight the status quo and go beyond what is possible. It is an endless drive to excel, create, engineer. It is courage, spiced up with a touch of stubbornness.

Good design moves along the flowless space and time of innovation. And this is exactly where Astep moves, back and forth bringing to life timeless designs and investing in contemporary inventions.

The inventions of the past that are the icons of today meeting the icons of tomorrow that are the inventions of today.





007 A Sarfatti Story
008 The Astep Identity

Evolution Collection

014 Isol
022 Pepa
028 Nox
034 Candela

Tribute Collection

040 VV Cinquanta
058 SB Cinquantotto
062 Model 2050

Gino Sarfatti Collection

068 Model 2065
076 Le Sfere Model 237 / 238
084 Le Sfere Model 2042
090 Le Sfere Model 2109
098 Model 537
104 Model 548
108 Model 566
112 Model 1063
116 Model 2129

120 Designers
124 Typology
126 Technical Info

Astep was founded in 2014 by Alessandro Sarfatti to create and curate timeless inventions with an innovative approach. Acknowledging the importance of continuously redefining, refining and remembering timeless designs, Astep retains its edge by introducing new products with advancing technologies in the **Evolution Collection**.

In the **Tribute Collection**, Astep reissues selected lighting designs as the timeless masterpieces of Gino Sarfatti in the **Gino Sarfatti Collection** and the works of established architects and designers who worked for the lighting company he founded, Arteluce.



A Sarfatti Story

The essence of evolution is to capture the best of what has been and let it evolve into the heart of what is to come. Thus, Astep continues on the path devised by two great entrepreneurs. Like all good Italian tales, mine is also a family affair and draws from father to son.

In 1939, Gino Sarfatti took the first step by founding Arteluce, a company that pioneered the use of design in the lighting business. In 1978 my father Riccardo went a step further. Together with my mother Sandra Severi and architect Paolo Rizzatto he created Luceplan, a company that tied together design and technological research. This two-folds innovative and evolutionary legacy, with the addition of a third pillar, sustainability, is the backbone of Astep.

Astep is an international company. Based in Denmark, it has its roots and its manufacturing capabilities in Italy. Merging the past and the future, it revisits the most ground-breaking designs by Italian Masters and introduces new technologies into original ideas, while investing in creating the future through partnerships with innovative designers and technologists. Because what made good design in the past is what continues to inspire us every day.

Alessandro Sarfatti
Founder of Astep

The Astep Identity

Design

For Astep design is about relationships. Behind a good project there is always a good relationship between all the people involved in the process of conception, development, manufacturing, marketing and sale. A relationship of mutual respect, fostered through the continuous exchange of ideas and visions, working towards a joint goal of developing new ideas, and relevant for people. A relationship based on trust, honesty and mutual collaboration. Ahead of a good project there is always a good relationship between objects, people and the spaces they inhabit. Because we cherish objects that adds to the quality of our experience of use, and that quality needs to be designed.

Sustainability

We are committed to circular design: we create products to last and be loved for a lifetime. But also to be repaired or refurbished if needed and, only as a last resort, be recycled. We have eliminated more than 90% of plastics in our packaging, we use recycled and recyclable plastic in our lamps. We are working on a Life Cycle Assessment study to evaluate the carbon footprint of our business and act on it accordingly. We are in the process of becoming a B-Corp, to add social and environmental good to profit. We respect people. Those who work with us and for us, and those who select our products. We follow a work ethic that prices clean manufacturing, artisanal quality and social responsibility.

Technology

There was a time in which technological innovation was a privilege of large companies. In the last 20 years, though, digitalization and miniaturization have progressively changed the rules of the game. As the Makers' culture has demonstrated, innovation is now pervasive, affordable, ubiquitous, depending on people's wits and desire to change. Astep was born to merge the agility of new technologies with good design, to turn disruptive innovation into aesthetically pleasing, and humanly relevant lighting objects.

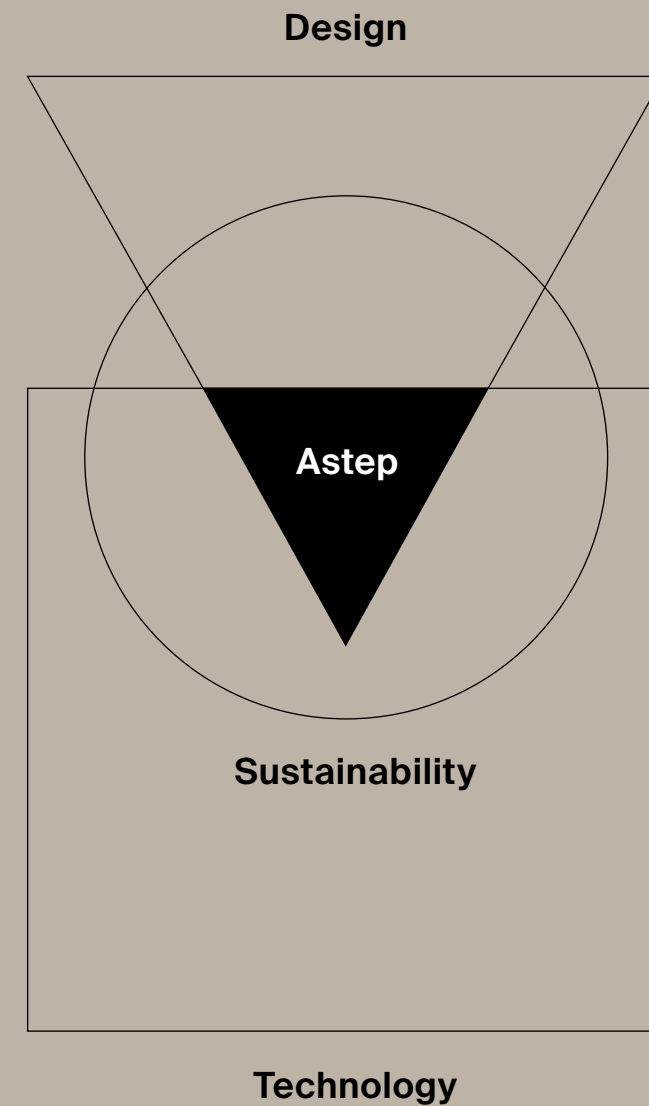



In Astep's philosophy, design and technology go hand in hand to create products that represent a real evolution in the world of lighting. The lamps of the Evolution collection are designed to bring forward solutions that were not there before: products with a prolonged life cycle, with an aesthetic and manufacturing root in Italy.

Evolution Collection

Isol
DAVID THULSTRUP
2021





Isol by David Thulstrup is a sound-absorbing light that adds architectural qualities to a space. Built on the shape of a cylinder, the lamp offers elegant functionality, pared down to its simplest expression.

Using patented sound-absorbing and extra-light material produced in Italy, Isol is the result of high-precision work. Through the application of ultrasound technology, a seamless flow of colour and texture is created, while embracing the die-cast aluminium rings. Its internal details are not directly visible from the outside, which allows the lamp to melt into the scenery. Part sculpture and part light source, Isol can be used in a variety of combinations and environments. Alone, it convinces through quiet authority. In multiples, its distinctive character is enhanced by connecting the rings to extend lighting and noise-absorbing power.

A step forward ...

In design: because it offers a sense of privacy while maintaining an elegant and high-quality design language. Placed in public environments, it has the potential to fill the room as a contemporary sculpture when multiplied.

In technology: the patented sound-absorbing fabric, stitched with ultrasonic welding technology, turns Isol into a performing and life enhancing piece of design.

In sustainability: it comes flatpacked, allowing for a more sustainable way of distribution which also involves the customer in the installation process.



ISOL

ISOL



ISOL



ISOL

Pepa

FRANCESCO FACCIN
2020





Pepa works like a pepper mill: it is lit by rotating the conical reflector connected to a multi-axis magnetic field sensor (patent pending). Turning it, up to 360°, adjusts the brightness from maximum to off, making the lamp, which is portable, perfect to create a light that is discreet or decisive whereas needed. Pepa was born from the intuition of Italian designer Francesco Faccin to create a light that needs to be touched in order to be seen. The warmth of solid ash wood and the gesture to turn Pepa on represent the happy merging of past and future, of artisan sensitivity and industrial approach.

Pepa is a perfect example of sustainable design: powered with USB-C connectivity through standard rechargeable batteries that can be purchased in any grocery store, it is built so that its life cycle is as long as possible. Its parts, assembled with only four screws are all detachable and repairable, the circuit board can be easily substituted as it is not glued. At the end of the life cycle, all parts can be dismantled and recycled.

A step forward ...

In design: for the warmth of wood and the quality of Italian manufacturing. Because it is light to touch, even before being seen.

In technology: because it turns on and off and it is regulated by simply rotating it up to 360° thanks to a multi-axis magnetic field sensor (patent pending). Because it does not have any wires, except for the charging cable with USB-C connectivity.

In sustainability: because all its parts are easy to access, repair and recycle. Pepa charges with a USB-C cable and its batteries, contrary to those of most other portable lamps that use Lithium, are standard: they can be easily purchased in any grocery store.



Nox
ALFREDO HÄBERLI
2017



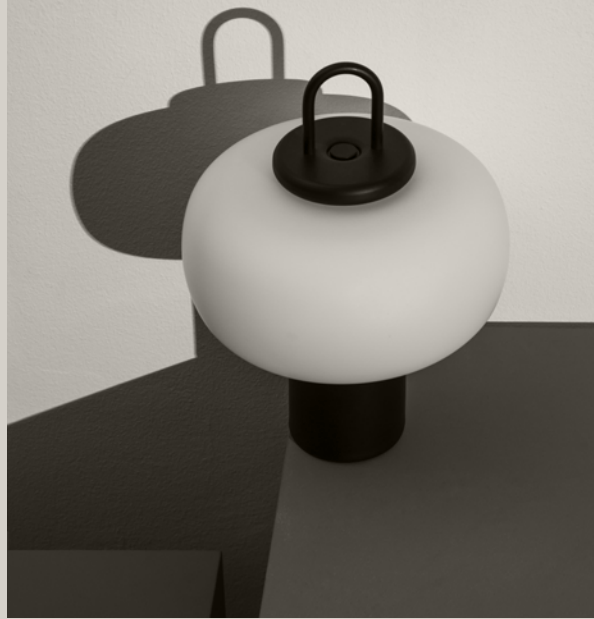

DISTINCTIVE TO NOX IS ITS WIRELESS CHARGING SYSTEM WITH INDUCTION TECHNOLOGY. NOX PROVIDES UP TO 336 HOURS OF LIGHT WHEN FULLY CHARGED



Nox, from the Latin night, is an accomplice and constant presence, thanks to its portability and flexibility as well as its wireless induction technology and its incredibly long battery life. Designed by Alfredo Häberli, made and assembled in Italy, Nox perfectly combines the artisan tradition of mouth-blown opal glass diffusers with sophisticated technology. A full recharge allows Nox to provide light for 20 consecutive hours at full light, which become 336 hours (2 entire weeks) when the intensity, adjustable with the touch dimmer, is brought to a minimum: a performance that makes it a unique case in the panorama of portable lamps. Nox is simply recharged when set on its induction base or on any other charging base with Qi technology: a way to limit the excess of ad hoc charging tools.

A step forward ...

In design: a portable lamp with a precious look and feel, unique long duration and excellent lighting output.

In technology: for the wireless induction charging system and the touch dimmer that make it portable, versatile, adaptable to other charging bases.

In sustainability: the rechargeability on any induction base, the kind we use for other devices such as smartphones, make the purchase (and therefore the making) of an ad hoc charging system redundant.

NOX



NOX

Candela

FRANCISCO GOMEZ PAZ
2016





A MODERN LANTERN
HARVESTING ENERGY FROM THE
FLAME OF BIOETHANOL



A contemporary lantern to travel through two centuries of history. Candela is the lamp with surprising and unexpected technology designed by Francisco Gomez Paz, but it is also a time machine that inverts the past with the future by combining the oldest and most modern forms of lighting in one piece. Conceived to perpetuate the tradition of Scandinavian oil lanterns, Candela (candle in Italian) is a synthesis of technology, sustainability and timeless rituals. Using the intuition of Thomas Johann Seebeck, who in 1821 discovered the way to generate electricity from the heat of a smokeless fire, the lamp works with the flame generated by the combustion of bioethanol which, in turn, ignites the LED light diffused by a lighting body in mouth-blown glass entirely made in Italy. The internal battery, charged by the flame, recharges smartphones or other electronic devices. Candela overturns the relationship between analogue and digital, because it is an object from the past that infuses energy into a technological one. The fuel tank contains the bioethanol needed for five hours of use. Candela is a visionary project that marries the genius of Gomez Paz with Astep's courage to develop the technology required to reproduce the system tested by Seebeck exactly two centuries ago.

A step forward ...

In design: It transforms a discovery 200 years ago in a contemporary object.

In technology: because it is an unexpected mix of analogue and digital. The seemingly ancient object, the candle, charges the high tech contemporary one, the phone.

In sustainability: because it is powered by biofuel and does not consume energy from fossil sources, while supplying clean energy to other tools. Rather than using energy, the lamp actually harvests it.

Projected into the future and with solid roots in the past, Astep pays homage to the tradition from which it draws inspiration to evolve. The lamps of the Tribute Collection celebrate the unrepeatable season of Italian masters who have combined design, technology and manufacturing in a unique leeway. The lamps by Gino Sarfatti, Vittoriano Viganò, Carlo Santi & Vittorio Borachia and Franco Albini & Franca Helg are a reference point for lighting design. Their sophisticated, versatile soul and timeless looks is what the Tribute Collection brings back to today's market, enriched with updated technology.

Tribute Collection



VV Cinquanta

VITTORIANO VIGANÒ

1951 / 2016

Born in 1951, the lamps of the VV Cinquanta family are among the greatest examples of timeless elegance and versatility of a product with Made in Italy design and manufacturing, a feature that they maintain unchanged in these re-editions.

Designed by the architect Vittoriano Viganò, whom Gino Sarfatti trusted for the art direction of Arteluce, they are characterized by essential and refined lines and maximum functionality. The light of VV Cinquanta can be direct or indirect. By rotating or tilting the diffuser, the lamp meets the most diverse needs, from work and reading to ambient lighting.

The Twin model is an elegant wall lamp with two brass arms: mounted on a bracket of the same material, they extend in opposite directions, defining a sculptural design with multiple luminous compositions. The Floor model stands gracefully on a slim black aluminum frame. The spun aluminum reflector is mounted on an articulated stem that can rotate and tilt, allowing for different lighting scenarios. The Wall model is mounted on a brass device that allows the reflector to rotate 350° and can be angled 160°.

In the Suspension model, the versatility of lighting becomes maximum thanks to a dynamic and playful design that invites you to act on the double stem defining infinite compositions, like real domestic architectures that stretch from the ceiling. Each of the two stems culminates with two different turned aluminum reflectors available in the colors designed by Viganò, one narrow and one wide.

They can all assume multiple and ever-changing positions, for both downward and upward lighting, direct or indirect, finding their own equilibrium.



VV Cinquanta Wall

VITTORIANO VIGANÒ
1951 / 2016





THE REFLECTOR ITSELF CAN BE ANGLED 160° AND ROTATED 350°, MAKING THE WALL MODEL AN OUTSTANDINGLY FLEXIBLE DESIGN FOR VERSATILE USE





VV Cinquanta Twin

VITTORIANO VIGANÒ
1951 / 2017



A SCULPTURAL WALL LAMP WITH MULTIPLE LIGHTING COMPOSITIONS

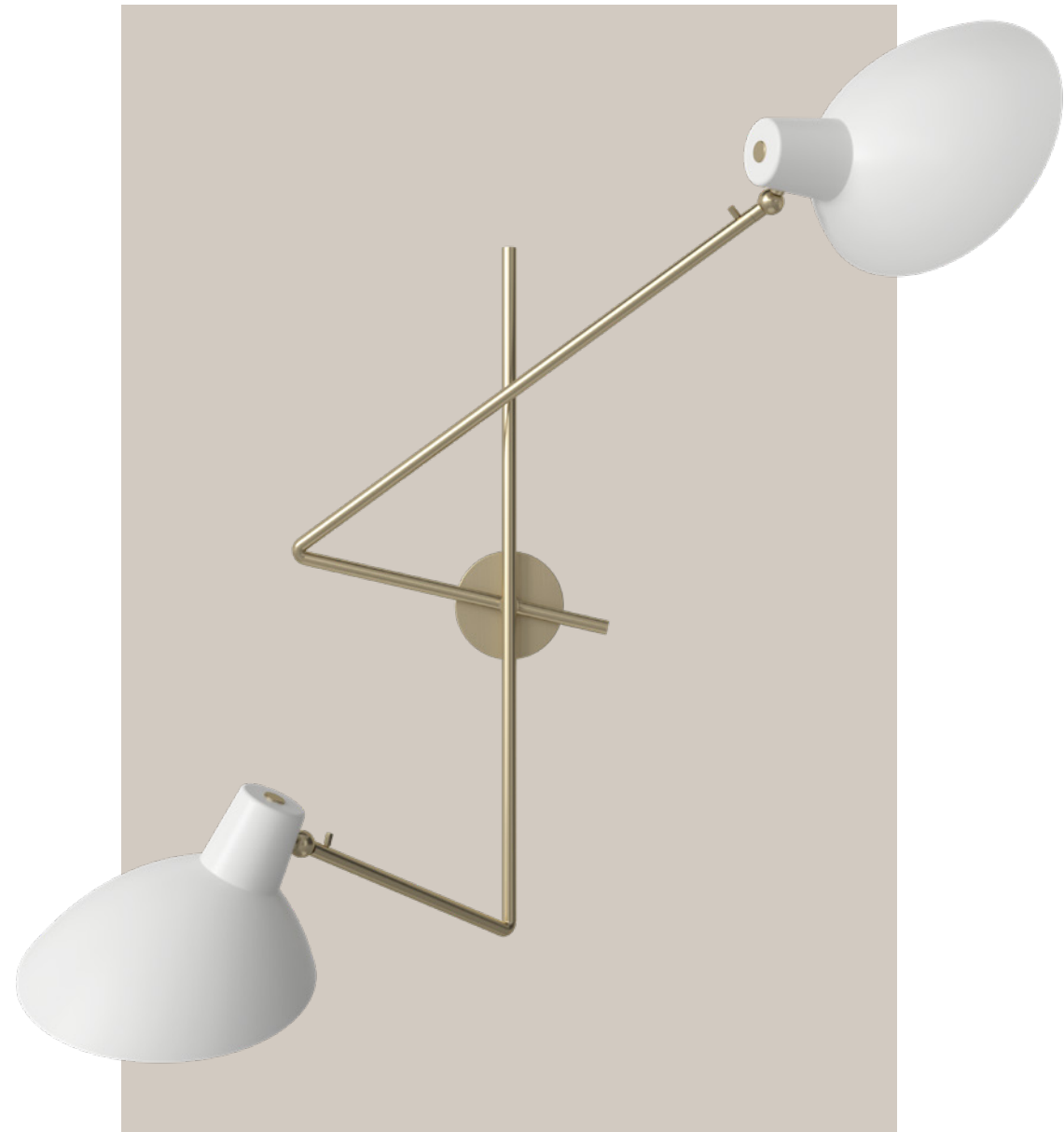

W CINQUANTA



W CINQUANTA

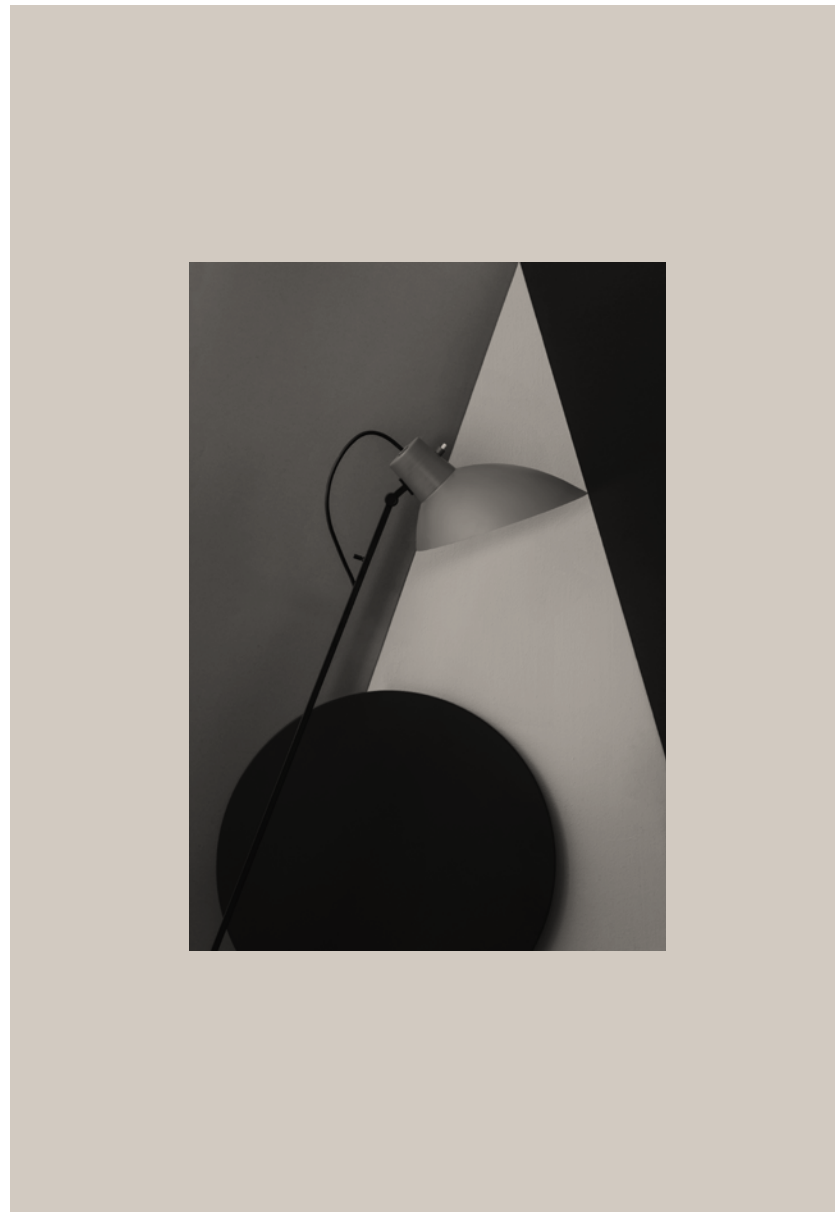

VV Cinquanta Floor

VITTORIANO VIGANÒ
1951 / 2016



THE FLOOR MODEL BALANCES GRACEFULLY
ON A SLENDER IRON BASE FOR A SOFT
AND ANGLED LIGHT





VV Cinquanta Suspension

VITTORIANO VIGANO
1951 / 2016



THE REFLECTOR IS MOUNTED ON AN ARTICULATED
STEM THAT ENABLES VARIOUS LIGHTING
SCENARIOS

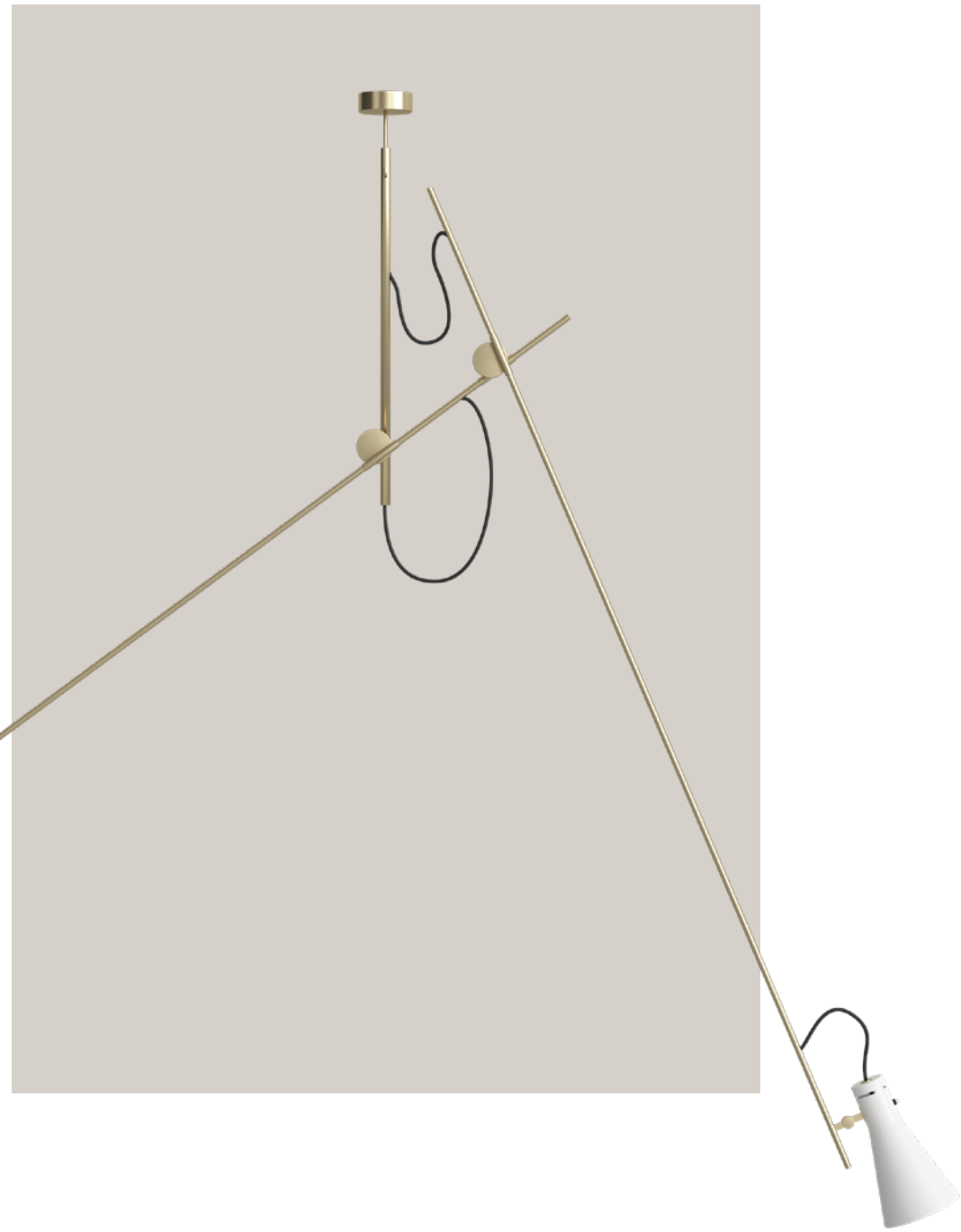

W CINQUANTA



W CINQUANTA



SB Cinquantotto

CARLO SANTI & VITTORIO BORACHIA
1958 / 2019

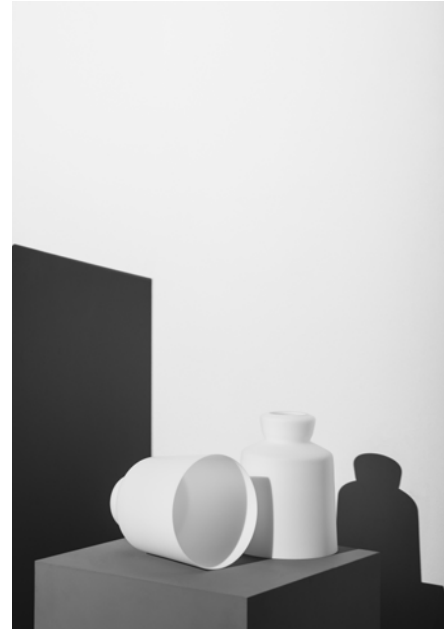

SB Cinquantotto is a design masterpiece that comes from afar and brings the emotion of a family history into the contemporary world. Designed in 1958 for Arteluce by the architects Carlo Santi and Vittorio Borachia, the prototype of this perfect example of the finest Italian manufacturing has for years embellished the Lake Como home of Gino Sarfatti, founder of Arteluce and grandfather of Alessandro, Astep's founder.

Recovered by Alessandro, who knew of its design qualities and its manufacturing of excellence since he was a child, it is re-proposed following the original design, like a suspension in satin opal glass hand blown in Italy. The timeless aesthetic of the thin diffuser, perfect for elegantly illuminating any environment, meets the mounting system based on the pattern generated by a black cable that runs freely next to an almost transparent aluminum wire.



Model 2050

FRANCO ALBINI & FRANCA HELG
1963 / 2021

MODEL 2050



MODEL 2050



In 1963, Franco Albini and Franca Helg started experimenting with plastics in lighting for Arteluce. Summoned by Gino Sarfatti to research the possibilities that new technologies and materials were providing, the two designers came up with a suspension lamp that summed up the two souls of the Arteluce brand: the love for glass, which they used for the opal diffuser, and the daring use of methacrylate, a (then new) lighter and more resistant material, perfect to interpret modernity by combining craftsmanship and industry.

With the re-edition of this iconic lamp, Astep continues its work of rediscovery of great Italian masters of light while also pursuing the same pioneering spirit in materials research that animated Albini, Helg and Sarfatti. It does so by bringing environmental sensitivity into the equation through using Green Cast, a material that is 100% recycled and recyclable, patented and made in Italy, featuring identical properties of classic methacrylate. With its brushed finish, the Green Cast used for the new 2050 diffusor restores a timeless elegance. For Astep sustainability is also about guaranteeing performance and aesthetics.





Model 2065

GINO SARFATTI
1950 / 2016

MODEL 2065



MODEL 2065



A timeless masterpiece of lightness and elegance, Model 2065 is the result of Gino Sarfatti's desire to experiment with materials. Gino Sarfatti came across methacrylate samples between 1949 and 1950. This convinced him to create a suspension lamp with this plastic polymer which is much lighter and more resistant than glass. The 2021 version adds to these features in terms of sustainability: it is made of Green Cast®, a 100% recycled and recyclable PMMA (polymethyl methacrylate) – patented and made in Italy – that has exactly the same aesthetic and functional quality of original methacrylate.

Model 2065 consists of a diffuser made up of two opalescent plates joined and suspended from the ceiling with a black painted aluminum rosette. A simple design played on the elliptical shape and the lightness of the materials which, together, seem to give life to a weightless creation. The lamp was relaunched by Astep in 2016 also in a second black version, in which the upper plate is finished with a soft-touch coating with a strong graphic expression. Five E14LED bulbs provide illumination in all versions of the lamp.

The ceiling Model 2065 was already an innovative statement in the world of lighting of the 50s. The Wall Model added to this the extraordinary capacity to re-write the formal status quo for its category: with the cables fitting inside its tube, it was stuck to the wall yet also nomadic and required no architectural or electrical intervention.





MODEL 2065



MODEL 2065



Model 2065 Wall

GINO SARFATTI
1955 / 2021





Le Sfere

Throughout his life, Gino Sarfatti has always been fascinated by the sky, especially by the perfect light emanating from the moon. Le Sfere is a testament to this special attraction of his. Conceived from 1959, it is a family of opal glass lamps, the largest designed by the master, which includes a single sphere model up to a composition of twenty-four arranged in a circular manner to form a chandelier.

Each blown opal glass sphere is held in place by a painted steel ring that embraces it and helps to define its refined aesthetics. From Model 237, consisting of a single sphere, to Model 2109, that of the iconic chandelier, Le Sfere is a family that has grown over the years also used on interior projects curated by Gino Sarfatti, for example at the Teatro di Regio di Torino designed by the architect Carlo Mollino, where they can still be admired in a variety of compositions. But, above all, it is a multifaceted and open lighting system, suitable for all types of spaces.

Model 237 / 238

GINO SARFATTI
1959 / 2018

MODEL 237 / 238



MODEL 237 / 238



MODEL 237 / 238



MODEL 237 / 238



MODEL 237 / 238



MODEL 237 / 238



Model 2042

GINO SARFATTI
1963 / 2019





MODEL 2042



MODEL 2042



MODEL 2109

Model 2109

GINO SARFATTI
1959 / 2018

MODEL 2109



MODEL 2109



MODEL 2109

Tribute / Gino Sarfatti Collection



Tribute / Gino Sarfatti Collection



MODEL 2109

MODEL 2109



MODEL 2109



MODEL 2109

Model 537

GINO SARFATTI
1950 / 2019





A LAMP THAT ANTICIPATES
AND SUGGESTS THE IDEA OF
PORTABILITY

At the origin of any model of portable lamp, there is this exceptional creation which reflects the genius and mastery of Gino Sarfatti, well ahead of his time. Model 537, designed around 1950, is a masterpiece reintroduced by Astep. In its simplicity, this lamp stands out for the combination of fine materials and its ingenious and ironic design.

The large aluminum reflector is mounted asymmetrically on a burnished or polished brass stem, which is carefully twisted, coming to rest on the marble base. The stem extends through the reflector and beyond with a backward movement, giving the upper part of the stem a dual function of playful element and practical handle that anticipates the integrated handle of contemporary portable lights by years.

Model 537 is easily carried by hand from the desk to the living room, to the bedroom to any other environment, illuminating it with genius and design.





MODEL 537



MODEL 537

Model 548

GINO SARFATTI
1951 / 2013

MODEL 548



MODEL 548



Lighting conceived as a sophisticated game of screens, in perfect balance between direct and indirect light. Gino Sarfatti designed the Model 548 in 1951 giving vent to one of the themes that were most dear and congenial to him.

For this table lamp, the designer uses a spotlight that can be oriented towards a reflective screen formed by the large diffuser in orange, blue or grey white methacrylate. The interaction between spotlight and screen defines a sophisticated effect, poised between lighting and perception. The spotlight in white painted aluminum is mounted on a tubular stem in polished or burnished brass, while a small brass bar at the base acts as a counterweight in the beautiful balancing of the individual elements.

In the re-edition, the original incandescent bulb was replaced by an LED source and an optical dimmer switch was discretely integrated into the original design.

Model 566

GINO SARFATTI
1956 / 2020

MODEL 566



MODEL 566

A simple and iconic task lamp. Designed in 1956, Model 566 by Gino Sarfatti is a masterpiece of minimalism and refinement, a tribute to the simplicity of the light bulb. The classic Cornalux bulb (no longer in production) has been replaced for this re-edition with a special and modern low energy consumption and long lasting LED technology. Playing on the geometry designed by the inclined stem and the tube that mounts the bulb, the Model 566 generates a perfect light for work, studying or relaxing reading. The tube is supported by a rubber ring that allows it to be oriented in infinite positions. The switch positioned on the base, faithful to the original model, is a further note from the past that returns in a contemporary key.



Model 1063

GINO SARFATTI
1954 / 2013

MODEL 1063



MODEL 1063



MODEL 1063

A perfect example of an avant-garde approach with a still very current design, the 1063 floor lamp designed by Gino Sarfatti in 1954 is the masterpiece that first revealed how to generate aesthetics by simply showing a light source. With its minimalist silhouette and a design that illustrates how it works, Model 1063 anticipated insights that came in the years to come. The floor lamp emits direct or reflected light and is composed of a thin black or white painted aluminum tube, which houses the light source. The aluminum base is balanced by a box, also made of aluminum, a rounded rectangular section that contains the power supply. The two parts are connected by two steel rods arranged in an unusual off-center position that seems to move them away from each other and at the same time give the luminaire a sense of balance in an apparently magical way. In the re-edition, the original fluorescent tube was replaced with an LED module with variable temperature regulation and light dimming function.

MODEL 1063

Model 2129

GINO SARFATTI
1954 / 2013

MODEL 2129



MODEL 2129



Lightness becomes an icon in the shapes of a lamp sculpted like a work of art. The droplight design of the Model 2129 designed by Gino Sarfatti in 1969 is a beautiful example of the visionary nature of the founder of Arteluce. This lamp is a versatile and functional creation, with an elegant and assertive presence, giving strength to the elements on which its light rests, defining a warm atmosphere.

Model 2129 is formed by a large arched arm in transparent methacrylate fixed to the ceiling and able to rotate 360° horizontally, and by a counterweight. The cup reflector consists of two pieces of turned aluminum painted in white and caviar gray. Both the plug for the ceiling attachment and the counterweight are in painted brass. In the re-edition, the original light source, an incandescent bulb, is replaced with LED lighting.

Designers



Gino Sarfatti

DESIGNER
(1912-1985)

Born in Venice in 1912, Gino Sarfatti studied to become an aeronautical engineer until family circumstances compelled him to relocate to Milan where he had his first encounter with lighting, an engineering project to transform a glass vase into a lamp. This encounter with lighting design and engineering shaped the path of his life. In 1939 Gino Sarfatti founded his company Arteluce, which brought lighting into the 20th century combining innovative ideas with groundbreaking design.

Throughout his career, Gino Sarfatti explored and was inspired by new product typologies, innovative materials, lighting technologies, and production techniques. His hybrid talent as a designer and engineer enabled him to create refined products in both aesthetics and function. Gino Sarfatti was a significant figure in the history of Italian industrial design, developing more than 700 luminaires. In 1973 he retired on Lake Como, with Flos acquiring Arteluce and their expansive catalog. Gino Sarfatti passed away at Gravedona in 1985.

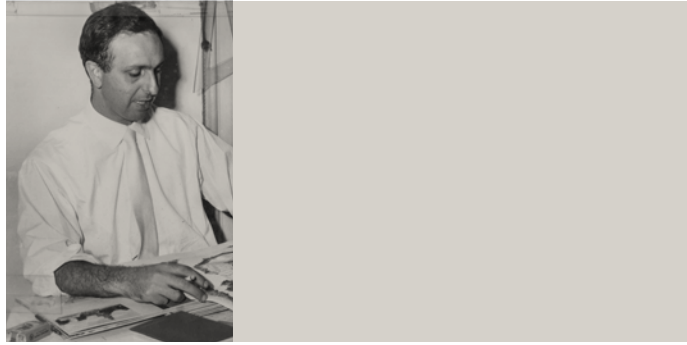

Vittoriano Viganò

ARCHITECT AND DESIGNER (1919-1996)

Son of the painter and engraver Vico Viganò, he graduated in Architecture at the Polytechnic School of Milan in 1944.

A main figure of the architectural debate in the post war period and an original interpreter of European Rationalism, he was unanimously considered by critics the most important Italian exponent of the 'Brutalism' current.

A multidisciplinary talent, a tenured professor in Interior Architecture and Urban Planning during all his life for the Milan Faculty, Vittoriano worked at various scales: from industrial design to architecture, from interior design to urban and landscape planning.

Vittoriano Viganò was Art Director of Arteluca, the company founded by Gino Sarfatti, for some years and for Arteluca he designed numerous luminaires as well as the flagship store in Via della Spiga in Milan.

In 1991 the San Luca Academy awarded him the Italian Republic President Prize for Architecture. Vittoriano Viganò passed away in Milan in 1996.



Carlo Santi and Vittorio Borachia

ARCHITECTS AND DESIGNERS (1925-2004 / 1920-2015)

Carlo Santi (1925-2004) and Vittorio Borachia (1920-2015), who make up the architectural duo Santi Borachia, met while they were both students at the Polytechnic School in Milan during the 1940s and found common ground for exploring the world of architecture and design.

Among other collaborations, the duo was involved in the lighting company Arteluca, which at the time attracted the most talented architects and designers due to the visionary and experimental approach of its founder, Gino Sarfatti.

Later, Carlo Santi's and Vittorio Borachia's spheres of interest moved on to urban planning, but from time to time they continued the exploration of lighting and furniture design, both as a duo and under their own names. Carlo Santi and Vittorio Borachia were guided by the logical and formal principles of the most recent industrial techniques and materials and aimed for an essential elegance in their design, whether in plastic, wood or glass.



Franco Albini & Franca Helg

ARCHITECTS (1905-1977 / 1920-1989)

Franco Albini (1905-1977) was a great Italian architect, a leading figure of Rationalism, one of the undisputed fathers of industrial design. His projects, the result of the partnership with Franca Helg (1920-1989), range from large to small scale, from the arrangement of the stations of the Milan Metro line 1 together with graphic designer Bob Noorda to the realization of urban, building and museum interventions all Italy. In design, Albini and Helg have linked their name to timeless furnishings and accessories, innovative in their design approach and in the choice of materials. Their production represents an internationally recognized cornerstone of the innovation of design culture at the beginning of the twentieth century.



Alfredo Häberli

DESIGNER (1964)

For many years, Zurich has been home to Alfredo Häberli and his playful design developments. Before resettling in Switzerland with his family in 1977, Alfredo grew up in Argentina, and his work is strongly influenced by his childhood experiences and native country.

He works with great emotion, energy and curiosity and benefits from having a visionary mindset, a serious attitude and a keen sense of details. The result is a collected work imbued with a strong expression and inherent emotionality and beauty.

Alfredo Häberli graduated, with distinction, as an industrial designer in 1991 and effortlessly combines tradition and innovation in every aspect of his work. He has been granted numerous awards and honours, including 'Guest of Honour' at the 20th Biennale of Design in Kortrijk (2006) and the 'Swiss Grand Prix of Design' (2014) by the Swiss Federal Office of Culture.



Francesco Faccin

DESIGNER (1977)

Constantly shifting the area of application between industrial production, independent production, community design and gallery work, Francesco Faccin, believes in design without boundaries or limits: "I am interested in design that sparks connections, thought and debate, above all those that are a product of in-depth studies beyond the object itself. Design is a fantastic opportunity to deepen our relationship with the world around us."

Born in Milan in 1977. In 2004, after a collaboration lasting almost 2 years with Enzo Mari, he began to work with the lute-maker Francesco Riolta. In 2007 started his own studio in Milan. From 2009 to 2015 he was consultant for Michele De Lucchi.

Studio Francesco Faccin collaborates on a regular basis with Italian and international clients such as design galleries (Rossana Orlandi, Nilufar), private companies, public institutions, and NGOs.

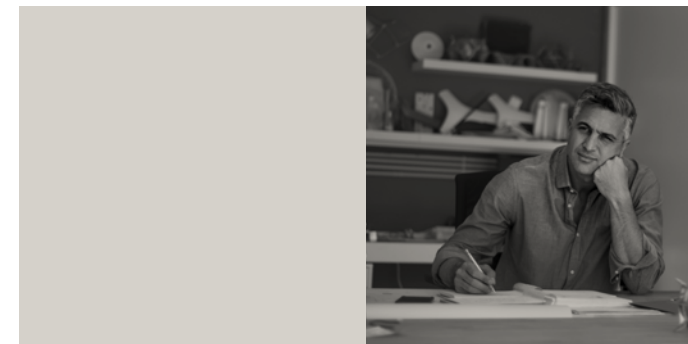

Francisco Gomez Paz

DESIGNER (1975)

Born in Salta in Argentina in 1975, Francisco Gomez Paz moved to Milan after completing studies in Industrial Design at the Universidad Nacional de Cordoba. In 2004 he opened his design studio in Milan.

Driven by a curiosity and knowledge of technology and materials, and complimented by his highly experimental hands-on creative process, Francisco Gomez Paz has developed products for a wide range of leading design companies.

His work has received several international recognitions including the Good Design Award and the Red Dot Award, both in 2010. Together with Alberto Meda, Francisco Gomez Paz was awarded the First Prize of the Index Award for the Solar Bottle, which has also been selected for the Study Collection at MOMA. In 2011 he won the Prize of Prizes to Innovation in Design for the Hope chandelier, followed by the prestigious Compasso d'Oro 2011. Works and lives between Milan and Salta.

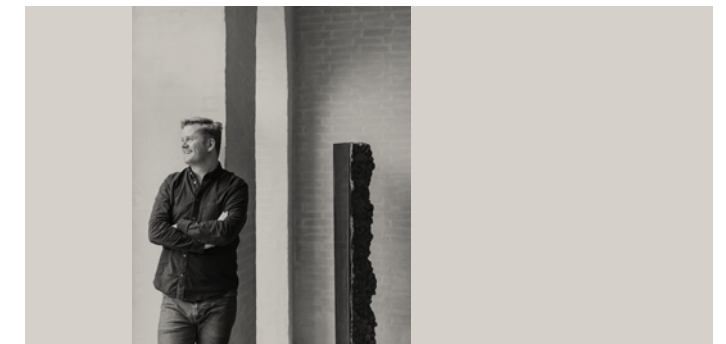

David Thulstrup

ARCHITECT AND DESIGNER (1978)

David Thulstrup brings his extensive experience as an architect and interior designer to furniture and lighting design. Using architecture and context as a starting point he creates simple well-crafted pieces that are distinctive in their form but work harmoniously in the overall space. Honest use of materials and clarity of purpose are paramount. Applying a holistic approach to his practice, David often creates furniture and lighting for specific projects but always with the intention that they can belong anywhere. Although contemporary in their expression they are designs that will stand the test of time.

Typology

Portable



Table



Floor

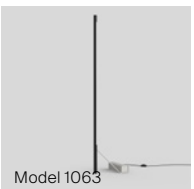

Suspension

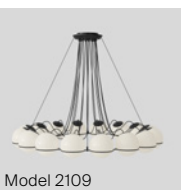
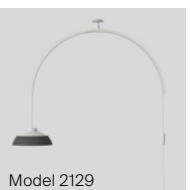
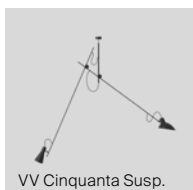

Ceiling



Wall

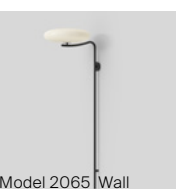
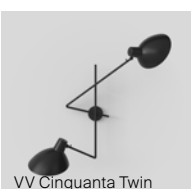

Isol 30

David Thulstrup, 2021

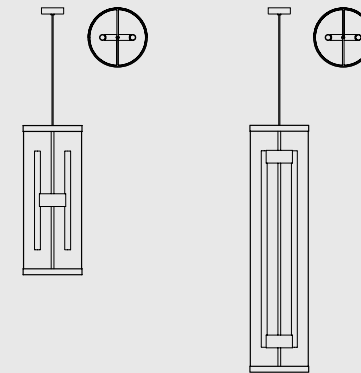

Typology	Suspension
Materials	Acoustic Absorbent Fabric Diffuser, Aluminium Structure
Dimensions	ø 300 x 760mm / ø 300mm x 1260mm
Diffuser Diameter	ø 300mm
Cable Length	3000mm
Light source	2 x S14d (6W Max) / 2 x S14s (13W Max)



Item Code	Description	Weight
A04-S51-S00B	30/76 Black	2.00kg
A04-S51-S00C	30/76 Cream	2.00kg
A04-S61-S00B	30/126 Black	2.50kg
A04-S61-C00C	30/126 Cream	2.50kg

Technical Info

Isol 45

David Thulstrup, 2021

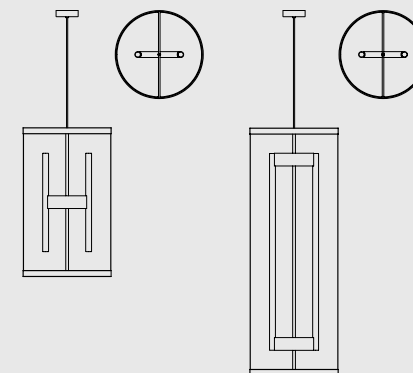

Typology	Suspension
Materials	Acoustic Absorbent Fabric Diffuser, Aluminium Structure
Dimensions	ø 450 x 760mm / ø 450mm x 1260mm
Diffuser Diameter	ø 450mm
Cable Length	3000mm
Light source	2 x S14d (6W Max) / 2 x S14s (13W Max)



Item Code	Description	Weight
A04-S51-M00B	45/76 Black	2.80kg
A04-S51-M00C	45/76 Cream	2.80kg
A04-S61-M00B	45/126 Black	3.30kg
A04-S61-M00C	45/126 Cream	3.30kg

Pepa

Francesco Faccin, 2020

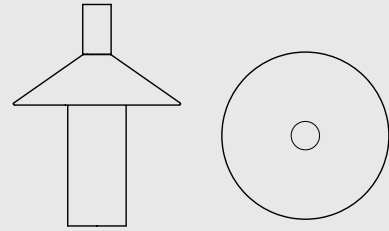

Typology	Table
Materials	Solid Ash Wood, Stainless Steel
Dimensions	ø 206 x 273mm
Cable length	1500mm
Weight	1.40kg
Control	Rotary Dimmer
Light source	Integrated LED 5W, 400lm, 2200K
Charging System	USB Cable
Connector	USB Type C
Duration	7hrs



Item Code	Description
A03-T12-00T0	Natural Ash Wood

Nox

Alfredo Häberli, 2017

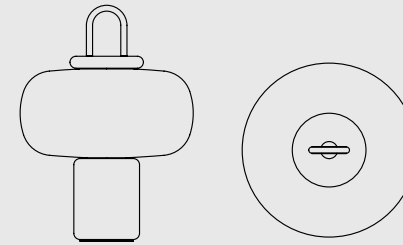

Typology	Table
Materials	Opaline Glass Diffuser, Aluminium Body
Dimensions	ø 224 x 305mm
Diffuser diameter	ø 224mm
Weight	2.50kg
Control	Touch dimmer
Light source	Integrated LED 5W, 400lm, 2200K
Charging system	Wireless Induction Requires Charging Base
Duration	20hrs



Item Code	Description	Battery Capacity
A02-T12-000B	Black	16000mAh
A02-T12-000G	Silver	16000mAh

Nox Charging Base

Optional accessory

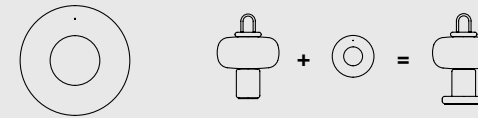

Item Code	Description
A02-A01-000B	Black
A02-A01-000G	Silver

Candela

Francisco Gomez Paz, 2016

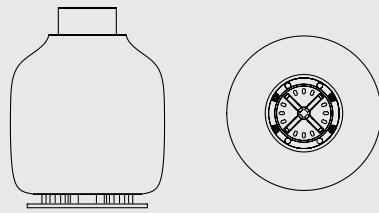

Typology	Table
Materials	Opaline Glass Diffuser, Aluminium Body
Dimensions	ø 186 x 241mm
Diffuser diameter	ø 186mm
Weight	2.70kg
Light source	Integrated LED 1.5W, 2200K
Charging system	Bioethanol Fuel
Fuel Capacity	260 ml
Duration	5hrs



Item Code	Description	Battery Capacity
A01-T10-200W	Light & USB Charge	3400mAh

VV Cinquanta / Wall

Vittoriano Viganò, 1951/2016

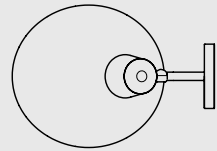
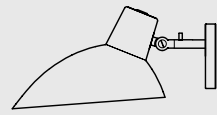

Typology	Wall
Materials	Spun Aluminium Reflector, Brass Mount
Dimensions	W256 x D364 x H183mm
Reflector diameter	ø 274mm
Weight	0.70kg
Control	Available with On/Off Switch
Light source	1 x E27 LED 7W (53W Max), 806lm, 2700K Dimmable Bulb Included



Item Code	Description	Control
T02-W21-00BB	Black Mount, Black Reflector	None
T02-W21-00BW	Black Mount, White Reflector	None
T02-W21-00BR	Black Mount, Red Reflector	None
T02-W21-00BY	Black Mount, Yellow Reflector	None
T02-W21-0018	Brass Mount, Black Reflector	None
T02-W21-001W	Brass Mount, White Reflector	None
T02-W21-S0BB	Black Mount, Black Reflector	On/Off Switch
T02-W21-S018	Brass Mount, Black Reflector	On/Off Switch
T02-W21-S01W	Brass Mount, White Reflector	On/Off Switch

VV Cinquanta / Floor

Vittoriano Viganò, 1951/2016

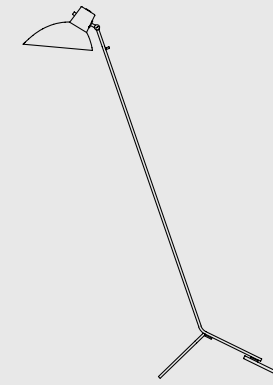

Typology	Floor
Materials	Spun Aluminium Reflector, Steel or Brass Frame
Dimensions	W487 x D1035 x H1470mm
Reflector diameter	ø 274mm
Cable Length	2000mm
Control	On/Off Switch
Light source	1 x E27 LED 7W (53W Max), 806lm, 2700K Dimmable Bulb Included



Item Code	Description	Weight
T02-F21-00BB	Black Frame, Black Reflector	2.30kg
T02-F21-00BW	Black Frame, White Reflector	2.30kg
T02-F21-00BR	Black Frame, Red Reflector	2.30kg
T02-F21-00BY	Black Frame, Yellow Reflector	2.30kg
T02-F21-01BY	Mondrian Frame, Yellow Reflector	2.30kg
T02-F21-001B	Brass Frame, Black Reflector	1.80kg
T02-F21-001W	Brass Frame, White Reflector	1.80kg

VV Cinquanta / Twin

Vittoriano Viganò, 1951/2016

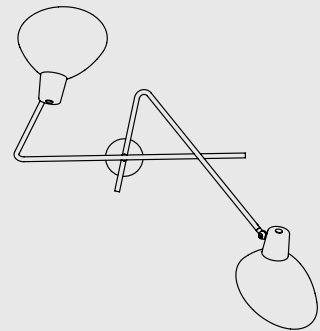

Typology	Wall
Materials	Spun Aluminium Reflectors, Brass Structure
Dimensions	W1130 x D538 x H524mm
Reflector diameter	ø 274mm
Weight	5.80kg
Light source	2 x E27 LED 7W (53W Max, 806lm (1612lm Total), 2700K Dimmable Bulbs Included



Item Code	Description
T02-W21-1BBB	Black Mount, Black Reflectors
T02-W21-11BB	Brass Mount, Black Reflectors
T02-W21-11WW	Brass Mount, White Reflectors

VV Cinquanta / Suspension

Vittoriano Viganò, 1951/2016

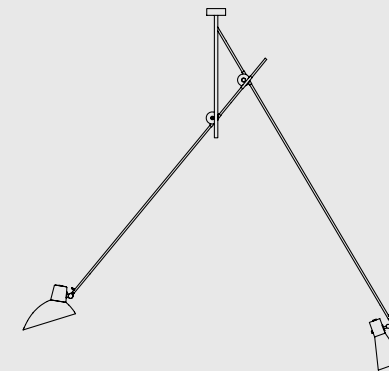

Typology	Suspension
Materials	Spun Aluminium Reflectors, Steel or Brass Structure
Dimensions	W256 x D1900 x H1800mm
Reflector diameter	ø 274mm
Weight	3.00kg
Control	On/Off Switch
Light source	2 x E27 LED 7W (53W Max, 806lm (1612lm Total), 2700K Dimmable Bulbs Included



Item Code	Description
T02-S21-00BB	Black Structure, Black Reflectors
T02-S21-00WB	Black Structure, White and Black Reflectors
T02-S21-00BR	Black Structure, Black and Red Reflectors
T02-S21-01LY	Mondrian Structure, Blue and Yellow Reflectors
T02-S21-01BB	Brass Structure, Black Reflectors
T02-S21-01BW	Brass Structure, Black and White Reflectors

Model 237/1

Gino Sarfatti, 1959/2018

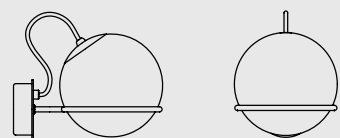

Typology	Wall
Materials	Opaline Glass Diffuser, Steel Structure
Dimensions	W140 x D203 x H150mm
Diffuser diameter	ø 140mm
Control	Available with On/Off Switch
Light source	1 x E14 LED 4.5W (60W Max), 470lm, 2700K Dimmable Bulb Included



Item Code	Description	Weight
T08-W31-S1B0	1 Opaline Sphere, Black Mount	0.85kg
T08-W31-S1D0	1 Opaline Sphere, Champagne Mount	0.85kg
T08-W3S-S1B0	1 Opaline Sphere, Black Mount with Switch	1.02kg
T08-W3S-S1D0	1 Opaline Sphere, Champagne Mount with Switch	1.02kg

INFO

Model 237/2

Gino Sarfatti, 1959/2018

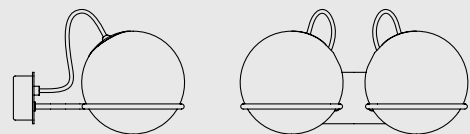

Typology	Wall
Materials	Opaline Glass Diffuser, Steel Structure
Dimensions	W310 x D230 x H150mm
Diffuser diameter	ø 140mm
Weight	1.60kg
Light source	2 x E14 LED 4.5W (60W Max) 470lm (940lm Total), 2700K Dimmable Bulbs Included



Item Code	Description
T08-W31-S2B0	2 Opaline Spheres, Black Mount
T08-W31-S2D0	2 Opaline Spheres, Champagne Mount

Model 238/1

Gino Sarfatti, 1959/2018

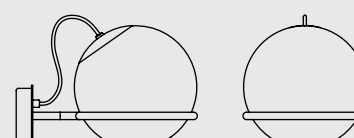

Typology	Wall
Materials	Opaline Glass Diffuser, Steel Structure
Dimensions	W200 x D300 x H210mm
Diffuser diameter	ø 200mm
Control	Available with On/Off Switch
Light source	1 x E27 LED 7W (60W Max), 806lm, 2700K Dimmable Bulb Included



Item Code	Description	Weight
T08-W21-M1B0	1 Opaline Sphere, Black Mount	1.55kg
T08-W21-M1D0	1 Opaline Sphere, Champagne Mount	1.55kg
T08-W2S-M1B0	1 Opaline Sphere, Black Mount with Switch	1.75kg
T08-W2S-M1D0	1 Opaline Sphere, Champagne Mount with Switch	1.75kg

INFO

Model 238/2

Gino Sarfatti, 1959/2018

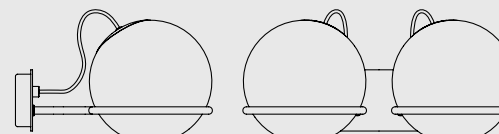

Typology	Wall
Materials	Opaline Glass Diffuser, Steel Structure
Dimensions	W450 x D320 x H210mm
Diffuser diameter	ø 200mm
Weight	3.00kg
Light source	2 x E27 LED 7W (60W Max), 806lm (1612lm Total), 2700K Dimmable Bulbs Included



Item Code	Description
T08-W21-M2B0	2 Opaline Spheres, Black Mount
T08-W21-M2D0	2 Opaline Spheres, Champagne Mount

Model 2109/12/14

Gino Sarfatti, 1959/2021

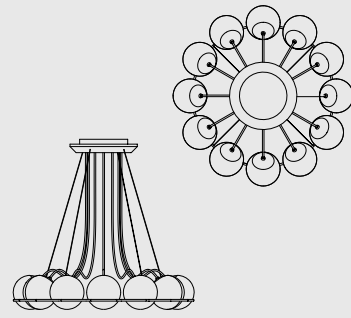

Typology	Suspension
Materials	Opaline Glass Diffuser, Steel Structure
Dimensions	ø 740 x H700-1600mm
Diffuser diameter	ø 140mm
Weight	11.40kg
Cable Length	1800mm
Light source	12 x E14 4.5W (60W Max), 470lm (5640lm Total), 2700K Dimmable Bulbs Included



Item Code	Description
T08-S31-SCB0	12 Opaline Spheres, Black Structure
T08-S31-SCD0	12 Opaline Spheres, Champagne Structure

Model 2109/24/14

Gino Sarfatti, 1959/2018

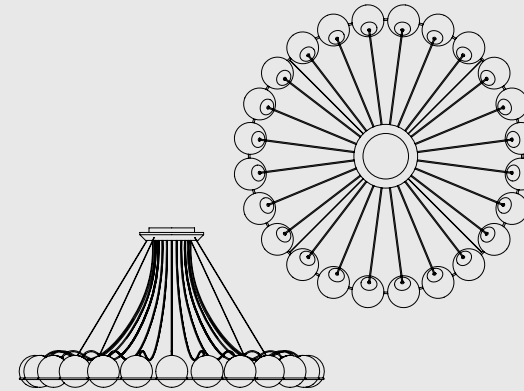

Typology	Suspension
Materials	Opaline Glass Diffuser, Steel Structure
Dimensions	ø 1340 x H70-1800mm
Diffuser diameter	ø 140mm
Weight	21.20kg
Cable Length	1800mm
Light source	24 x E14 LED 4.5 W (60W Max), 470lm (11280lm Total), 2700K Dimmable Bulbs Included



Item Code	Description
T08-S31-SOB0	24 Opaline Sphere, Black Structure
T08-S31-SOD0	24 Opaline Spheres, Champagne Structure

INFO

Model 2109/16/14

Gino Sarfatti, 1959/2018

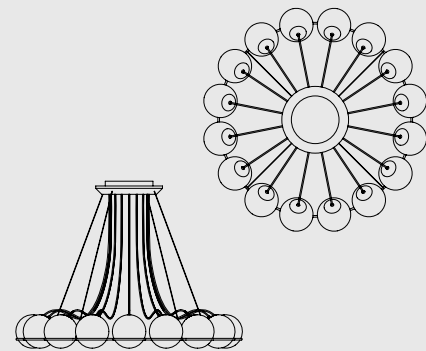

Typology	Suspension
Materials	Opaline Glass Diffuser, Steel Structure
Dimensions	ø 950 x H700-1800mm
Diffuser diameter	ø 140mm
Weight	14.80kg
Cable Length	1800mm
Light source	16 x E14 LED 4.5W (60W Max), 470lm (7520lm Total), 2700K Dimmable Bulbs Included



Item Code	Description
T08-S31-SGB0	16 Opaline Spheres, Black Structure
T08-S31-SGD0	16 Opaline Spheres, Champagne Structure

INFO

Model 2109/16/20

Gino Sarfatti, 1959/2018

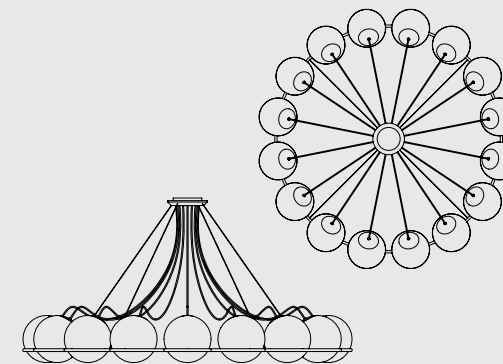

Typology	Suspension
Materials	Opaline Glass Diffuser, Steel Structure
Dimensions	ø 1400 x H70-1800mm
Diffuser diameter	ø 200mm
Weight	26.20kg
Cable Length	1800mm
Light source	16 x E27 LED 7W (60W Max), 806lm (12896lm Total), 2700K Dimmable Bulbs Included



Item Code	Description
T08-S21-MGB0	16 Opaline Spheres, Black Structure
T08-S21-MGD0	16 Opaline Spheres, Champagne Structure

Model 2042/3

Gino Sarfatti, 1963/2020

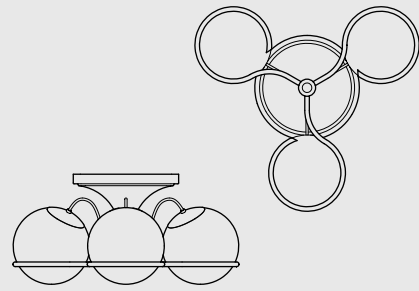

Typology Ceiling
Materials Opaline Glass Diffuser, Steel Structure
Dimensions ø 550 x H290mm
Diffuser Diameter ø 200mm
Light source 3 x E27 LED 7W (60W Max)
 806lm (2418lm Total) , 2700K
 Dimmable Bulbs Included



Item Code	Description
T08-C21-M3B0	3 Opaline Spheres, Black Mount
T08-C21-M3D0	3 Opaline Spheres, Champagne Mount

SB Cinquantotto

Carlo Santi & Vittorio Borachia, 1958/2019

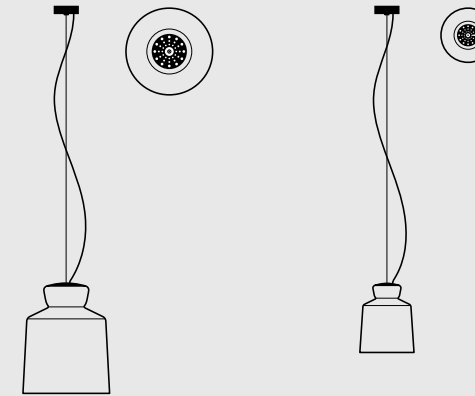

Typology Suspension
Materials Opaline Glass Diffuser, Steel Structure
Dimensions ø 320 x H410mm / ø 200 x H260mm
Weight 4.10kg / 1.30kg
Light source 1 x LED Bulb
 Dimmable Bulb Included



Item Code	Description	Wattage Max	Socket
T10-S21-00BW	32cm Diameter	60W	E27
T10-S31-S0BW	20cm Diameter	40W	E14

INFO

Model 2042/6

Gino Sarfatti, 1959/2019

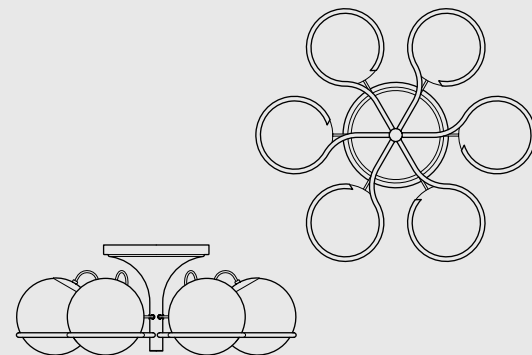

Typology Ceiling
Materials Opaline Glass Diffuser, Steel Structure
Dimensions ø 650 x H290mm
Diffuser diameter ø 200mm
Weight 9.40kg
Light source 6 x E27 LED 6W, 806lm (4836lm Total), 2700K
 Dimmable Bulbs Included



Item Code	Description
T08-C21-M6B0	6 Opaline Spheres, Black Mount
T08-C21-M6D0	6 Opaline Spheres, Champagne Mount

INFO

Model 2050

Franco Albini & Franca Helg, 1963/2021

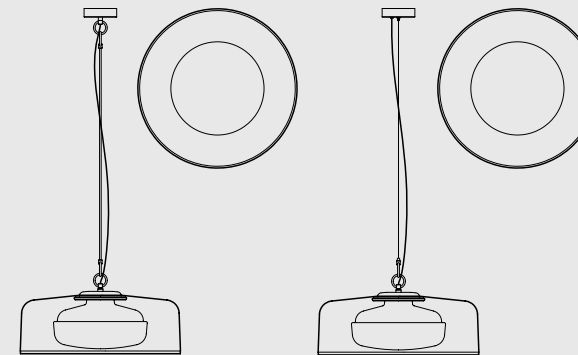

Typology Suspension
Materials Opaline Glass Diffuser, Methacrylate Diffuser, Steel Structure
Dimensions ø 590 x 296mm
Diffuser diameter ø 590mm
Light source 1 x E27 LED 11W, 1521lm, 2700K
 Dimmable Bulb Included



Item Code	Description	Installed Height	Cable Length	Weight
T12-S21-000E	Rod Suspension, Jade Diffuser	1250mm		7.70kg
T12-S21-000N	Rod Suspension, Smoke Diffuser	1250mm		7.70kg
T12-S21-W00E	Wire Suspension, Jade Diffuser	450-3400mm	3000mm	7.60kg
T12-S21-W00N	Wire Suspension, Smoke Diffuser	450-3400mm	3000mm	7.60kg

Model 2065

Gino Sarfatti, 1950/2016

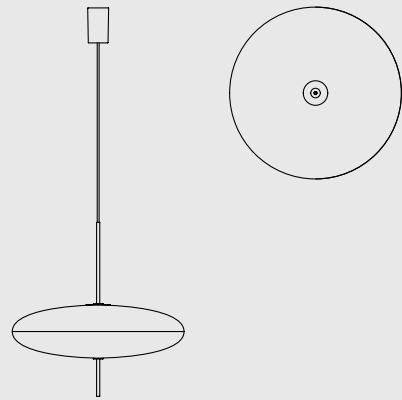

Typology Suspension
Materials Opaline Methacrylate Diffusers, Aluminium Hardware
Dimensions ø 538 x 546mm
Diffuser diameter ø 538mm
Weight 2.70kg
Cable Length 3000mm
Light source 5 x E14 LED 4.5W (12W Max), 470lm (2350lm Total), 2700K
 Dimmable Bulbs Included



Item Code	Description
T01-S31-0BBW	Black & White Diffuser, Black Hardware, Black Cable
T01-S31-0BWW	White Diffuser, Black Hardware, Black Cable
T01-S31-0WWW	White Diffuser, Black Hardware, White Cable

Model 537

Gino Sarfatti, 1950/2019

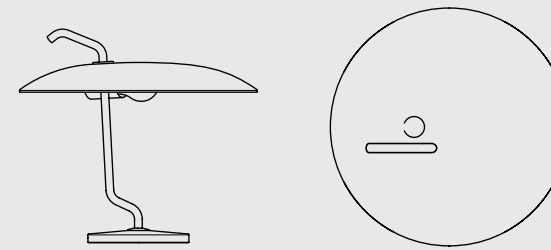

Typology Table
Materials Spun Aluminium reflector, Brass Structure, Marble Base
Dimensions ø 400 x H360mm
Reflector diameter ø 400mm
Weight 2.45kg
Control On/Off Switch
Light source 1 x E27 LED 4.5W (60W Max)
 Non-dimmable Bulb Included



Item Code	Description
T09-T21-001B	Brass Structure, Black Reflector, White Marble Base
T09-T21-001W	Brass Structure, White Reflector, White Marble Base
T09-T21-00BB	Black Structure, Black Reflector, Black Marble Base

INFO

Model 2065 Wall

Gino Sarfatti, 1955/2021

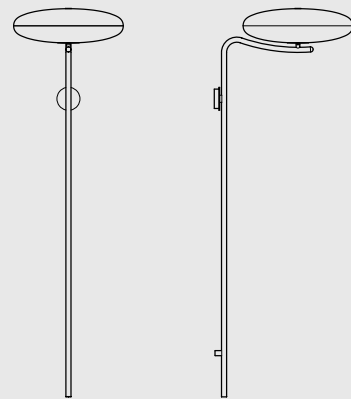

Typology Wall
Materials Opaline Methacrylate Diffusers, Steel Structure
Dimensions W538 x D680 x H1900mm
Diffuser diameter ø 538mm
Light source 5 x E14 LED 4.5W (12W Max), 470lm (2350lm Total), 2700K
 Dimmable Bulbs Included



Item Code	Description	Weight	Cable Length
T01-W31-0BWW	White Diffuser, Black Structure	5.10kg	
T01-W31-POWW	White Diffuser, Black Structure with plug	5.30kg	2400mm

INFO

Model 548

Gino Sarfatti, 1951/2013

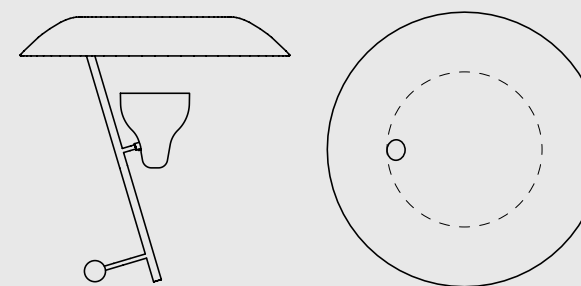

Typology Table
Materials Brass Structure, Opaline Methacrylate Diffuser
Dimensions ø 500 x 500mm
Diffuser diameter ø 500mm
Weight 3.10kg
Control Touch Dimmer
Light source Integrated LED 11W, 730lm, 2700K



Item Code	Description
T03-T12-00BG	Dark Burnished Brass with Grey Diffuser
T03-T12-00BO	Dark Burnished Brass with Orange Diffuser
T03-T12-001A	Polished Brass with Azure Diffuser
T03-T12-001G	Polished Brass with Grey Diffuser

Model 566

Gino Sarfatti, 1956/2020

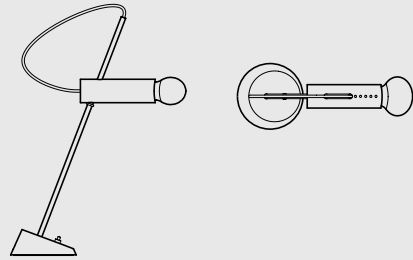

Typology	Table
Materials	Aluminum Body, Steel Stand, Cast Alloy Base
Dimensions	W140 x D374 x H506mm
Cable length	1500mm
Weight	2.10kg
Control	On/Off Switch
Light source	1 x B22 LED 8W (8W Max), 700lm, 2700K Dimmable Bulb Included



Item Code	Description
TII-T41-000B	Black
TII-T41-000G	Polished

Model 1063

Gino Sarfatti, 1954/2013

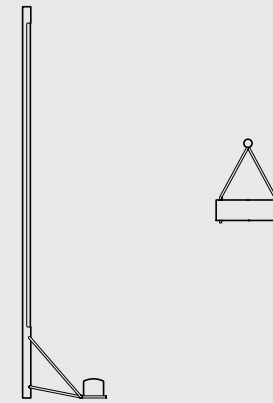

Typology	Floor
Materials	Aluminium Structure, Steel Counterweight
Dimensions	W350 x D460 x H2150mm
Weight	10.0kg
Control	Rotary Dimmer
Light source	Integrated LED 57W, 2500lm, 2700-5000K



Item Code	Description
T05-F12-000B	Black with White Base

Model 2129

Gino Sarfatti, 1969/2013

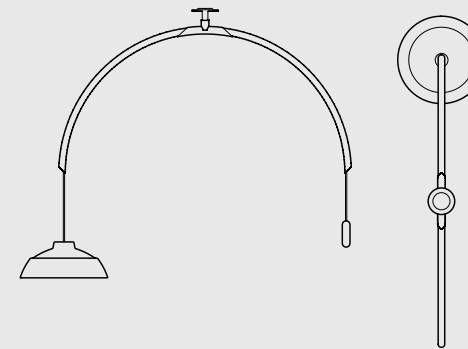

Typology	Suspension
Materials	Aluminium Reflectors, Methacrylate and Brass Structure
Dimensions	W400 x D1450 x H1000-2400mm
Reflector Diameter	ø 400mm
Weight	4.60kg
Control	Foot Switch
Light source	Integrated LED 25W, 1600lm, 2700K



Item Code	Description
T07-S12-00BW	White & Grey Shade, Methacrylite Structure



Astep is a lighting company built on design, innovation and sustainability carefully balancing purpose and profits. With an eye firmly focused on minimizing its impact on the environment and on caring for its stakeholders, Astep brings back to life timeless, revolutionary lamps of the past while envisaging new classics of today.

Astep ApS

Esplanaden 6
1263 Copenhagen
Denmark

+45 70 70 50 01

www.asteptdesign.com

Astep reserves the right to introduce any
changes to its own models without prior notice

For sales inquiries please contact
sales@asteptdesign.com



Copyright Astep 2021

PHOTOGRAPHY

Heidi Lerkenfeldt

Jonas Bjerre-Poulsen (p. 106, 114, 118)

Sistema Manifesto (p. 24, 25)

Hasse Nielsen (p. 6)

Mikkel Vigholt (p. 27, 31, 32, 100)

STYLING

Pernille Vest

Sofie Brünner (p. 106, 114, 118)

PROJECT DIRECTOR

Yasmin Edgecombe

GRAPHIC DESIGN

Sigrid Gry Laursen

SPECIAL THANKS

101 cph, Aytm, Anna C. N. Meyer, Anne Brandhøj, Anne Bystrup, Birute Si, C/RO Copenhagen, Doriana De Petris, Birgitte Due Madsen, Fjord Interior, Frama, Jonas Trampedach, Josefine Winding, Karakter, Karen Bennicke, Lerkenfeldt Gallery, Linnea Ek Blæhr, Louise Roe, Massproductions, Maria Enæs, Menu, Vang Stensgaard, Montana, Munk Collective, New Works, Ole Mynster Herold, Patrizia Cassina, Paustian, Robynn Storgaard, Room by Sarah, Rue Verte, Sacre Coeur Design Shop, Salvatori, Society Limonta, Stine Mikkelsen, Søren Jacobsen, Thonet, The Posterclub, Thora Finnsdóttir, Tine K Home.



Collection

Gino Sarfatti

Vittoriano Viganò

Carlo Santi

Vittorio Borachia

Franco Albini

Franca Helg

Alfredo Häberli

Francisco Gomez Paz

Francesco Faccin

David Thulstrup



astep®