

# MARKET SET

LA LUMIÈRE A DU STYLE

COLLECTION 2022

# SOMMAIRE

RIVAGE	10
COSINESS	16
FORMENTERA	26
ILO-ILO	30
MOKUZAÏ	36
MARRAKECH	44
PORTINATX	52
SCREEN	66
SONIA LAUDET	80
SINGAPOUR	88
MEKKO	116
GATSBY	130
LORD	140
IMPERIAL	142
PRECIEUX	143
SPY	146
WATERLILY	147



# MANUFACTURE FRANCE FABRICATION FRANCE

MARKET SET est une marque du groupe COREP LIGHTING, fabricant et CRÉATEUR de Luminaires en France, depuis 1970 à Bègles en Gironde.

MARKET SET développe des gammes inspirées des dernières tendances, des nouveaux usages et des besoins de ses différents marchés.

À ce titre, son équipe de designers met au point des collections spécifiques chaque année. Afin de protéger et pérenniser ce savoir-faire, MARKET SET dépose ses catalogues et ses modèles pour mieux garantir l'originalité des produits proposés. MARKET SET se réserve ainsi le droit d'utiliser ces outils et son antériorité à des fins légales pour toujours mieux satisfaire ses clients et leur assurer la primeur et la différence de ses gammes.

MARKET SET souhaite illustrer plus que jamais son statut de créateur de Lumières.

*Market Set is a brand of Corep Lighting Group, manufacturer and designer of decorative lights in France, since 1970, in Bègles in Gironde.*

*Market Set has been developing ranges inspired from last trends, new uses and needs for different markets. As such, its team of designers develops specific collections each year. To protect and perpetuate this know-how, Market Set registers its catalogues and its models to assure the originality of its products. Market Set reserves the right to use those means and its anteriority to legal purposes, in order to even better satisfy its customers and to guarantee them scoops and differences in its ranges.*

*Market Set wishes to materialize more than ever its status of designer of Lights.*



@marketsetofficiel

Découvrez notre tout nouveau site internet  
[www.marketset.fr](http://www.marketset.fr)  
en flashant le QR code ci-dessous.

*Discover our brand new website  
[www.marketset.fr](http://www.marketset.fr)  
by flashing the QR code below.*

Vous pouvez créer votre espace personnel,  
consulter les stocks, élaborer vos wishlists,  
préparer et suivre vos commandes  
pour les déclencher au moment voulu.

*You can create your personal space,  
consult stocks, elaborate your wishlists,  
prepare and follow up your orders  
to trigger them at the right time.*





# RIVAGE

MARKET SET est fier de s'associer à la société française Culture iN, créateurs d'une matière exceptionnelle à base de lin français, le Varian® pour sa nouvelle gamme éco-responsable RIVAGE.

Le lin est une matière première écologique reconnue dans le monde entier pour être une plante dont la culture ne nécessite pas d'irrigation particulière, est biodégradable avec un impact carbone positif. Culture iN associe ce lin à du PLA obtenu à partir d'amidon de maïs, et fabrique ainsi un tissu aux propriétés structurales étonnantes, et pouvant être thermoformé. Puisant son inspiration de la nature et de la côte Atlantique, l'équipe design MARKET SET a dessiné une gamme élégante, légère et envolée, qui associe les tons naturels du lin et du chêne massif à des détails sophistiqués en finition laiton brossé. Les ondulations des feuilles de Varian®, obtenues par thermoformage, évoquent les traces de l'océan se retirant du sable.

*MARKET SET is proud to associate with the French society Culture iN, creator of an amazing French linen based material, the Varian® for her new range : RIVAGE.*

*Linen is an ecologic primary material all over the world recognized for a non needed irrigation plant. It is biodegradable with a positive carbon impact. Culture iN associates linen to biodegradable PLA obtained with corn starch, and make an interesting structural properties fabric with, and could be thermoformed. Drawing its inspiration from nature and Atlantic coast, The MARKET SET designers team designed an elegant Collection, light and soaring, which associates natural tones of linen, and massif oakwood to sophisticated details and a brushed brass finish. The Varian® sheets wavy lines, obtained from thermoforming, evoke the traces of the ocean receding from the sand.*

656042  
656043  
656044







8

656045  
656046  
656047



656048



656049

9



656050



Design  
MARKET SET

80217//80218

Suspension 2 lumières. Superposition de 4 abat-jour en matière Varian® composée de fils de lin et de résine végétale. diffuseur en verre opale, en bois de chêne et laiton brossé équipée d'un cordon textile. Livrée avec un set d'ampoule R7S et GU10, blanc chaud + blanc froid.

Pendant light. Varian® material shades overlay. Oak wood, brushed brass and Opal glass diffuser, delivered with a textile cord. Delivered with a set of R7S and GU10 bulbs, warm white + cold white.

M  
L

80217  1R7S // 8W max. + 1GU10 // 5W max.

80218  1R7S // 8W max. + 1GU10 // 5W max.

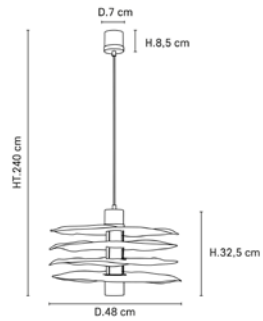

80217 - 656048  
naturel

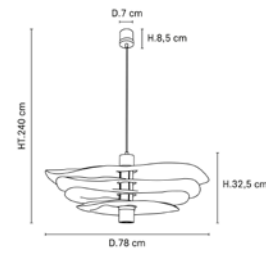

80218 - 656049  
naturel



Design  
MARKET SET

Applique 1 lumière. Superposition de 4 abat-jour en matière Varian. Patère déportée en chêne clair et métal finition laiton brossé. Diffuseur tube en verre opale. Livrée avec un set d'ampoule R7S et GU10, blanc chaud + blanc froid.

Wall light. 4 Varian® shades overlay. Meatl and clair oak wood deported peg. Brushed brass finish. Opal glass tube diffuser. Delivered with a set of R7S and GU10 bulbs, warm white + cold white.

S

80216  1R7S // 8W max. + 1GU10 // 5W max.

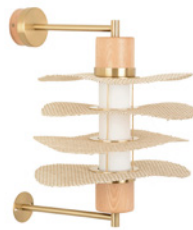
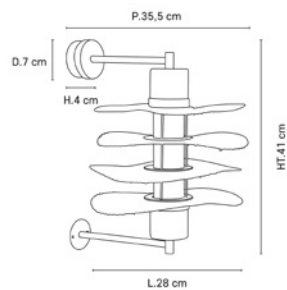

656050  
naturel



Design  
MARKET SET

Suspension 1 lumière avec abat-jour en matière Varian®. Equipée d'un cordon textile silicone, d'une bague en laiton brossé et d'un pavillon en métal sablé adaptable DCL.

Varian® pendant light shade. Delivered with a textile cord, brushed brass ring and sanded metal canopy. Adaptable DCL.

S/M/L

80219



E27 // 60W max.

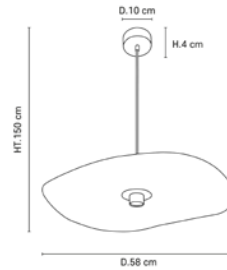

656042  
naturel

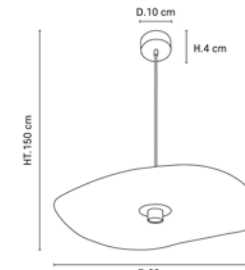

656043  
naturel

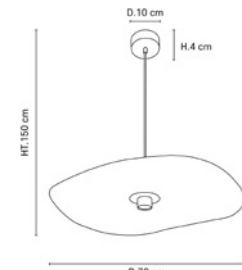

656044  
naturel



Design  
MARKET SET

Applique avec abat-jour en matière Varian. Equipée d'une patère murale en métal finition laiton brossé adaptable DCL.

Varian® wall light lampshade. Delivered with a metal wall base. Brushed brass finish. Adaptable DCL.

S/M/L

80220



E27 // 60W max.



656045  
naturel



656046  
naturel



656047  
naturel





# COSINESS

Retour aux seventies ! Habillée de la matière phare de la saison, la bouclette, la gamme COSINESS nous enveloppe de douceur et nous transporte dans les années 70 !

Elle nous remémore cet art de vivre et cette recherche constante du confort dans l'habitat par ses formes rebondies et sa matière bouclée que l'on a envie de caresser. Une gamme qui s'adapte à tous les intérieurs par sa sobriété et par le large choix de compositions possibles.

*Back to the seventies ! Wearing the flagship material of the season, the loop stich, The COSINESS Collection wrap us softly, and throwback us to the seventies !*

*It reminds us this way of life and the constant habitat's comfort research by rebunded shapes and its loop stich material we would like to cuddle. A Collection which is adaptable to every interiors by its sobriety and a large choices of possible compositions.*







14

PR503516



656085



PR503497

PR503515



15





Suspension 1 lumière avec abat-jour cylindre en tissu bouclette. Équipée d'un cordon textile et d'un pavillon en métal assorti adaptable DCL.

*Matt ceramic pendant light. Loop stitch cotton lampshade. Delivered with textile cord and metal canopy adaptable DCL.*

5618



E27 // 40W max.

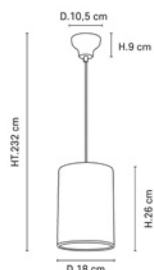

656087  
bouclette

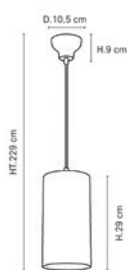

656085  
bouclette

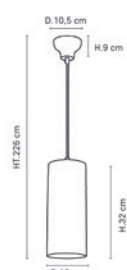

656086  
bouclette



80231

Suspension 3 lumières avec abat-jour cylindres en tissu bouclette. Équipée de cordons textiles et d'une réglette en métal assorti.

*Matt ceramic pendant light. Loop stitch cotton lampshade. Delivered with textile cords and metal fixture.*



80232

Suspension 5 lumières avec abat-jour cylindres en tissu bouclette. Équipée de cordons textiles et d'une réglette en métal assorti.

*Matt ceramic pendant light. Loop stitch cotton lampshade. Delivered with textile cords and metal fixture.*

80231



3XE27 // 40W max.



80232

5XE27 // 40W max.

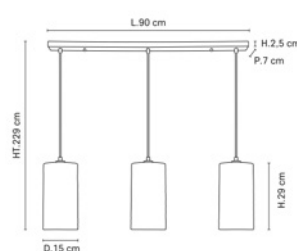

80231 - PR503513  
bouclette

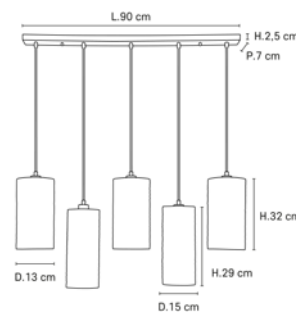

80232 - PR503514  
bouclette



80233

Suspension 5 lumières avec abat-jour cylindres en tissu bouclette. Équipée de cordons textiles et d'un pavillon en métal assorti.

*Matt ceramic pendant light. Loop stitch cotton lampshade. Delivered with textile cords and metal canopy.*



80234

Suspension 8 lumières avec abat-jour cylindres en tissu bouclette. Équipée de cordons textiles et d'un pavillon en métal assorti.

*Matt ceramic pendant light. Loop stitch cotton lampshade. Delivered with textile cords and metal canopy.*

80233



5XE27 // 40W max.



80234

8XE27 // 40W max.

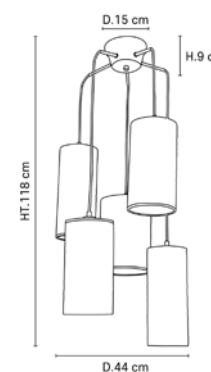

80233 - PR503515  
bouclette

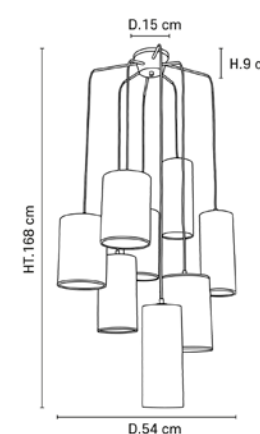

80234 - PR503516  
bouclette



Suspension 16 lumières avec abat-jour cylindres en tissu bouclette. Équipée de cordons textiles et d'un pavillon en métal assorti.

*Matt ceramic pendant light. Loop stitch cotton lampshade. Delivered with textile cords and metal canopy.*

80235



16XE27 // 40W max.

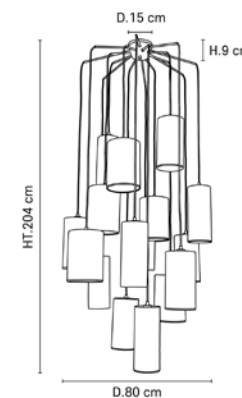

PR503517  
bouclette





# NEW COSINESS

Design  
MARKET SET

80227// 80228

Lampe en céramique mat. Abat-jour conique en coton bouclette. Équipée d'un cordon textile.

Matt ceramic table lamp with conical cotton loop stitch lampshade. Delivered with textile cord.

PR503498

80227



E27 // 60W max.



80228

E27 // 60W max.

Ampoule conseillée  
Recommended bulb

A60  
654313

3 188000 760036

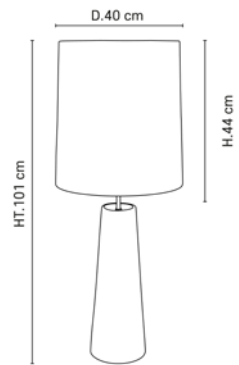

80227 - PR503497

blanc



80228 - PR503498

gris



18



19



# FORMENTERA

Un air de vacances et d'ode au bien être souffle sur la gamme FORMENTERA. Jouant sur l'accumulation d'abat-jour en matières naturelles, elle évoque tout un univers bohème chic sous influences méditerranéennes.

Le mix du bana et raffia, frangés à la main dans notre atelier, apportent chaleur, volume et donnent vie à ces pièces d'exception aux dimensions spectaculaires!

*A soft breeze of holiday feeling and wellbeing blows on the range FORMENTERA. Playing on the accumulation of lampshades made of natural materials, it evokes a bohemian chic universe with Mediterranean influences.*

*The mix of bana and raffia, hand-fringed in our workshop, brings warmth, volume and life to these exceptional pieces of spectacular dimensions!*

20

PR503492

21







655578 - Ø15

PR503488



PR503489



655579 - Ø13



655578 - Ø15



655580 - Ø18



PR503490



PR503491





# FORMENTERA

Design  
MARKET SET

Suspension 1 lumière avec abat-jour cylindre en bana et raphia frangé à la main. Equipée d'un cordon textile et silicone ainsi que d'un pavillon en métal assorti adpatable DCL.

*Pendant light with bana and fringed raffia cylinder lampshade. Matching textil and silicon electrical cord and DCL metal canopy.*

5616



E27 // 40W max.



Ampoule conseillée  
Recommended bulb  
A60  
654313



3 188000 760036

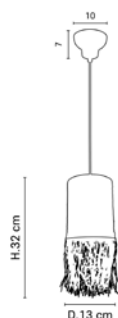

65579  
bana



65578  
bana



65580  
bana



26

80208

Suspension 3 lumières avec abat-jour cylindre en bana et raffia frangé. Équipée de cordelières textiles et silicone ainsi que d'une réglette en métal assorti.

*3-light bar pendant light with bana and raffia cylinder lampshades. Matching metal ceiling plate with textil and silicon electrical cord.*

Design

MARKET SET

80209

Suspension 5 lumières avec abat-jour cylindre en bana et raffia frangé. Équipée de cordelières textiles et silicone ainsi que d'une réglette en métal assorti.

*5-light bar pendant light with bana and raffia cylinder lampshades. Matching metal ceiling plate with textil and silicon electrical cord.*

80208



3XE27 // 40W max.



80209

5XE27 // 40W max.

Ampoule conseillée  
Recommended bulb  
A60  
654313



3 188000 760036

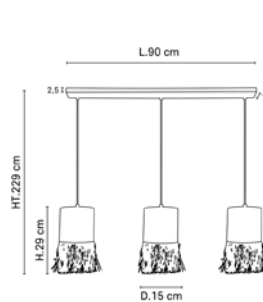

80208 - PR503488  
bana

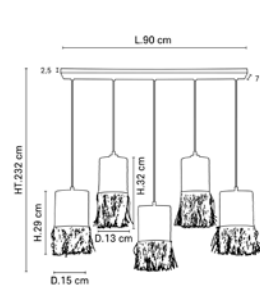

80209 - PR503489  
bana



80210

Suspension 5 lumières avec abat-jour cylindres en bana et raphia frangé. Équipée de cordelières textiles et silicone ainsi que d'un pavillon en métal assorti.

*5-light chandelier with bana and raffia cylinder lampshades. Matching metal canopy with textile and silicon cords included.*

Design

MARKET SET

80211

Suspension 8 lumières avec abat-jour cylindres en bana et raphia frangé. Équipée de cordelières textiles et silicone ainsi que d'un pavillon en métal assorti.

*8-light chandelier with bana and raffia cylinder lampshades. Matching metal canopy with textile and silicon cords included.*

80210



5XE27 // 40W max.



80211

8XE27 // 40W max.

Ampoule conseillée  
Recommended bulb  
A60  
654313



3 188000 760036

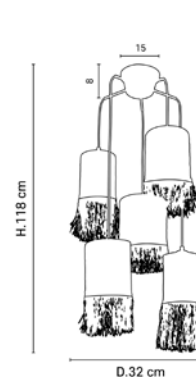

80210 - PR503490  
bana

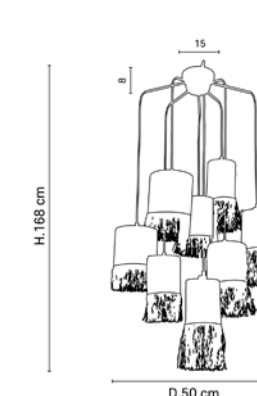

80211 - PR503491  
bana



27

Design

MARKET SET

Suspension 16 lumières avec abat-jour cylindres en bana et raphia frangé. Équipée de cordelières textiles et silicone ainsi que d'un pavillon en métal assorti.

*16-light chandelier with bana and raffia cylinder lampshades. Matching metal canopy with textile and silicon cords included.*

80212



16XE27 // 40W max.



Ampoule conseillée  
Recommended bulb  
A60  
654313



3 188000 760036

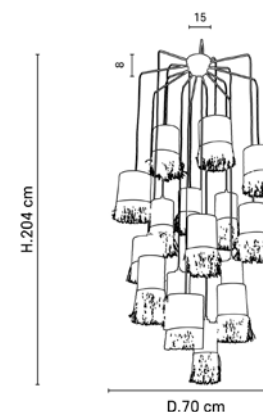

PR503492  
bana



590390



28

# ILO-ILO

Une pluie de lumière!  
Si épuré mais toujours surprenant.

*A rain of light!*  
*So simple, but still so surprising.*

590389



29

# ILO - ILO

Suspension 1 lumière avec abat-jour cylindre en verre transparent. Équipée d'une cordelière textile et d'un pavillon en métal assorti.

*Pendant light with clear glass cylinder lampshade. Matching metal canopy and textile cord included.*

**Ampoule conseillée**  
Recommended bulb

**A60**  
654315



**T32**  
654319



**ST64**  
654321



80029



E27 // 40W max.



30

80030

Suspension 3 lumières avec abat-jour cylindres en verre transparent. Équipée de cordelières textiles et d'une réglette en métal assorti.

*3-light pendant light with clear glass cylinder lampshades. Matching metal ceiling sealing and textile cords included.*



80031

Suspension 5 lumières avec abat-jour cylindres en verre transparent. Équipée de cordelières textiles et d'une réglette en métal assorti.

*5-light pendant light with clear glass cylinder lampshades. Matching metal ceiling sealing and textile cords included.*

80030



3XE27 // 40W max.



80031

5XE27 // 40W max.

**Ampoule conseillée**  
Recommended bulb

**ST64**  
654321



**Ampoule conseillée**  
Recommended bulb

**X1 X2 X2**  
PR651025



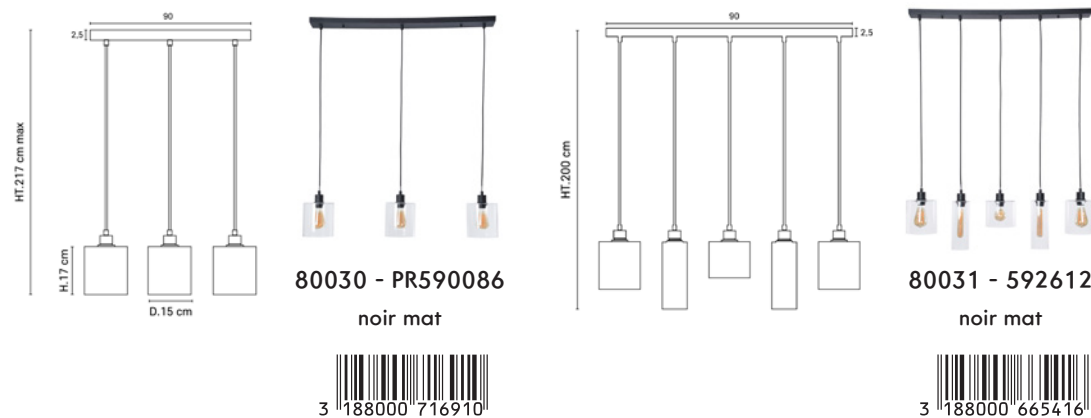

80032

Suspension 5 lumières avec abat-jour cylindres en verre transparent. Équipée de cordelières textiles et d'un pavillon en métal assorti.

*5-light chandelier with clear glass cylinder lampshades. Matching metal canopy and textile cords.*



80033

Suspension 8 lumières avec abat-jour cylindres en verre transparent. Équipée de cordelières textiles et d'un pavillon en métal assorti.

*8-light chandelier with clear glass cylinder lampshades. Matching metal canopy and textile cords.*

80032



5XE27 // 40W max.



80033

8XE27 // 40W max.

**Ampoule conseillée**  
Recommended bulb

**X1 X2 X2**  
PR651025



**Ampoule conseillée**  
Recommended bulb

**X3 X2 X3**  
PR651026



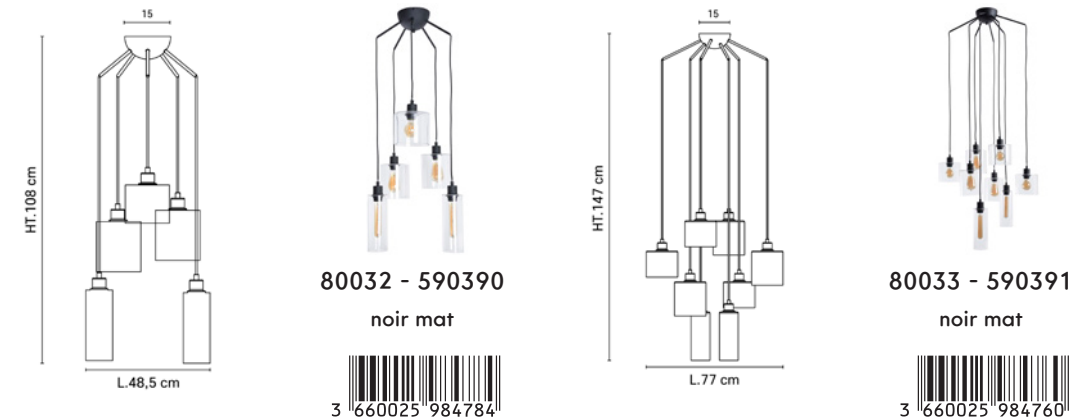

Suspension 16 lumières avec abat-jour cylindres en verre transparent. Équipée de cordelières textiles et d'un pavillon en métal assorti.

*16-light chandelier with clear glass cylinder lampshades. Matching metal canopy and textile cords.*

80034



16XE27 // 40W max.



**Ampoule conseillée**  
Recommended bulb

**X5 X6 X5**  
PR651027



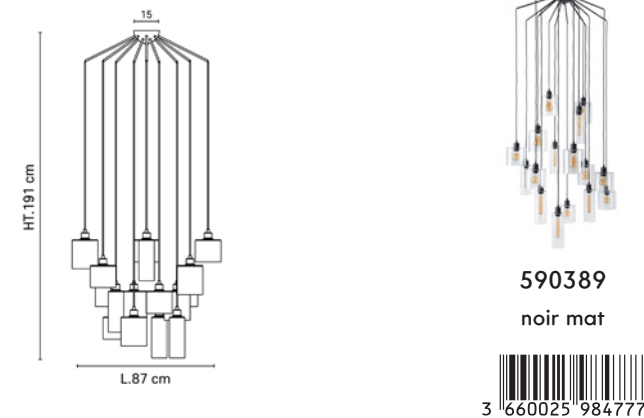

31



# MOKUZAI

Résolument masculine, notre nouvelle gamme MOKUZAI est une véritable ode à la sophistication.

Les suspensions et abat-jour, fabriqués dans notre atelier en France, sont sobres d'apparence, mais surprennent par la finesse de leur jacquard intérieur, dont le motif évoque les éléments d'un paysage onirique japonais. Un diffuseur conique en papier Murano, rappelant le papier de riz, permet à la fois de créer un jeu de réflecteur dans l'abat-jour pour intensifier l'éclairage, mais aussi de diffuser une lumière douce dans la pièce. Les bases en frêne, fabriquées au Portugal, adoptent des formes douces et fuselées sublimes par des teintes de noyer, inspirées des codes vintage du design scandinave des années 60.

La Gamme MOKUZAI propose les pièces parfaites pour les adeptes de design épuré avec un style sobre et contemporain, tout en apportant une touche vintage.

*Definitely male, our new MOKUZAI Collection is a veritable hymn to sophistication.*

*The pendant lights and shades, made in our factories in France, are visually sobers, but, surprising by the internal jacquard fabric delicacy, whose the motif evokes elements of a dreamlike japanese landscape. A Murano paper conic diffuser, evoking rice paper, could in one hand, create a reflexion game inside the shade to intensify the light, and in an other hand, diffuse a soft light in the room. The ash wood bases, made in Portugal, adopt soft and well shaped sublimated by walnut wood tints, inspired vintage cods from the 60'scandinavian design.*

*The MOKUZAI Collection suggests perfect pieces for sleek design followers, with a contemporary and sober style, while bringing a vintage touch.*





656056



34

656054



PR590318



656055

35



# NEW MOKUZAI



80221// 80222

Suspension forme conique bi-matière avec cover en papier murano. Équipée d'un cordon textile et d'un pavillon en métal peint adaptable DCL.

Conical bi-material pendant light with murano paper cover and a textile cord and painted metal canopy. Adaptable DCL.

S/M

80221  
80222



E27 // 40W max.  
E27 // 40W max.



Ampoule conseillée  
Recommended bulb

A60  
654314

G95  
654326

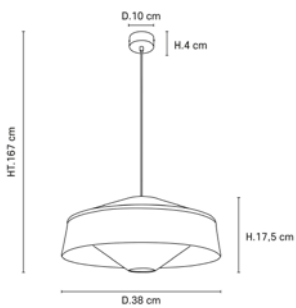

80221 - 656053  
suna

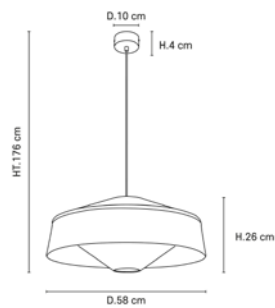

80222 - 656054  
suna



Applique forme conique bi-matière avec cover en papier murano. Équipée d'une base ronde en métal peint adaptable DCL.

Conical bi-material wall light with murano paper cover and a painted metal round base. Adaptable DCL.

80224



E27 // 40W max.



Ampoule conseillée  
Recommended bulb

A60  
654314

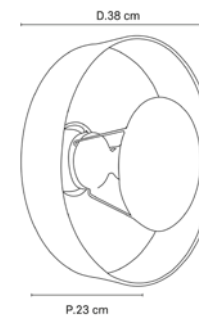

656056  
suna



Suspension 3 lumières forme conique bi-matière avec cover en papier murano. Équipée d'un cordon textile et d'un pavillon en métal peint adaptable DCL.

3-light conical bi-material pendant light with murano paper cover and a textile cord and painted metal canopy. Adaptable DCL.

L

80223



3XE27 // 15W max.



Ampoule conseillée  
Recommended bulb

G95  
654326

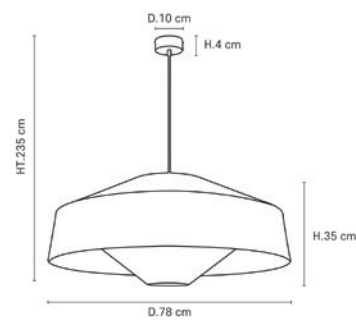

656055  
suna



656055





**NEW MOKUZAI**

Design  
MARKET SET

**80225// 80226**

Lampe en bois massif. Abat-jour forme cylindre en tissu dépolluant ou abat-jour conique bi-matière, équipé d'un cover en papier murano. Cordon textile et interrupteur.

Massive wood table lamp and depolluting fabric cylinder lampshade or bi-material conical lampshade and a murano paper cover. Textile cord and switch.

80225



E27 // 60W max.



80226

E27 // 60W max.

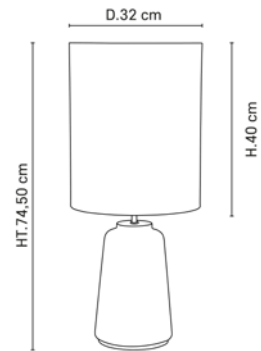

80225 - PR503499  
blanc

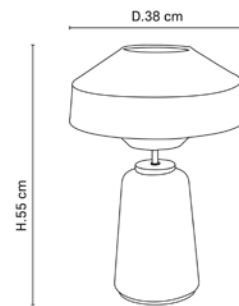

80225 - PR590318  
suna



Ampoule conseillée  
Recommended bulb



A60  
654313



38

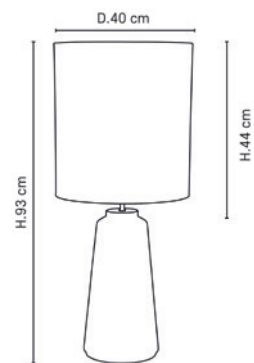

80226 - PR503500  
blanc

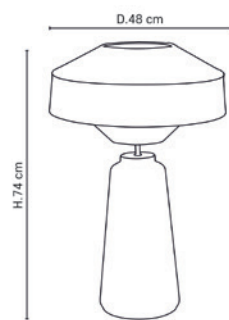

80226 - PR590319  
suna



PR503499



39



# MARRAKECH

Inspirée de la forme des lanternes marocaines à facettes, la gamme MARRAKECH nous fait voyager au cœur d'un riad luxuriant.

En hommage au savoir-faire artisanal des vanniers marocains, la matière bana est un doux tissage de raphia et de fibres de bananier, frangée avec soin à la main dans notre atelier rendant chaque produit unique. L'abat-jour géométrique s'habille de lins lavés, dans une sélection harmonieuse de couleurs chaudes qui évoquent les épices du marché de la Médina.

*Inspired by the shape of Moroccan faceted lanterns, the MARRAKECH range takes us on a journey to the heart of a luxurious riad.*

*As a tribute to the craftsmanship of Moroccan basket makers, the bana material is a soft weaving of raffia and banana tree fibers, carefully fringed by hand in our workshop making each product unique. The geometrical lampshade is dressed in washed linen, in a harmonious selection of warm colours that evoke the spices of the Medina market.*

655564  
655570







655571



655577

42



656382



655562

43



# MARRAKECH

Design  
MARKET SET

Suspension pentagone empilement 2 abat-jour en lin lavé et cylindre en bana et raphia frangé. Equipée d'un cordon textile et d'un pavillon en métal assorti adaptable DCL.

*Pentagonal pendant light stacking 2 washed linen lampshades and cylinder in bana and fringed raffia. Delivered with a textile cord and a matching metal canopy DCL adaptable.*

S

5612



E27 // 60W max.

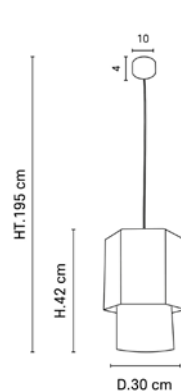

44

Design  
MARKET SET

Suspension heptagone empilement 3 abat-jour en lin lavé et cylindres en bana et raphia frangé. Equipée d'un cordon textile et d'un pavillon en métal assorti adaptable DCL.

*Heptagon pendant light stacking 3 washed linen lampshades and cylinders in bana and fringed raffia. Delivered with a textile cord and a matching metal canopy DCL adaptable.*

L

5614



E27 // 60W max.

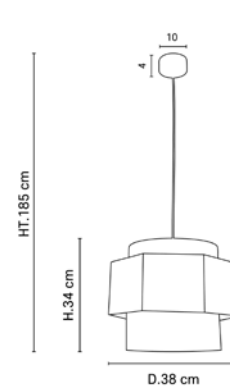

45

Design  
MARKET SET

Suspension pentagone empilement 2 abat-jour en lin lavé et cylindre en bana et raphia frangé. Equipée d'un cordon textile et d'un pavillon en métal assorti adaptable DCL.

*Pentagonal pendant light stacking 2 washed linen lampshades and cylinder in bana and fringed raffia. Delivered with a textile cord and a matching metal canopy DCL adaptable.*

M

5613



E27 // 60W max.

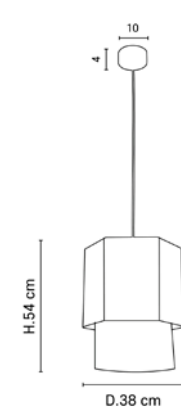

Design  
MARKET SET

Suspension octogone empilement 3 abat-jour en lin lavé et cylindres en bana et raphia frangé. Equipée d'un cordon textile et d'un pavillon en métal assorti adaptable DCL.

*Octagon pendant light stacking 3 washed linen lampshades and cylinders in bana and fringed raffia. Delivered with a textile cord and a matching metal canopy DCL adaptable.*

XL

5615



E27 // 60W max.

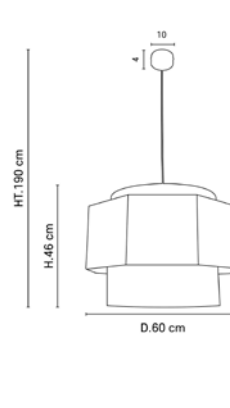



# NEW MARRAKECH

Design  
MARKET SET

Applique 2 lumières demi-hexagone empilement 3 abat-jour en lin lavé et demi cercles en bana et raphia frangé.  
2-light half-hexagon wall light stacking 3 washed linen lampshades and half-cylinders in bana and fringed raffia.

5619



2XE27 // 40W  
max.



Ampoule conseillée  
Recommended bulb

G80  
654322

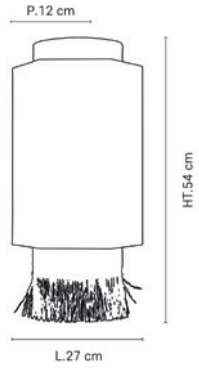

656381  
kaki



656382  
massala



656384  
curry



656383  
épices



46



47





# PORTINATX

Entre son savoir-faire traditionnel et ses destinations de rêve, la Méditerranée nous inspire, et nous laisse rêveurs...

Ces lampes en céramique bosselée effet terracotta et abat-jour en bana, nous évoquent l'authenticité d'une maison de vacances familiale, remplie de souvenirs et d'objets vintages artisanaux...

*Between its traditional know-how and its dream destinations, the Mediterranean inspires us and leaves us dreaming...*

*These dented ceramic lamps with terracotta effect and lampshade made in natural bana, evoke the authenticity of a family holiday home, full of memories and vintage handcrafted objects...*







PR500316





# PORTINATX

Design  
MARKET SET

Applique forme cylindre en bana, équipé d'un disque en céramique bosselée mat et d'une patère murale en métal adaptable DCL.

*Cylinder bana wall light, delivered with a ceramic mat dented disc and a metal wall base adaptable DCL.*

NEW

S

5620



E27 // 60W max.

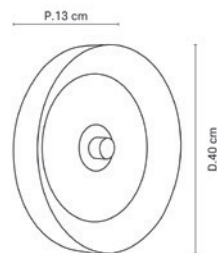

656386  
blanc



656385  
terracotta



52

Design  
MARKET SET

Applique forme cylindre en bana, équipé d'un disque en céramique bosselée mat et d'une patère murale en métal adaptable DCL.

*Cylinder bana wall light, delivered with a ceramic mat dented disc and a metal wall base adaptable DCL.*

NEW

L

5621



E27 // 60W max.

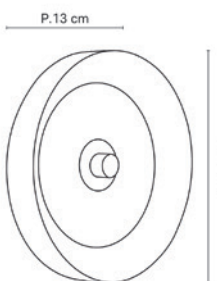

656388  
blanc



656387  
terracotta



53

Design  
MARKET SET

Lampe en céramique mat. Abat-jour forme cylindre en bana et raphia.

*Matt ceramic table lamp with cylinder bana and raffia lampshade.*

Dispo  
Janvier 2022  
Available  
January 2022

M

80213



E27 // 60W max.

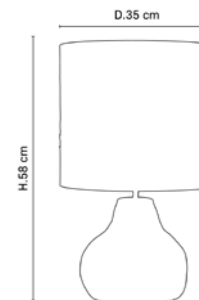

PR503493  
terracotta



PR590316  
blanc



NEW

Design  
MARKET SET

Lampe en céramique mat. Abat-jour forme cylindre en bana et raphia.

*Matt ceramic table lamp with cylinder bana and raffia lampshade.*

Dispo  
Janvier 2022  
Available  
January 2022

L

80214



E27 // 60W max.

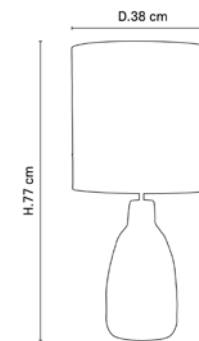

PR503494  
terracotta



PR590317  
blanc



NEW



# SCREEN CANNAGE

Influencée par la technique ancestrale japonaise du Yakisugi consistant à brûler le bois en surface pour le protéger et le faire durer dans le temps, cette démarche de durabilité donne un résultat plus graphique que jamais. Notre gamme de luminaires aux écrans de cannage vintage se teinte en noir et adopte un tressage carré, plus intemporel, faisant écho aux trames des paravents et au style architectural nippon. Tout en légèreté, avec de nouveaux effets de transparence, elle ne manquera pas de donner du caractère à tous vos intérieurs.

*Influenced by the ancestral Japanese technique of Yakisugi, consisting in burning the wood on the surface to protect it and make it last over time, this approach to durability gives a more graphic result than ever before. Our range of luminaires with vintage cane screens finds itself dyed black and adopts a more timeless square weave, echoing the weave of the screens and the Japanese architectural style. All in lightness, with new transparency effects that are sure to give character to your interiors.*





655542



56

656069



57

655627



655675



# SCREEN CANNAGE

Comme des jeux d'écrans qui lui donnent  
un air de mobile.

Jeux de matières et jeux de lumières.

Ces formes écrans aux look vintage s'adaptent  
à tous les styles décoratifs.

La cannage envahit nos intérieurs !

Matière chic et naturelle.

Elle inspire un art de vivre,  
un désir d'authenticité et de durabilité.

*Screens floating like a mobile. Light and material effect.*

*These vintage looking screens will suit any decorative style.*

*Chic and natural, caning is everywhere.*

*It inspires an art of living, a quest for authenticity and sustainability.*





651668



655173

60



655626



654194



655631

61



# SCREEN MURANO

La gamme Screen se pare de Murano.

Comme un mobile, ses écrans aux formes douces nous fascinent en jouant avec la lumière et la tamisent délicatement.

Le rendu lumineux de cette matière, évoquant le papier, accentue son impression de légèreté.

La pureté de son design en fait une gamme résolument intemporelle pour embellir tous les intérieurs.

*The Screen range is adorned with Murano.*

*Like a mobile, its softly shaped screens fascinate us  
by playing with light and gently dim it.*

*The luminous rendering of this material, reminiscent of paper,  
accentuates its impression of lightness.*

*The purity of its design makes it a resolutely timeless range  
that embellishes any interior.*







654555



652241



655625



656071



# SCREEN

Design  
MARKET SET

Suspension 1 lumière structure en métal peint, 2 écrans en cannage. Équipée d'une cordelière textile et d'un pavillon en métal adaptable DCL.

1-light pendant light with painted metal frame and 2 canework screens. Textile cord and metal canopy DCL adaptable included.

NEW

S

80230



E27 // 60W max.

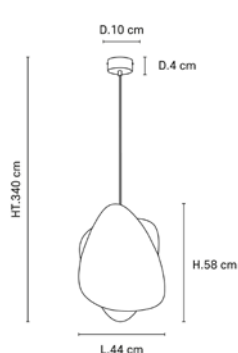

656070  
cannage naturel



656072  
cannage noir



656071  
blanc



66

Design  
MARKET SET

Suspension 1 lumière structure en métal peint, 2 écrans en cannage. Équipée d'une cordelière textile et d'un pavillon en métal adaptable DCL.

1-light pendant light with painted metal frame and 2 canework screens. Textile cord and metal canopy DCL adaptable included.

NEW

XS

80229



E27 // 60W max.

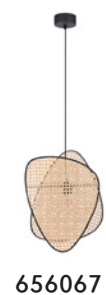
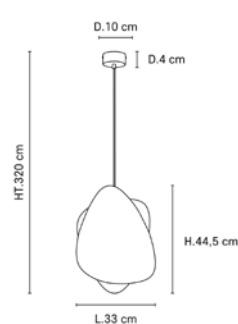

656067  
cannage naturel



656069  
cannage noir



656068  
blanc



67

Design  
MARKET SET

80145

Suspension XL esprit mobile. Structure en métal peint, 10 écrans en cannage bordés en tissu. Équipée d'une cordelière textile et d'un pavillon en métal adaptable DCL.

Mobile style pendant light. Painted metal frame and 10 canework screens with fabric edges. Textile cord and metal canopy DCL adaptable included. Large model.

80202

Suspension XXL esprit mobile. Structure en métal peint, 13 écrans en cannage bordés en tissu. Equipée de cordelières textiles et d'un pavillon en métal adaptable DCL.

Mobile style pendant light. Painted metal frame and 13 canework screens with fabric edges. Textiles cords included. and metal canopy.

80145



E27 // 60W max.



80202

4XE27 // 60W max.

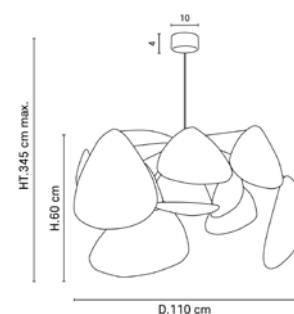

651668  
cannage

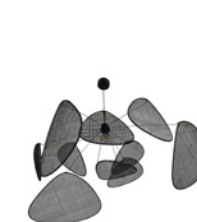

655542  
cannage noir



652241  
murano

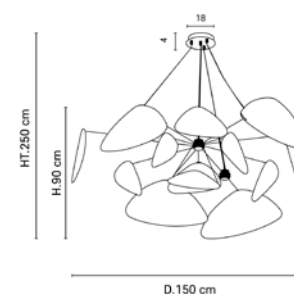

655173  
cannage



655543  
cannage noir



654554  
murano





# SCREEN

Design  
MARKET SET

Applique base en métal peint avec abat-jour composé de 1 écran en papier murano.  
*Painted metal base wall light and its murano paper screen with fabric edges lampshade.*

80203



E27 // 40W max.

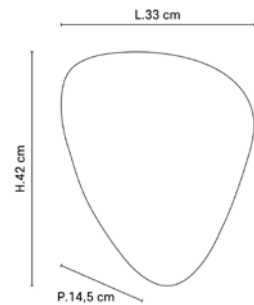

654194  
cannage



655544  
cannage noir



654555  
murano



68

Design  
MARKET SET

Applique 2 lumières base en métal peint avec abat-jour composé de 2 écrans en papier murano.  
*2-light painted metal base wall light and its 2 murano paper screens with fabric edges lampshades.*

80201



2XE27 // 40W max.

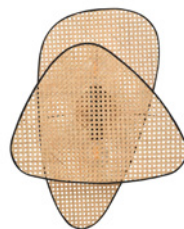
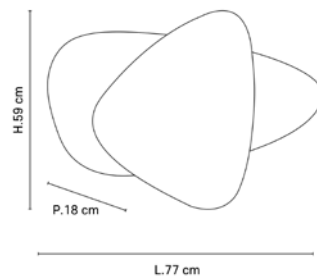

655172  
cannage



655545  
cannage noir



654556  
murano



Design  
MARKET SET

Lampe base en métal peint. Abat-jour composé de 2 écrans en cannage.  
*Painted metal base table lamp. 2 canework screens composed lampshade.*

80205



E27 // 40W max.

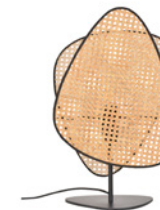
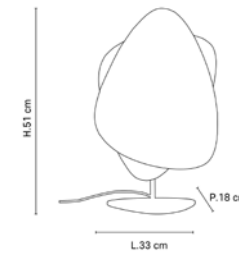

655626  
cannage

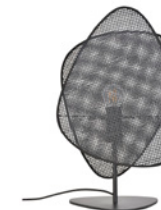

655627  
cannage noir



655625  
murano



69

Design  
MARKET SET

Lampadaire 3 lumières base en métal peint. Abat-jour composé de 5 écrans en papier murano.  
*3-light painted metal base table lamp. 5 murano paper composed lampshade.*

80206



3XE27 // 40W max.

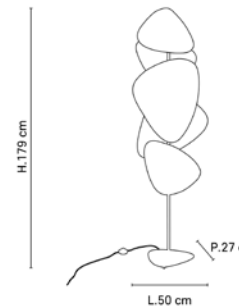

655631  
cannage



655675  
cannage noir



655632  
murano





## MKS X SONIA LAUDET

MARKET SET signe sa première collaboration avec Sonia Laudet, jeune et talentueuse Tapissier Designer. Une rencontre et une démarche d'éco-conception entre une marque créative et fabricante de luminaires bordelaise et une designer de la côte basque.

Formée sur les bancs des écoles de mode, puis de tapisserie d'ameublement, Sonia Laudet exprime dans son travail son amour des matières textiles et sa sensibilité écologique.

À la croisée du design et de l'artisanat d'art, sa démarche résolument contemporaine s'inscrit clairement dans la mouvance de la Slow Life. Que ce soit dans la mode ou la décoration d'intérieur, Sonia Laudet associe les chutes de textile, rythme les formes et les couleurs et évoque ses voyages où se mêlent lumières et paysages avec une singularité bien établie et un savoir-faire rigoureux et minutieux.

Ce projet est avant tout le partage de mêmes valeurs environnementales et sociales qui rendent cette collaboration si évidente. La récupération et la revalorisation des chutes de tissus sont au cœur du projet. Le résultat, poétique et délicat, est une ode à cette passion commune pour le textile.

A cet effet Market Set lance « MKS X SL ».

*MARKET SET signs its first collaboration with Sonia Laudet, a young and talented upholsterer designer. A creative and manufacturing lighting brand from the Bordeaux Region and a designer upholsterer from the Basque coast meet and gather around a common eco-design process.*

*Sonia Laudet graduated from Fashion Schools and completed her education with a degree in upholstery design. She expresses her love for textile materials and her ecological awareness through her work.*

*On the crossroads of design and craftwork, her resolutely contemporary approach is clearly in line with the Slow Movement. In fashion as in design, Sonia matches recycled textiles, brings rhythm to shapes and colors with a well-established singularity and a rigorous and meticulous know-how. Her artistic approach evokes her travels where lights and landscapes intertwine.*

*This project is above all sharing the same environmental and social values, which makes this collaboration self-evident. The recycling and recovery of scrap fabric lie at the heart of the project. The poetic and delicate result is an ode to the great passion Market Set and Sonia Laudet share for the textile.*

*Thus, Market Set launches "MKS X SL"*





# SONIA LAUDET

## MALACHITE

Elégante et sophistiquée, cette collection met en lumière les lignes subtiles du marbre ou de la malachite.

Le minéral est à l'honneur.

Les coloris les plus classiques sont ici revisités par des jeux de textures ton sur ton, demeurants chics et intemporels.

*Elegant and sophisticated, this collection highlights the subtle lines of marble or malachite.*

*The mineral is in the spotlight.*

*The most classic colours are revisited here by a play of tone-on-tone textures, remaining chic and timeless.*

PR503477







654530 - Ø60  
 654534 - Ø80  
 654542 - Ø40



654542 - Ø40  
 654546 - Ø60  
 654543 - Ø60



# SONIA LAUDET

## NOSTALGIA

A la croisée des mondes et des époques, la collection « Neo Nostalgia » nous transporte dans un univers poétique et feutré.

Les couleurs sont chaudes, les lignes rondes et les matières veloutées. On devine des fleurs.

Des fleurs sorties d'un rêve, des fleurs rapportées d'un lointain voyage.

*At the crossroads of worlds and periods, the «Neo Nostalgia» collection transports us into a poetic and muffled universe.*

*The colours are warm, the lines round and the fabrics velvety.  
We can distinguish flowers.*

*Flowers from a dream, flowers brought back from a distant journey.*





654552 - Ø60  
654551 - Ø40



654537 - Ø80  
654539 - Ø60





# SONIA LAUDET

Design  
MARKET SET

Lampadaire en métal peint finition sablée et détails laiton, forme trépied, orientable. Abat-jour conique bi-matière. Équipé d'un cordon textile et d'un interrupteur au pied.

Sand painted metal/brass finish tripod floor lamp. Bi-material conical lampshade. Textile cord and footswitch included.

80207



E27 // 15W max.

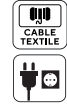

Ampoule conseillée  
Recommended bulb



G95  
654873

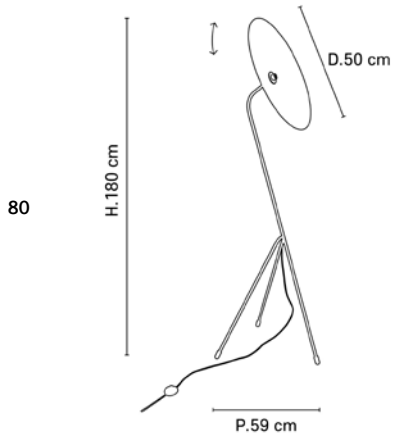

PR503477  
malachite nuit



PR503478  
malachite sable



PR503480  
nostalgia pivoine



PR503479  
nostalgia camélia

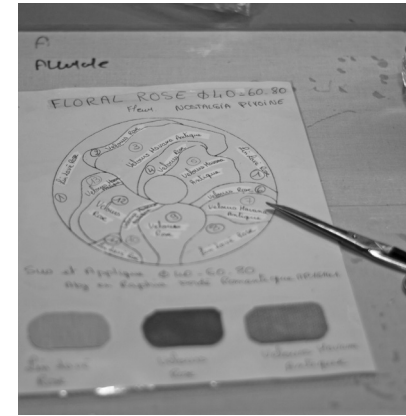



# SONIA LAUDET



E27 // 60W max.



CABLE  
TEXTILE



DCL



5585

Suspension 1 lumière. Équipée d'un cordon textile et d'un pavillon en métal peint adaptable DCL.

*Pendant light with textile cord and metal canopy DCL adaptable.*



82

	Ø60	Ø80
Malachite nuit	654530 	654531 
Malachite sable	654533 	654534 
Nostalgie camélia	654536 	654537 
Nostalgie pivoine	654539 	654540 



E27 // 60W max.



DCL



5586

Applique forme conique bi-matière. Equipée d'une patère murale en métal peint finition sablée et adaptable DCL.

*Bi-material conical wall light with painted metal/sand finish base.*



83

	Ø40	Ø60
Malachite nuit	654542 	654543 
Malachite sable	654545 	654546 
Nostalgie camélia	654548 	654549 
Nostalgie pivoine	654551 	654552 





# BALADEUSE SINGAPOUR

Intérieur ou extérieur, nous ressentons le besoin de nous approprier chaque espace de notre habitat dans l'intimité de notre décoration.

C'est pourquoi MARKET SET® enrichit l'une des gammes les plus emblématiques de sa collection, la SINGAPOUR, d'une baladeuse outdoor !

Gardant sa forme iconique de lanterne asiatique, la baladeuse en reprend tous les codes stylistiques. Du tissu coloré pour diffuser la lumière, du cannage pour évoquer l'artisanat et lui donner un look vintage, et des bordures en coton noir graphiques pour souligner ses formes.

Grâce à son abat-jour en tissu Sunbrella® déperlant, elle ne craint pas l'humidité et résiste aux UV pour garder sa belle couleur dans le temps.

Aussi belle dehors que dedans, la baladeuse SINGAPOUR possède une poignée en bambou pour nous accompagner dans tous les recoins de la maison, de la terrasse ou du jardin.

De belles soirées en perspectives...

*Indoors or outdoors, we feel the need to appropriate each space of our home in the intimacy of our decoration.*

*That is why MARKET SET® has added an outdoor portable lamp to one of the most emblematic ranges in its collection, the SINGAPOUR range!*

*Keeping its iconic Asian lantern shape, the outdoor portable lamp takes up all the stylistic codes of the Asian lantern. Coloured fabric to diffuse the light, canework to evoke craftsmanship and give it a vintage look, and graphic black cotton borders to highlight its shapes.*

*Thanks to its lampshade in water-repellent Sunbrella® fabric, it does not fear humidity and is UV-resistant in order to keep its beautiful colour over time.*

*As beautiful outside as inside, the outdoor portable SINGAPOUR lamp has a bamboo handle to accompany us in every corner of the house, terrace or garden.*

*Beautiful evenings ahead...*







655890  
655891  
655892



655890



655890  
655891  
655892



655890  
655891  
655892



655891



655891



# SINGAPOUR

Design  
MARKET SET

Baladeuse extérieur en polypropylène et poignée bambou. Abat-jour textile et cannage naturel amovible. Base LED rechargeable avec câble USB fourni. 3 températures de couleur, 2 intensités d'éclairage.

*Polypropylene outdoor hand lamp with bamboo handle. Textile shade and removable natural wickerwork. Rechargeable LED base with USB cable included. 3 colour temperatures, 2 lighting intensities.*

80215

LED  
intégrée

4W max.

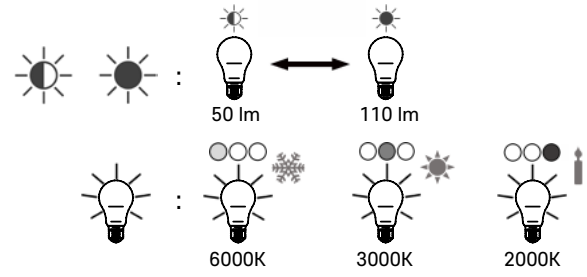
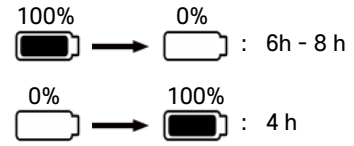

HT.32,5 CM



D.21,5 CM



655891  
algae



3 188000 772831



655890  
honey



3 188000 772824



655892  
sand



3 188000 772848

655890  
655891  
655892





# SINGAPOUR FÉMININ

La gamme SINGAPOUR propose de véritables éléments graphiques pour la décoration intérieure. Les effets de lumière du cannage naturel et du lin lavé, ainsi que les bordures contrastées créent tout un univers poétique autour de ces luminaires inspirés des lanternes traditionnelles asiatiques, revisités et fabriqués dans nos ateliers.

Cette année, les coloris s'harmonisent par gammes.

La gamme Féminine a des couleurs très douces : les pastels, comme l'amande et le rose apportent de la fraîcheur.

Les bordures en coton noir, très graphiques et modernes, soulignent ses formes géométriques en apportant une touche de chic.

*The SINGAPORE range offers real graphic elements for interior design. The light effects of natural canework and washed linen, as well as the contrasting borders create a whole poetic universe around these lights inspired by traditional Asian lanterns, revisited and manufactured in our workshops.*

*This year, the colours are harmonized by ranges.*

*The Women's range has very soft colours: pastels such as almond and pink which bring a touch of freshness.*

*The black cotton borders, very graphic and modern, underline its geometrical shapes by bringing a touch of chic.*









# SINGAPOUR MASCULIN

La gamme SINGAPOUR s'inspire des lanternes asiatiques traditionnelles, pour apporter une touche originale et nostalgique à la décoration. Ses jeux de superpositions d'abat-jour, fabriqués dans nos ateliers en matières naturelles et durables comme le lin lavé et le cannage, en font une gamme inspirante qui invite au mix & match des couleurs.

Cette année, les coloris s'harmonisent par gammes.

La gamme Masculine est contrastée : les coloris blancs, épice et curry illuminent les couleurs sombres et plus sobres comme le kaki, l'antracite et les bordures noires, très graphiques.

Le mix a du caractère, et affirme son style vintage !

*The SINGAPORE range is inspired by traditional Asian lanterns, to bring an original and nostalgic touch to decoration. Its lampshade layering combinations, made in our workshops in natural and durable materials such as washed linen and canework, make it an inspiring range that invites you to mix & match colours.*

*This year, the colours are harmonized by ranges.*

*The Masculine range is contrasted: white, spice and curry colours light up the darker and more sober colours such as khaki, anthracite and the very graphic black borders.*

*The mix has character and asserts its vintage style!*

PR503871









# SINGAPOUR NUDE

Continuellement en quête de douceur, la gamme SINGAPOUR, dont les formes nous évoquent des lampions asiatiques, revêt de nouveaux tissus pour un véritable retour aux sources. La toile de jute naturelle, traditionnelle et rassurante, contraste avec un tissu aux vertus dépolluantes à base de lin. Le mix avec le cannage en font une gamme remplie d'émotions et de sensibilité, aux effets lumineux extraordinaires et aux lignes graphiques.

*Continually in pursuit of softness, the SINGAPORE range, whose shapes remind us of Asian lanterns, takes on new fabrics for a true return to its roots. The natural, traditional and reassuring hessian contrasts with a linen-based fabric with depolluting virtues. The mix with cane makes it a range full of emotions and sensitivity, with extraordinary light effects and graphic lines.*





PR503481



655553



PR503483



100

PR503482



101





# SINGAPOUR

Design  
MARKET SET



E27 // 60W max.



## 5563 SUSPENSION - S

## 5576 SUSPENSION - XS

Suspension empilement de 3 abat-jour en lin lavé et cannage. Équipée d'un cordon textile et d'un pavillon en métal adaptable DCL.

*Pendant light made of 3 piled washed linen and canework shades. Textile cord and metal canopy DCL adaptable included.*

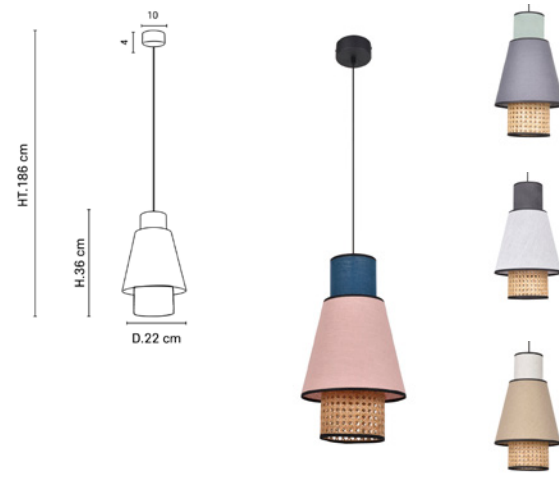

102

Rose/Pétrole  
Pink/Petrol 652153  
3 188000 737892

653647  
3 188000 752703

Blanc/Anthracite  
White/Anthracite 652198  
3 188000 738752

653644  
3 188000 752680

Anthracite/Amande  
Anthracite/Almond 655922  
3 188000 773067

653645  
3 188000 752734

Nude  
Nude 655546  
3 188000 770271

655549  
3 188000 770301



Design  
MARKET SET



E27 // 60W max.



## 5565 SUSPENSION - M

## 5577 SUSPENSION - XM

Suspension empilement de 3 abat-jour en lin lavé et cannage. Équipée d'un cordon textile et d'un pavillon en métal adaptable DCL.

*Pendant light made of 3 piled washed linen and canework shades. Textile cord and metal canopy DCL adaptable included.*



Nude  
Nude 655548  
3 188000 770295

655550  
3 188000 770318

Anthracite/Blanc  
Anthracite White 652196  
3 188000 738738

653651  
3 188000 752758

Gris clair/Épices  
Light grey/Spices 653035  
3 188000 747693

653650  
3 188000 752741

Amande/Anthracite  
Almond/Anthracite 655921  
3 188000 773050

655920  
3 188000 773043

103





# SINGAPOUR

Design  
MARKET SET



E27 // 60W max.



## 5564 SUSPENSION - ML

## 5578 SUSPENSION - XML

Suspension empilement de 4 abat-jour en lin et cannage. Equipée d'un cordon textile et d'un pavillon métall adaptable DCL.

*Pendant light, stacking of 4 washed linen and canework lampshades. Delivered with textile electrical cord and metal canopy.*

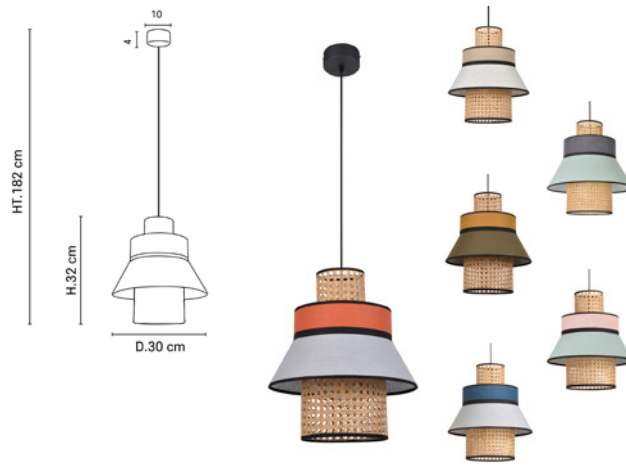

104

Gris clair/Épices  
Light grey/Spices 655917

655916

Nude  
Nude 655547

655551

Gris clair/Pétrole  
Light grey/Petrol 655918

653654

Amande/Anthracite  
Almond/Anthracite 652201

653655

Kaki/Curry  
Khaki/Curry 653034

653652

Amande/Rose  
Almond/Pink 652152

653657

Ampoule conseillée  
Recommended bulb  
 A60  
654313

Design  
MARKET SET



E27 // 60W max.  
3XE27 // 60W max.



## 5617 SUSPENSION - XL

## 5571 SUSPENSION - XXL

Suspension XL empilement de 3 abat-jour en lin lavé et cannage. Equipée d'un cordon textile et d'un pavillon en métal adaptable DCL.

*XL pendant light, stacking of 3 washed linen and canework lampshade. Delivered with textile electrical cord and metal canopy.*

Suspension XXL empilement de 3 abat-jour en lin lavé et cannage. Equipée d'un cordon textile et d'un pavillon en métal adaptable DCL.

*Pendant light made of 3 piled washed linen and canework shades. Textile cord and metal canopy DCL adaptable included. XXL model.*



Nude  
Nude 655912

655552

Kaki/Blanc  
Khaki/White 655914

653084

Gris clair/Anthracite  
Light grey/Anthracite 655915

653086

Gris clair/Épices  
Light grey/Spices 655913

655919

105

Ampoule conseillée  
Recommended bulb  
 G95  
654873



# SINGAPOUR

Design  
MARKET SET



E27 // 40W max.



## 80182 LAMPE

## 80183 LAMPE

Lampe en métal peint finition sablée. Abat-jour en lin lavé et cannage. Équipée d'un cover amovible sur le haut de l'abat-jour, d'un cordon textile et d'un interrupteur.

*Painted metal/sand finish table lamp. Washed linen and canework lampshade. Removable cover on top, textile cord and switch included.*

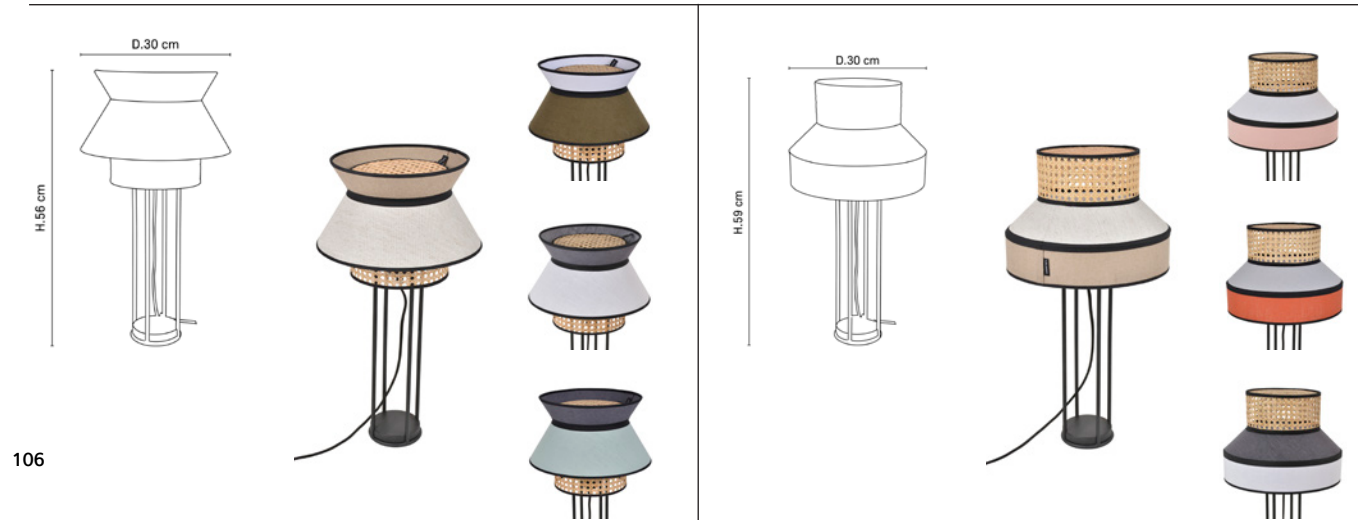

Nude  
Nude  
PR503482  
3 188000 770608

Nude  
Nude  
PR503481  
3 188000 770592

Kaki/Blanc  
Khaki/White  
PR503870  
3 188000 773210

Rose/Blanc  
Pink/White  
PR503455  
3 188000 748478

Blanc/Anthracite  
White/Anthracite  
PR503448  
3 188000 748409

Épices/Gris clair  
Spices/Light grey  
PR503454  
3 188000 748461

Amande/Anthracite  
Almond/Anthracite  
PR503869  
3 188000 773074

Blanc/Anthracite  
White/Anthracite  
PR503453  
3 188000 748454



Design  
MARKET SET



E27 // 40W max.



## 80184 LAMPADAIRE

## 80185 LAMPADAIRE

Lampadaire en métal peint finition sablée. Abat-jour en lin lavé et cannage. Équipé d'un cordon textile et interrupteur au pied.

*Painted metal/sand finish floor lamp. Washed linen and canework lampshade. Textile cord and footswitch included.*

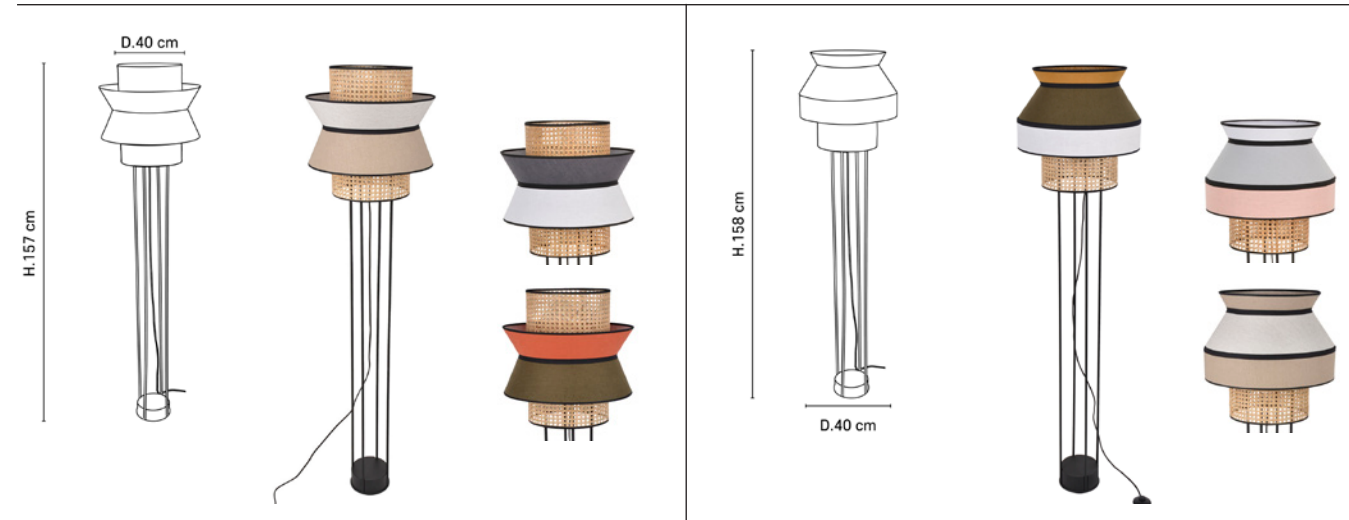

Nude  
Nude  
PR503483  
3 188000 770615

Blanc/Kaki/Curry  
White/Khaki/Curry  
PR503871  
3 188000 773104

Blanc/Anthracite  
White/Anthracite  
PR503444  
3 188000 748348

Rose/Gris clair/Blanc  
Pink/Light grey/White  
PR503449  
3 188000 748416

Kaki/Épices  
Khaki/Spices  
PR503441  
3 188000 748300

Nude  
Nude  
PR503484  
3 188000 770622





# SINGAPOUR

Design  
MARKET SET



E27 // 60W max.



80188

Applique forme conique, empilement de 3 abat-jour en lin lavé et cannage. Équipée d'une base ronde en métal peint adaptable DCL.  
Conical wall light made of 3 piled washed linen and canework shades. Round painted metal base DCL adaptable included.

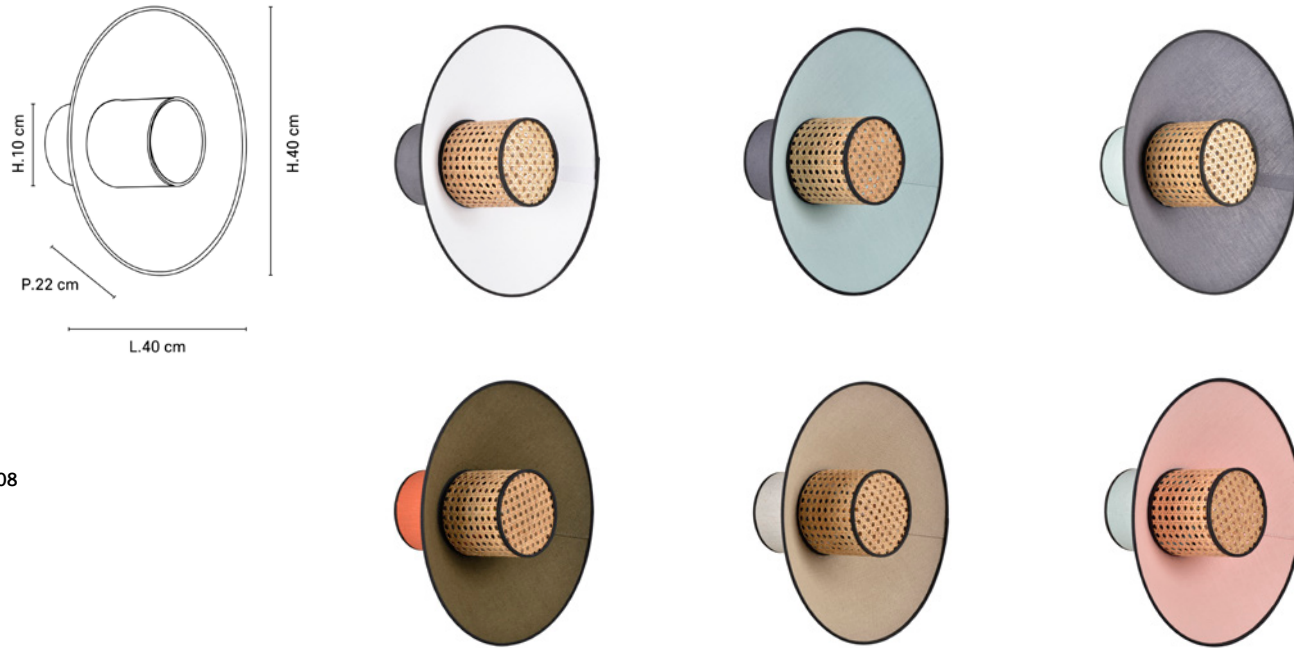

108

Anthracite/Blanc  
Anthracite/White 653072  
3 188000 748492

Nude  
Nude 655553  
3 188000 770349

Anthracite/Amande  
Anthracite/Almond 655927  
3 188000 773135

Amande/Rose  
Almond/Pink 655926  
3 188000 773128

Amande/Anthracite  
Almond/Anthracite 653075  
3 188000 748522

Épices/Kaki  
Spices/Khaki 653076  
3 188000 748539



Design  
MARKET SET

Boîte en lin lavé et cannage.  
Washed linen and canework box.



5587 - S	5588 - M	5589 - L	5596 - SET DE 3
H. 13 CM Ø14 CM	H. 16,5 CM Ø19 CM	H. 20 CM Ø26 CM	H. 13 CM Ø14 CM H. 16,5 CM Ø19 CM H. 20 CM Ø26 CM
Rose Pétrole 654561 3 188000 762214	Anthracite Amande 654563 3 188000 762238	Pétrole Rose 654566 3 188000 762269	655236 3 188000 765666
Pétrole Curry 654562 3 188000 762221	Kaki Épices 654564 3 188000 762245	Curry Pétrole 654565 3 188000 762252	655237 3 188000 765673

109

Design  
MARKET SET

Suspension 3 lumières avec abat-jour en lin lavé et cannage. Equipée de cordelières textiles et d'une règlette en métal assorti.  
3-light bar pendant light with 3 washed linen and canework lampshade. Matching métal ceiling plate and textile cords.

XS

80030



3XE27 // 40W max.

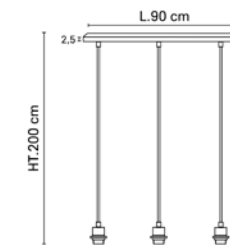

655947  
blanc/anthracite



655948  
nude





# SINGAPOUR

Design  
MARKET SET

Suspension 3 lumières avec 3 abat-jour en lin lavé et cannage. Equipée de cordons textiles, d'accroches métal pour le passage du cordon et d'un pavillon en métal rond assorti.

3-light bar pendant light with 3 washed linen and canework lampshade. Metal hooks to cord passage and matching round metal canopy and textile cords.

80193



3XE27 // 40W max.

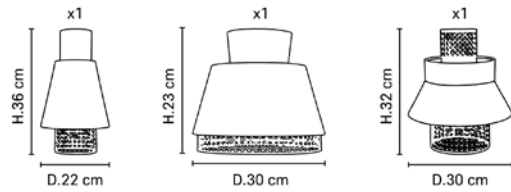
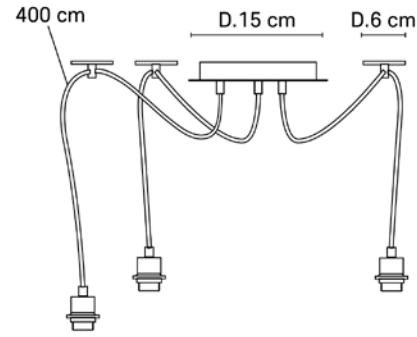

655951  
nude



Design  
MARKET SET

Suspension 5 lumières avec 5 abat-jour en lin lavé et cannage. Equipée de cordons textiles, d'accroches métal pour le passage du cordon et d'un pavillon en métal rond assorti.

5-light bar pendant light with 5 washed linen and canework lampshade. Metal hooks to cord passage and matching round metal canopy and textile cords.

80194



5XE27 // 40W max.

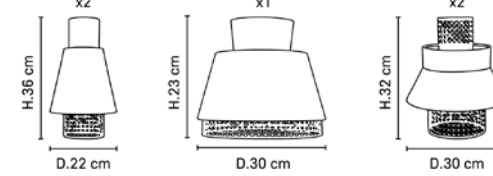
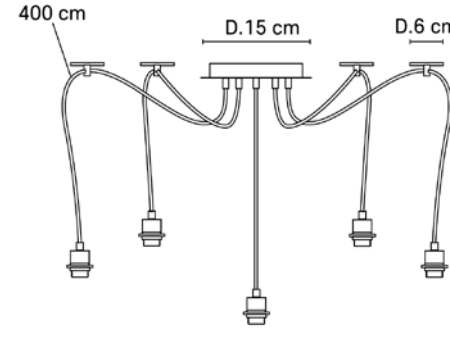

655954  
nude



655950  
masculin



655949  
féminin



655953  
masculin



655952  
féminin





# MEKKO

Esprits libres et modernes.  
Virevoltez au rythme de ces crinolines en bambou naturel.  
Nuances pasteltes et matières chaleureuses.  
Design géométrique scandinave.

*Modern and free spirits.  
Spin around these natural bamboo crinolines in rhythm.  
Pastel shades and warm materials.  
Geometric scandinavian design.*

653639  
653641



113

112



654191 - S



653640 - M  
653642 - L  
653638 - S



115

114

654192 - S

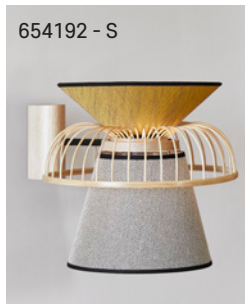

654190 - S





# MEKKO

Design  
MARKET SET

Suspension empilement de 2 abat-jour en tissu matière dépolluante composée de lin et d'une couronne en bambou. Équipée d'un cordon textile et d'un pavillon métal adaptable DCL.

*Pendant light made of 2 piled air-purifying texture linen shades and a bamboo crown on top. Textile cord and metal canopy DCL adaptable included.*

S

5573



E27 // 60W max.

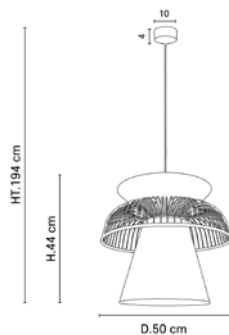

653638  
blanc/rose



653637  
bleu ciel/blanc



Design  
MARKET SET

Suspension empilement de 2 abat-jour en tissu matière dépolluante composée de lin et d'une couronne en bambou. Équipée d'un cordon textile et d'un pavillon métal adaptable DCL.

*Pendant light made of 2 piled air-purifying texture linen shades and a bamboo crown on top. Textile cord and metal canopy DCL adaptable included.*

L

5575



E27 // 60W max.

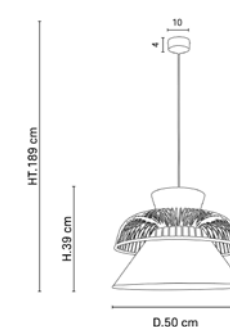

653642  
bleu ciel/riad



653641  
blanc/jaune



116

Design  
MARKET SET

Suspension empilement de 2 abat-jour en tissu matière dépolluante composée de lin et d'une couronne en bambou. Équipée d'un cordon textile et d'un pavillon métal adaptable DCL.

*Pendant light made of 2 piled air-purifying texture linen shades and a bamboo crown on top. Textile cord and metal canopy DCL adaptable included.*

M

5574



E27 // 60W max.

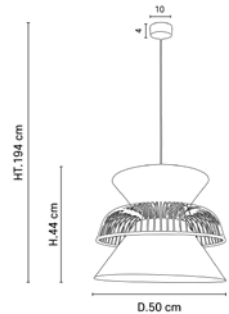

653640  
riad/jaune



653639  
rose/riad



117

Design  
MARKET SET

Applique base en métal peint et bois. Composée d'un empilement de 2 abat-jour matière dépolluante et d'une couronne en bambou naturel.

*Wall light made of 2 piled air-purifying texture linen shades and a bamboo crown on top. Painted metal and wood base.*

S

5584



E27 // 40W max.

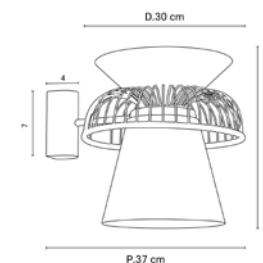

654192  
riad/jaune



654190  
bleu ciel/blanc



654191  
blanc/rose





# GATSBY

Gatsby revient habillé de velours.  
Élégant, précieux, le style art Déco nous séduit toujours.

Revisité dans les coloris tendance de la saison.

On lui redécouvre un style rétro décliné  
sur des coloris profonds et masculins.

Velours cognac, velours émeraude, velours glacier.

Tissus riches aux teintes profondes.

*Gatsby comes back dressed in velvet.*

*Elegant and precious, Art Deco is always seductive.*

*Revisited with the new season trendy colors.*

*We rediscover its retro style with a new palette of deep and masculine colors.*

*Cognac, emerald and ice-blue velvet. Rich Fabric with deep shades.*





PR590298 - Ø50  
PR590300 - Ø60  
PR590296 - Ø40



PR590309





# GATSBY

Libérez le style Art Déco.  
Motifs, matières éclatantes, mix & match.  
Excès de chic!

*Free the Art Deco style.  
Patterns, striking materials, mix and match.  
Chic overload!*

122

PR590261



123



PR590230 - 2L  
PR590261



124



PR590210



125





# GATSBY

Notre gamme iconique GATSBY, au style art déco, si chic et décomplexé, se renouvelle ! Toujours dans la continuité de cette Collection, l'influence du style nippon en décoration se fait ici avec un tissu en jacquard satiné et aux motifs très graphiques, inspirés des paysages des estampes japonaises.

Proposée en deux teintes sombres et masculines très tendances, avec un noir et un kaki, cette gamme permet d'apporter un élément graphique, sculptural et affirmé à la décoration. Le dessin des nuages, Kumo en japonais, est traité dans un style presque calligraphique, et prend ici des allures de gravures, de fresques.

*Our iconic GATSBY Collection, with Art deco style, so chic and no complex, renews ! Always in the continuity of the Collection, The influence of the nippon style decoration is made of satin jacquard fabric with graphics patterns, inspired from japaneses landscapes prints.*

*Provided in two dark and male trendy teints, with black and khaki, this Collection could bring a graphic element, sculptural and affirmed to the decoration. The clouds drawing, Kumo in japanese, is treated in a nearly calligraphic style, and has engravings, murals aspects.*

PR503502





PR503507



655737



656084

128



PR503511

129



# GATSBY

Design  
MARKET SET



E27 // 60W max.



5010

Suspension conique double coupe. Extérieur en coton et intérieur en matière. Équipée d'un cover en métal filaire, d'un cordon textile et d'un pavillon en métal sablé adaptable DCL.

*Dual cut conical pendant light. Cotton on the outside and material inner. Metal wire cover, textile cord and sanded metal canopy DCL adaptable included.*



130

Paon noir 652192 

Kumo kaki 656081  **NEW**

Trésor mercure 652194 

Kumo noir 655737  **NEW**



Design  
MARKET SET



2XE27 // 40W max.



80180

Plafonnier 2 lumières en métal peint finition sablée et détails laiton. Composé de 2 bras pivotants et caches douilles en métal. Vendu avec 2 abat-jour coniques Ø40 bi-matière. Hauteur ajustable. Pavillon adaptable DCL.

*Brass finish and sand painted metal 2-light ceiling light. 2 articulated arms and metal sockets. Sold with bi-material conical Ø40 shade. Adjustable height. Canopy DCL adaptable.*



131

Paon noir 655956 

Kumo kaki 656082  **NEW**

Trésor mercure 655957 

Kumo noir 656083  **NEW**





# GATSBY

Design  
MARKET SET

Plafonnier 5 lumières en métal peint finition sablée et détails laiton. Composé de 5 bras articulés et caches douilles en métal. Equipé de cordelières textiles et d'un pavillon en métal peint adaptable DCL et de 5 abat-jour forme conique en velours.

5 lights metal ceiling light. Sand et brass details finish. Delivered with 5 different colors and diameters shades. With 5 articulated arms, metal sockets and a metal canopy adaptable DCL. Color : multicolor.

80181



5XE27 // 40W max.



Ampoule conseillée  
Recommended bulb

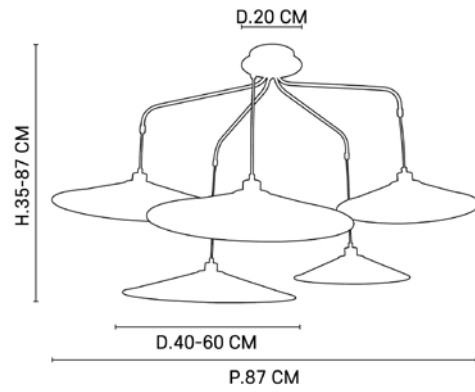

656084  
multicolore



132



655931  
velours



655932  
paon noir



Design  
MARKET SET



E27 // 40W max.



80094

Applique déportée base rectangle. Bras pivotant, finition sablée détails laiton. Équipée d'un abat-jour conique bi-matière. Cache douille et douille orientable.

Adjustable wall light bracket, rectangular base. Swing arm, sand and brass finish. Bi-material conical lampshade. Swivelling socket and cover included.



133



Paon noir

PR590210



Kumo khaki

PR503511



NEW



Trésor mercure

PR590213



Kumo noir

PR503512



NEW

Ampoule conseillée  
Recommended bulb



3 188000 760166



# GATSBY



E27 // 60W max.



DCL



5012

Applique forme conique bi-matière. Équipée d'une patère murale en métal peint finition sablée et adaptable DCL.  
*Bi-material conical wall light. With a painted metal/sand finish wall base and DCL adaptable included.*

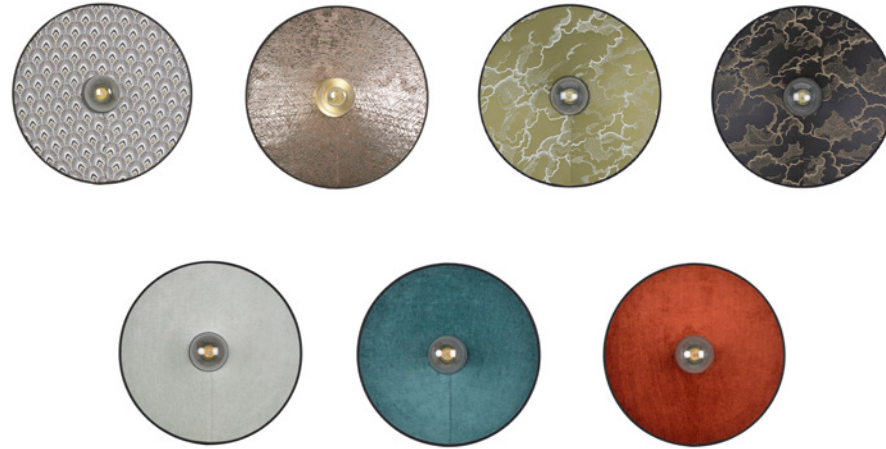
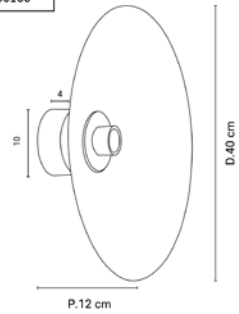

134

	Ø40	Ø50	Ø60
Paon noir	PR590186 3 188000 738943	PR590191 3 188000 738998	PR590196 3 188000 739049
Trésor mercure	PR590184 3 188000 738929	PR590189 3 188000 738974	PR590194 3 188000 739025
Kumo kaki <b>NEW</b>	PR503501 3 188000 774477	PR503503 3 188000 774491	PR503505 3 188000 774514
Kumo noir <b>NEW</b>	PR503502 3 188000 774484	PR503504 3 188000 774507	PR503506 3 188000 774521
Glacier	PR590296 3 188000 758545	PR590299 3 188000 758576	PR590302 3 188000 758606
Emeraude	PR590295 3 188000 758538	PR590298 3 188000 758569	PR590301 3 188000 758590
Cognac	PR590294 3 188000 758521	PR590297 3 188000 758552	PR590300 3 188000 758583



E27 // 40W max.



CABLE TEXTILE



80187

Lampe base ronde en métal peint finition sablée et détails laiton. Abat-jour conique bi-matière. Equipée d'un cordon textile et d'un interrupteur.  
*Sand painted metal/brass finish table lamp, round base. Bi-material conical lampshade. Textile cord and switch included.*

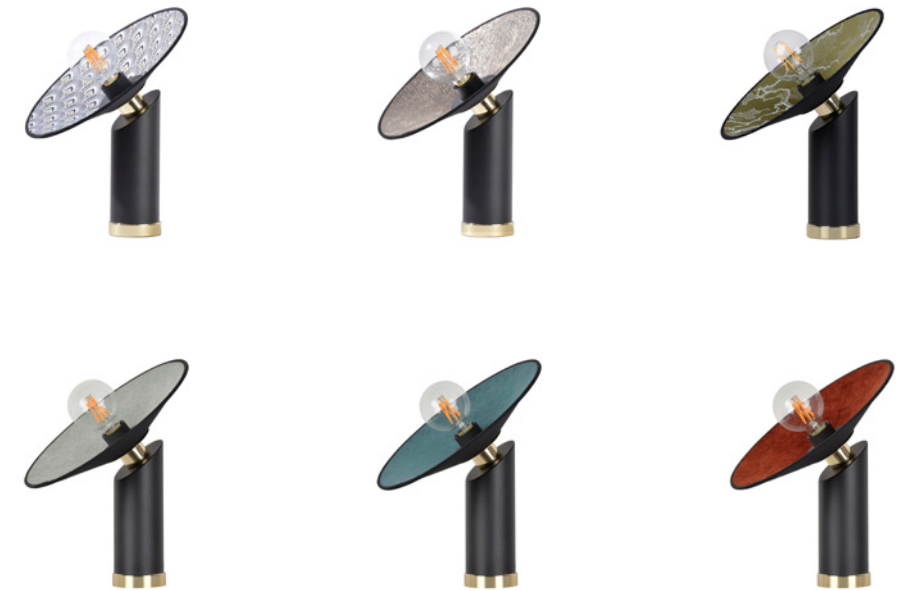
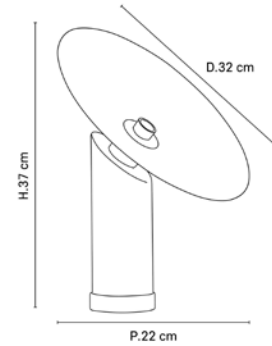

135

Paon noir	PR590261 3 188000 748263	Glacier	PR590305 3 188000 758675
Trésor mercure	PR590266 3 188000 748355	Emeraude	PR590304 3 188000 758668
Kumo kaki <b>NEW</b>	PR503507 3 188000 774538	Cognac	PR590303 3 188000 758651
Kumo noir <b>NEW</b>	PR503508 3 188000 774545		





# GATSBY

Design  
MARKET SET



E27 // 15W max.



80093

Lampadaire en métal peint finition sablée et détails laiton, forme trépied, orientable. Abat-jour conique bi-matière. Équipé d'un cordon textile et d'un interrupteur au pied.

Brass finition and sand painted metal tripod floor lamp. Two materials conical shade. Delivered with textile cord and foot switch.



136

 Paon Noir PR590207 

 Trésor Mercure PR590209 

 Kumo kaki **NEW** PR503509 

 Kumo noir **NEW** PR503510 

 Glacier PR590308 

 Emeraude PR590307 

 Cognac PR590306 



PR503510



137



# LORD

Affirmez votre style!  
Mixez l'indus et le chic.  
Un cocktail à consommer  
sans modération.

*Affirm your style.  
Mix industrial style and chic.  
A cocktail to consume  
without moderation*



651092

650901



139

138



# LORD

## 80005

Suspension style industriel forme cloche en verre transparent. Équipée d'une cordelière textile et d'un pavillon en métal peint. Douille et finition laiton.

*Metal industrial style pendant light with a bell shaped clear glass lampshades. Metal socket and screws, brass finish. Textile cord and painted metal canopy included.*

## 80006

Suspension 3 lumières style industriel. Abat-jour cloches en verre transparent. Équipée d'une réglette en métal peint. Douilles et finition laiton.

*Metal industrial style 3-light pendant light with bell shaped clear glass lampshades. Metal ceiling sealing. Metal socket and screws, brass finish.*

80005



E27 // 40W max.



80006

3XE27 // 40W max.

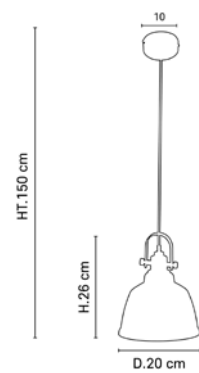

80005 - 650901  
laiton/noir mat

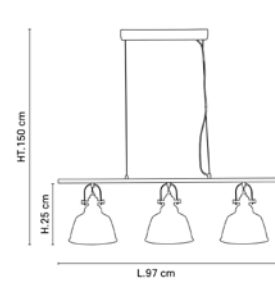

80006 - 650900  
laiton/noir mat



Applique style industriel, base en métal peint. Abat-jour cloche en verre transparent. Tête pivotante.

*Metal industrial style wall light, with an up and down movable clear glass shade.*

80004



E27 // 40W max.

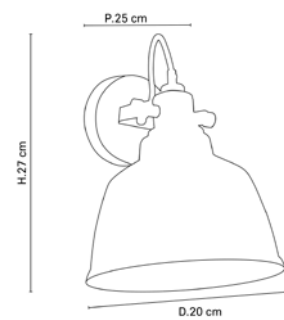

650902  
laiton/noir mat



Lampadaire style industriel en métal, abat-jour en verre transparent orientable finition laiton. Pied en métal peint, douille et visserie métalliques.

*Industrial style floor lamp in brass and matt black metal. Up and down directional head with clear glass bell shade. Metal socket and screws.*

80016



E27 // 40W max.

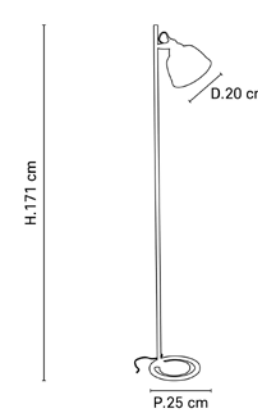

651092  
Laiton/Noir Mat



Lampe style industriel en métal, abat-jour en verre transparent orientable finition laiton. Pied en métal peint, douille et visserie métalliques.

*Industrial style table lamp in brass and matt black metal. Up and down directional head with clear glass bell shade. Metal socket and screws.*

80007



E27 // 40W max.

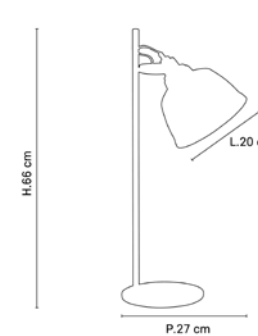

651091  
Laiton/Noir Mat





Lampe en céramique brillante, entretoise et cache douille en métal. Abat-jour cylindre en bana.  
 Shiny ceramic lamp, metal pipe and socket. Bana cylinder lampshade.

Lampe bi-matière en bois et laiton brossé brillant. Abat-jour cylindre en bana.  
 Two material wood and shiny brass brush table lamp, bana cylinder lampshade.

80148



E27 // 60W max.



80136



E27 // 40W max.



# IMPERIAL

IMPERIAL évoque les motifs des vases et de la vaisselle asiatique avec ses taches d'encres, comme de la calligraphie.

*IMPÉRIAL evokes the motifs of Asian vases and crockery with its ink stains, like calligraphy.*

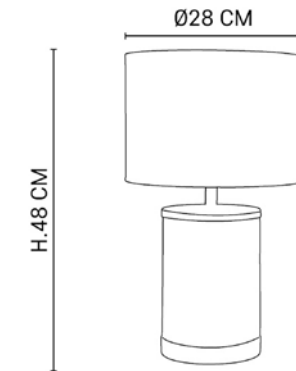
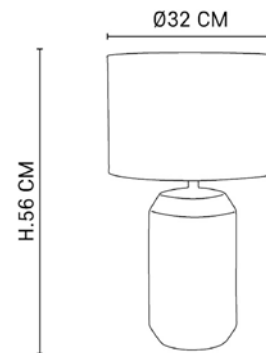

PR503873



PR503873  
indigo/bana



# PRÉCIEUX

PRÉCIEUX rappelle le style des années 50 avec ses finitions laiton et bois foncé.

*PRECIOUS remember the style of the 50s with its brass and dark wood finishes.*



PR503872  
laiton/bana





651649



# SPY

La lumière est partout!  
Un ciel éclatant répondant à tous vos désirs.

*Light is everywhere!  
A brilliant sky answering all your desires.*

# WATERLILY

Lignes graphiques entre ombre et lumière.  
Élégant mystère.

*Graphic lines between shadow and light.  
Elegant mystery.*

PR590223





# SPY

Design  
MARKET SET

80142

Suspension en métal 1 lumière. Équipée d'un cordon textile, d'une accroche métal pour le passage du cordon et d'un pavillon en métal assorti.

1-light metal pendant light. Textile cord, metal hook to hold the cord and match metal canopy included.

80143

Suspension en métal 5 lumières. Équipée d'un cordon textile, d'accroches métal pour le passage du cordon et d'un pavillon en métal assorti.

5-light metal pendant light. Textile cord, metal hooks to hold the cord and match metal canopy included.



80142



E27 // 40W max.



80143

5XE27 // 60W max.

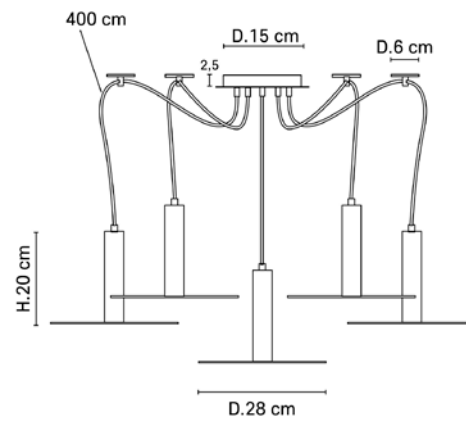
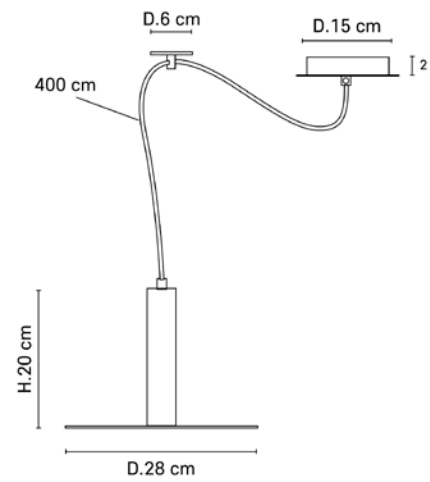

80142 - 651650

laiton



80143 - 651649

laiton



# WATERLILY

Design  
MARKET SET

80125

Suspension ajourée en métal. Équipée d'un cordon textile et d'un pavillon en métal adaptable DCL.

Openwork metal pendant light. Delivered with textile electrical cord and metal canopy.

80126

Applique ajourée en métal. Équipée d'une patère murale en métal adaptable DCL.

Openwork metal wall light. Delivered with base wall in metal.

80130

Lampadaire en métal peint finition sablée et détails laiton, forme trépied, orientable. Abat-jour ajouré en métal.

Brass finition and sand painted metal tripod floor lamp. Openwork metal lampshade.



E27 // 60W max.

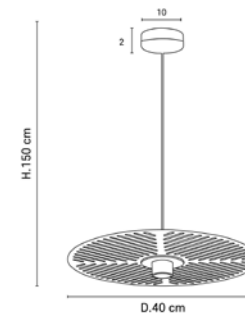

651906

Laiton



651907

Noir

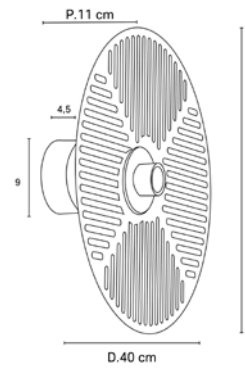

651908

Laiton



651931

Noir



E27 // 15W max.

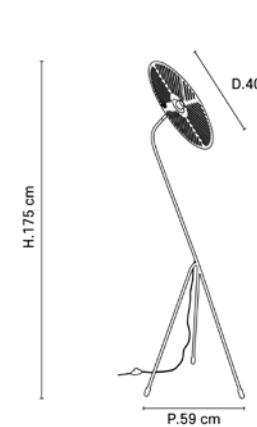

PR590223

Laiton



PR590222

Noir





PENDANT LIGHTS 1L **SUSPENSIONS 1L**

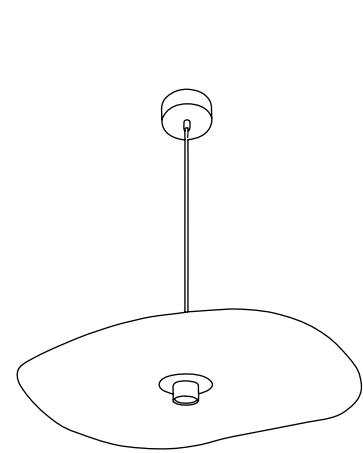

80219 RIVAGE  
P.11

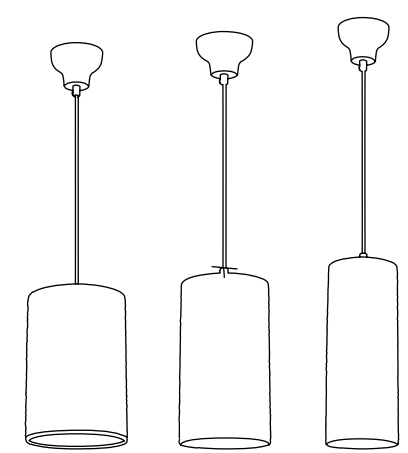

5618 COSINESS  
P.16

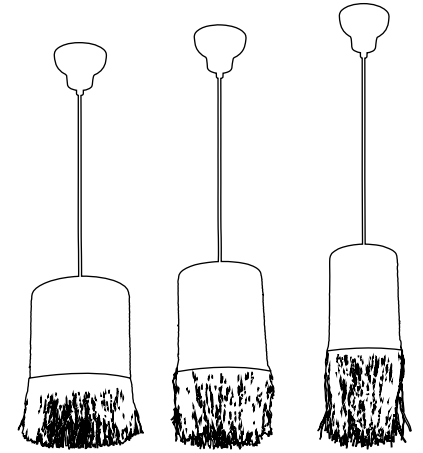

5616 FORMENTERA  
P.26

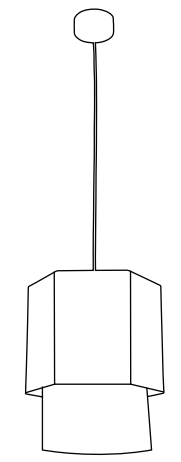

5613 MARRAKECH  
P.44

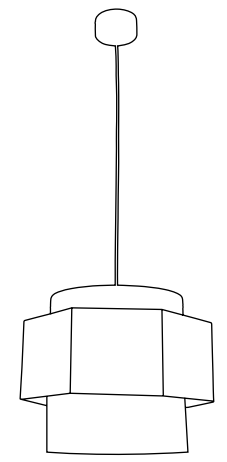

5614 MARRAKECH  
P.45

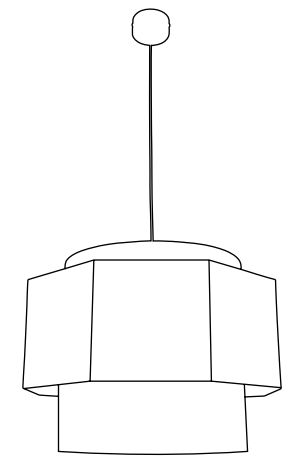

5615 MARRAKECH  
P.45

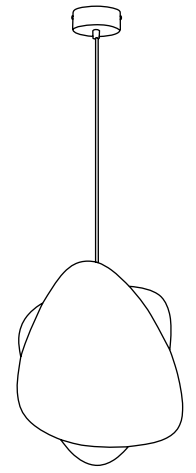

80230 SCREEN  
P.66

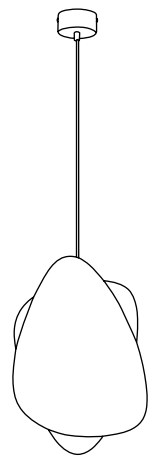

80229 SCREEN  
P.66

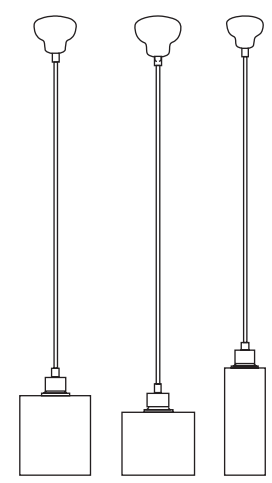

80029 ILO-ILO  
P.30

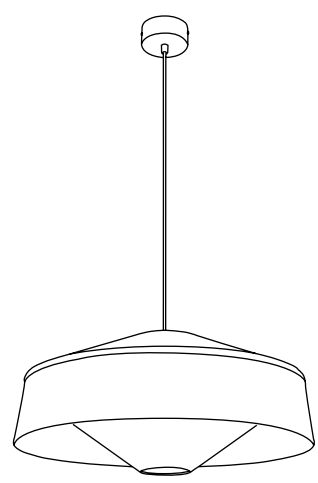

80221 MOKUZAĪ  
P.36

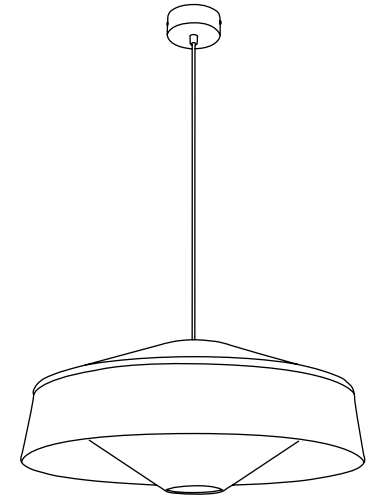

80222 MOKUZAĪ  
P.36

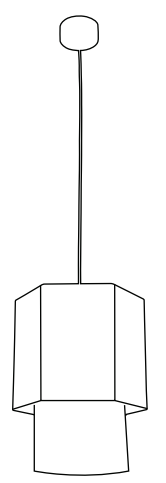

5612 MARRAKECH  
P.44

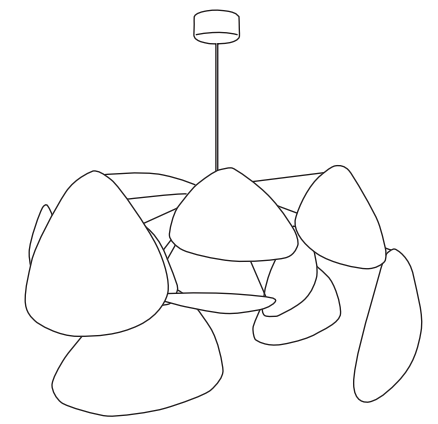

80145 SCREEN  
P.67

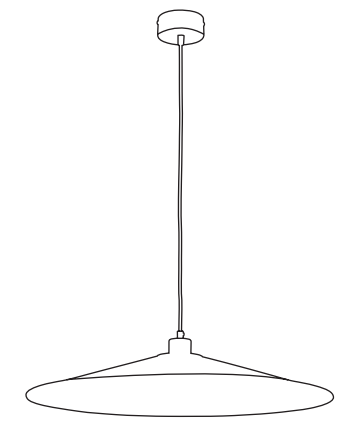

5585 SONIA LAUDET  
P.82

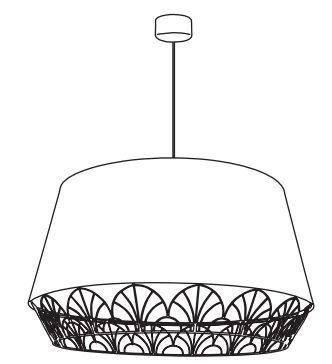

5010 GATSBY  
P.130

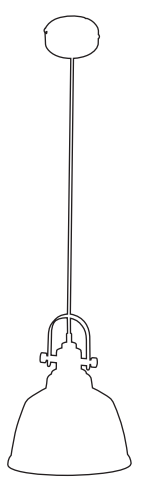

80005 LORD  
P.140



PENDANT LIGHTS 1L **SUSPENSIONS 1L**

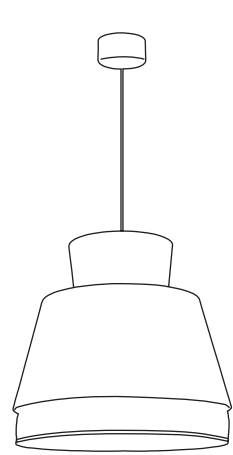

5565 SINGAPOUR  
P.103

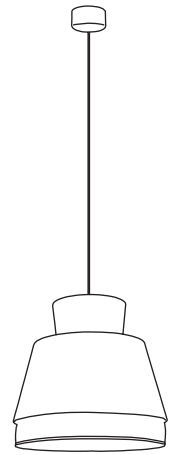

5577 SINGAPOUR  
P.103

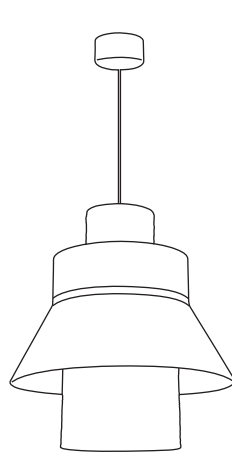

5564 SINGAPOUR  
P.104

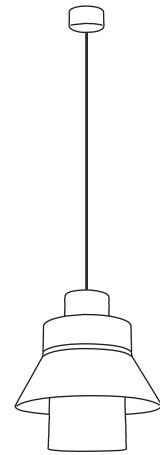

5578 SINGAPOUR  
P.104

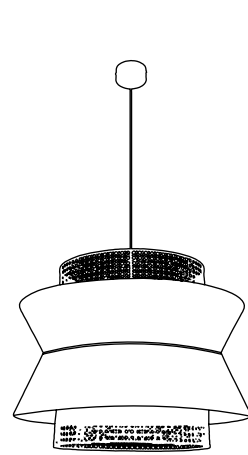

5617 SINGAPOUR  
P.105

PENDANT LIGHTS 1L **SUSPENSIONS 1L**

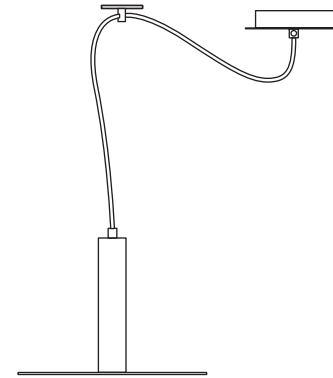

80142 SPY  
P.146

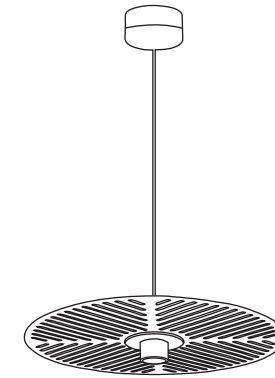

80125 WATERLILY  
P.147

150

PENDANT LIGHTS 2L **SUSPENSIONS 2L**



5573 MEKKO  
P.116



5574 MEKKO  
P.116

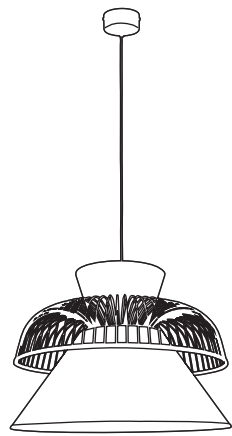

5575 MEKKO  
P.117

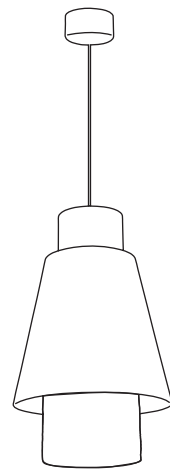

5563 SINGAPOUR  
P.102



5576 SINGAPOUR  
P.102

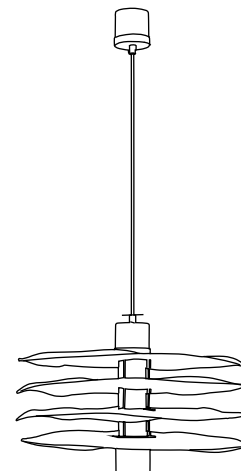

80217 RIVAGE  
P.10

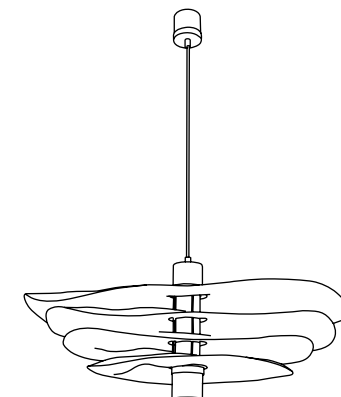

80218 RIVAGE  
P.10

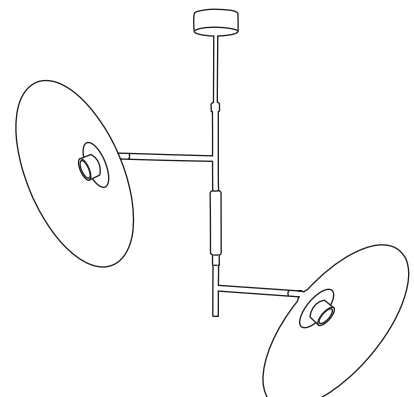

80180 GATSBY  
P.131

151



PENDANT LIGHTS 3L **SUSPENSIONS 3L**

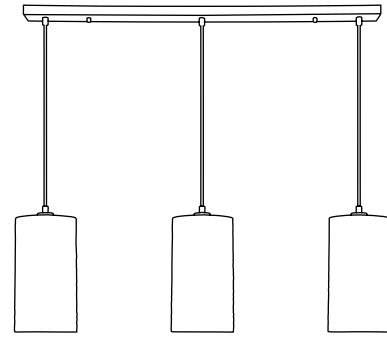

80231 COSINESS  
P.16

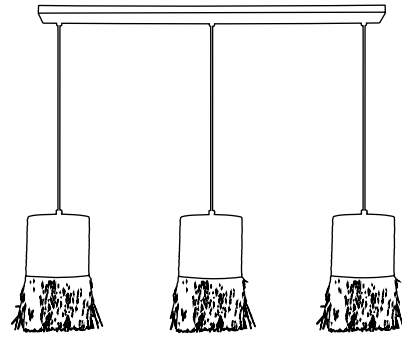

80208 FORMENTERA  
P.26

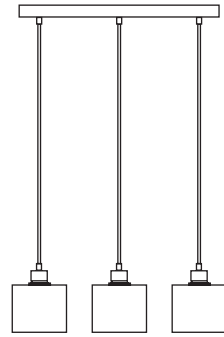

80030 ILO-ILO  
P.30

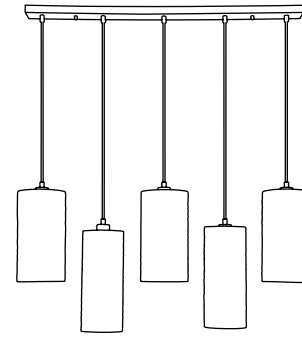

80232 COSINESS  
P.16

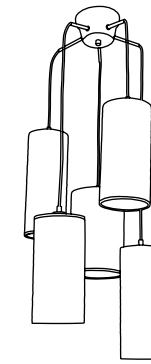

80233 COSINESS  
P.17

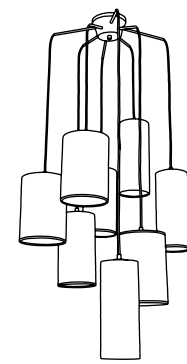

80234 COSINESS  
P.17

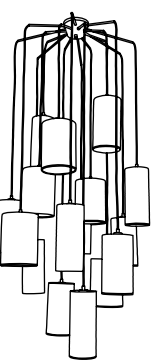

80235 COSINESS  
P.17

152

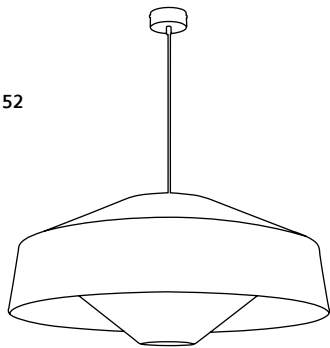

80223 MOKUZAĪ  
P.36

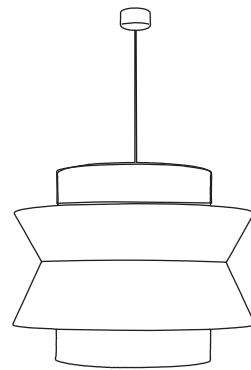

5571 SINGAPOUR  
P.105

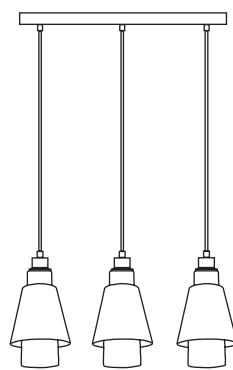

80030 SINGAPOUR  
P.109

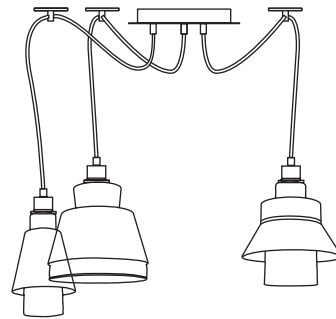

80193 SINGAPOUR  
P.110

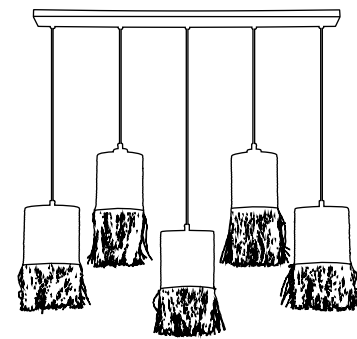

80209 FORMENTERA  
P.26



80210 FORMENTERA  
P.27

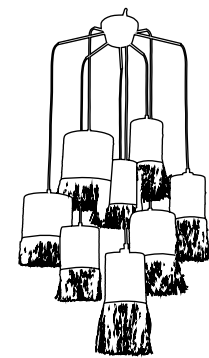

80211 FORMENTERA  
P.27



80212 FORMENTERA  
P.27

153

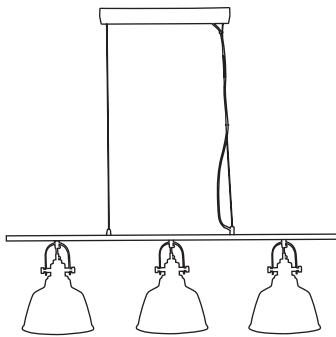

80006 LORD  
P.140

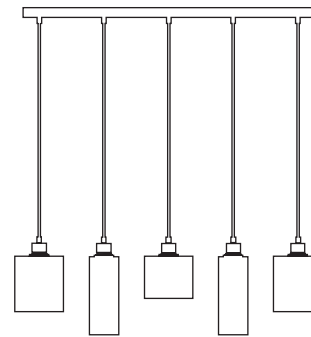

80031 ILO-ILO  
P.30

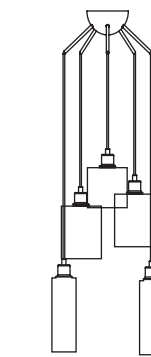

80032 ILO-ILO  
P.31

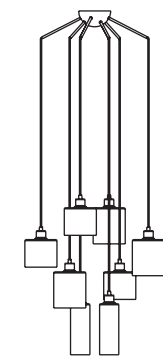

80033 ILO-ILO  
P.31

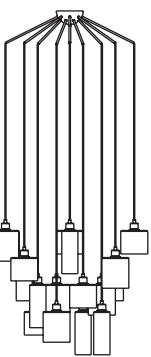

80034  
P.31

PENDANT LIGHTS **SUSPENSIONS**



# SUSPENSIONS

PENDANT LIGHTS

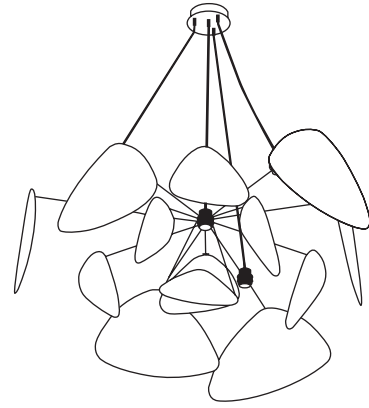

80202 SCREEN  
P.67

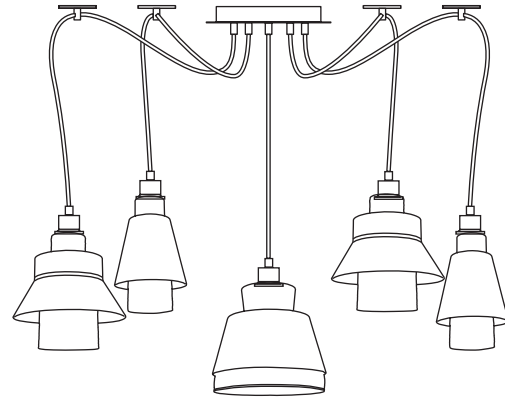

80194 SINGAPOUR  
P.111

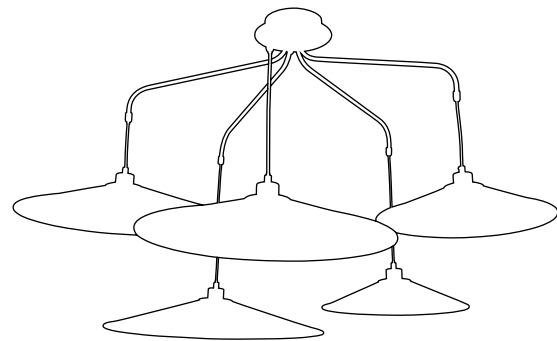

80181 GATSBY  
P.132

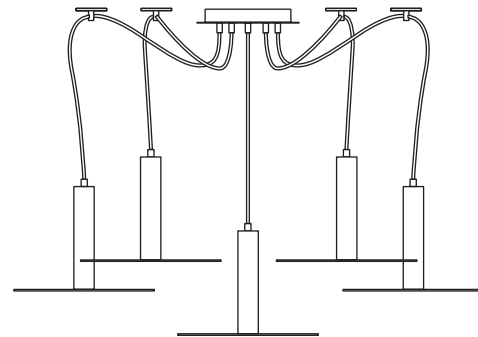

80143 SPY  
P.146

WALL LIGHTS

# APPLIQUES

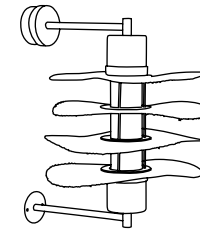

80216 RIVAGE  
P.10

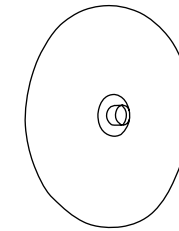

80220 RIVAGE  
P.38

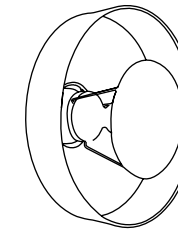

80224 MOKUZAI  
P.37

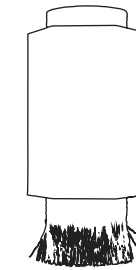

5619 MARRAKECH  
P.45

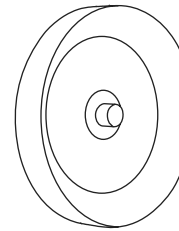

5620/5621 PORTINATX  
P.52

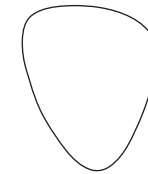

80203 SCREEN  
P.68

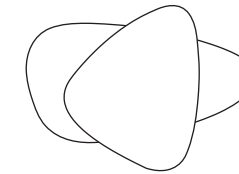

80201 SCREEN  
P.68

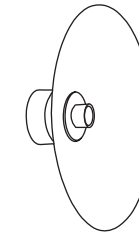

5586 SONIA LAUDET  
P.83

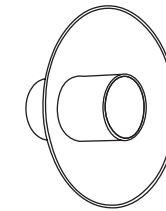

80188 SINGAPOUR  
P.108

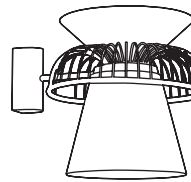

5584 MEKKO  
P.117

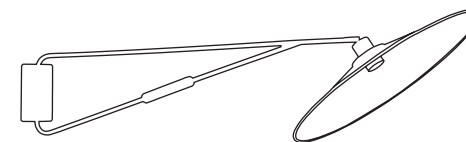

80094 GATSBY  
P.133

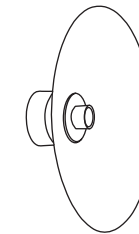

5012 GATSBY  
P.134

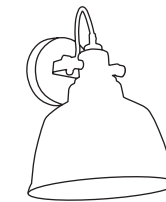

80004 LORD  
P.140

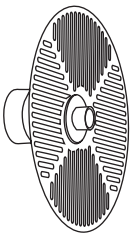

80126 WATERLILY  
P.147

BOXES

# BOÎTES



5587  
SINGAPOUR S  
P.109



5588  
SINGAPOUR M  
P.109

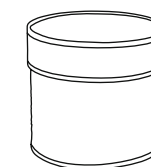

5589  
SINGAPOUR L  
P.109

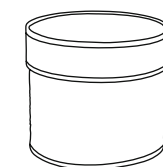

5596  
SINGAPOUR SET DE 3  
P.109



LAMPS

# LAMPES

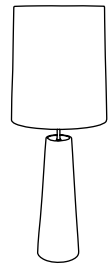

80227/80228 COSINESS  
P.18

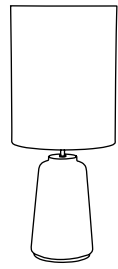

80225 MOKUZAÏ  
P.38

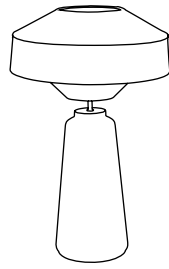

80226 MOKUZAÏ  
P.38

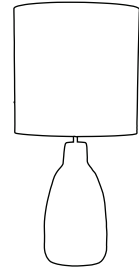

80213 PORTINATX  
P.53

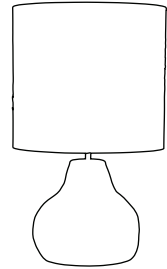

80214 PORTINATX  
P.53

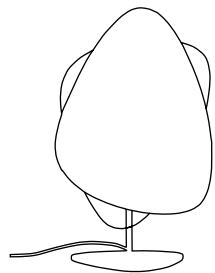

80205 SCREEN  
P.69

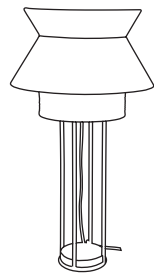

80182 SINGAPOUR  
P.106

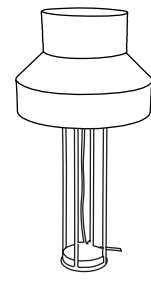

80183 SINGAPOUR  
P.106

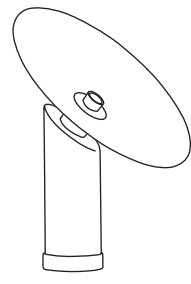

80187 GATSBY  
P.135

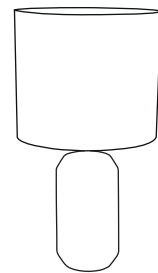

80148 IMPERIAL  
P.142

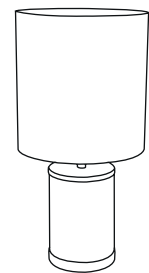

80136 PRECIEUX  
P.143

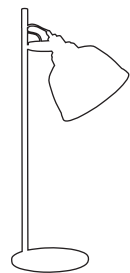

80007 LORD  
P.141

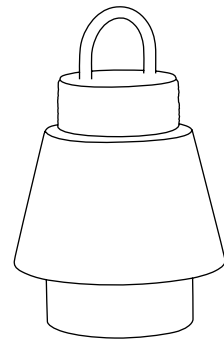

80215 SINGAPOUR  
P.88

OUTDOOR

# EXTERIEUR

FLOOR LAMPS

# LAMPADAIRES

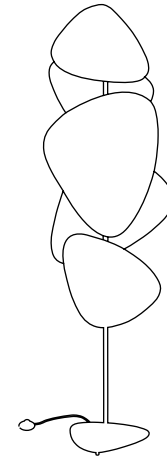

80206 SCREEN  
P.69

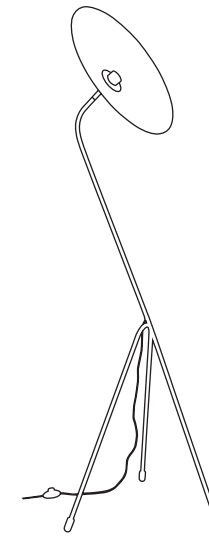

80207 SONIA LAUDET  
P.80

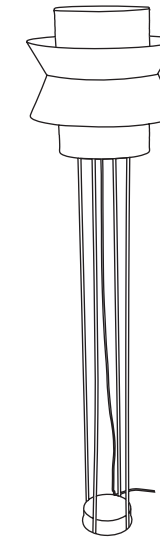

80184 SINGAPOUR  
P.107

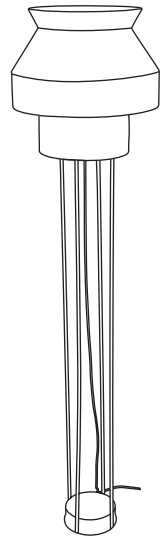

80185 SINGAPOUR  
P.107

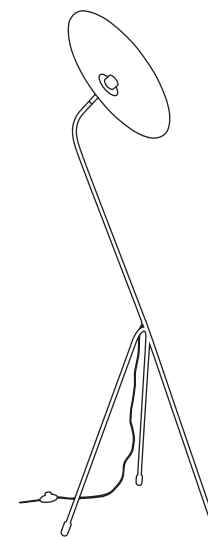

80093 GATSBY  
P.136

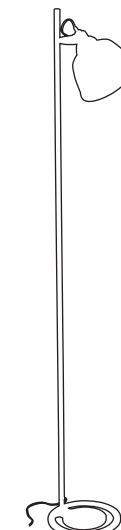

80016 LORD  
P.141

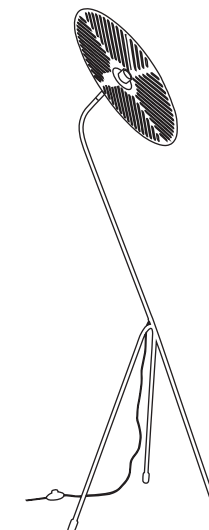

80130 WATERLILY  
P.147



# LÉGENDE

PICTO KEY / LEGEND

PICTO	DÉSIGNATION
	Ce logo signifie que le produit a été dessiné et déposé par l'équipe Design de MARKET SET ou un designer extérieur. Ces produits sont la propriété intellectuelle de MARKET SET. <i>This logo means that the product was drawn and deposited by the design team of MARKET SET or outside designer. Products are the intellectual property of MARKET SET.</i>
	Produit fabriqué en France. <i>Product made in France.</i>
	Abat-jour fabriqué en France. <i>Lampshade made in France.</i>
	Produit fabriqué en Europe. <i>Product made in Europe.</i>
	Base fabriqué au Portugal. <i>Base made in Portugal.</i>
	Adaptable DCL : (dispositif de connexion luminaire). Le produit peut être double raccordement : boîtier de connexion standard ou DCL. <i>DCL adaptable (device light connect). The product can be double connecting : case of standard connexion or DCL.</i>
	Classe 1 : luminaire avec prise de terre. <i>fixture with ground wire.</i>
	Classe 2 : luminaire avec double isolation ou isolation renforcée. <i>reinforced or double insulation.</i>
	Classe 3 : luminaire très basse tension. <i>low voltage luminaire.</i>
<b>1X</b>	Nombre d'ampoule nécessaire au fonctionnement du luminaire. <i>Number of bulbs necessary for usual functionary of the luminaire.</i>
	Ampoule non incluse. <i>Bulb not included.</i>
<b>LED</b>	LED intégrée. <i>Integrated LED.</i>
Type d'ampoule <i>Bulb type</i>	E14  E27  E40  G9  G4
	Interrupteur on-off. <i>Switch on-off.</i>
	Produit équipé d'un variateur. Ne fonctionne pas avec une ampoule CFL. Fonctionne avec une ampoule LED dimmable. <i>Product equipped with a dimmer. Doesn't work with a CFL bulb. Works with a dimmable LED bulb.</i>
<b>Fonction Mémoire</b>	L'interrupteur / variateur mémorise la dernière intensité lumineuse. <i>Switch dimmer with intensity memory.</i>
<b>TOUCH 3 intensités</b>	S'allume au toucher. Ne fonctionne pas avec une ampoule fluocompacte. <i>Lights up on contact. Doesn't functionar with a fluocompact bulb.</i>
<b>NEW</b>	Nouveauté 2022. <i>2022 New product.</i>

# LÉGENDE

PICTO KEY / LEGEND

PICTO	DÉSIGNATION
<b>Boîtier Isodome</b>	Boîtier isodome. <i>Connecting box.</i> Interrupteur au pied. <i>Foot switch.</i>
	DEEE : Ne peut être jeté avec les autres déchets, collecte sélective en vue de sa valorisation, réutilisation ou recyclage. <i>DEEE - Can't be dropped together with the other waste, selective collection so as to be valorised, reused or recycled.</i>
<b>CE</b>	Sigle CE - Ce pictogramme signifie que le produit est conforme aux normes européennes en vigueur. <i>EC symbol: product compliant with European applicable standards.</i>

## Température de couleur *Colour temperature*

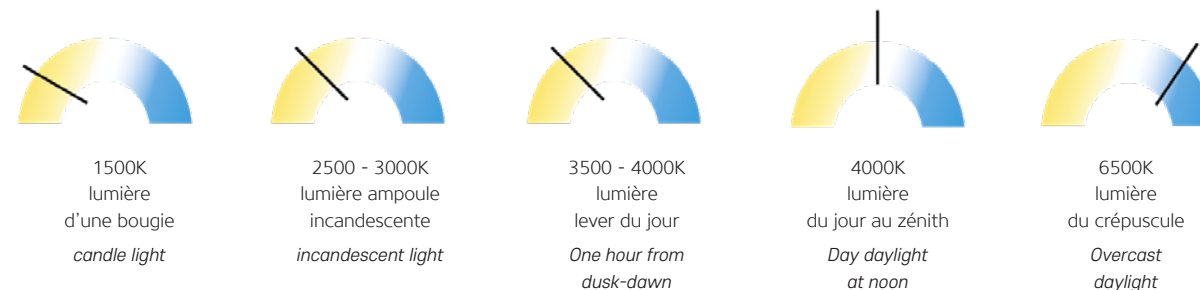

**TEMPÉRATURE DE COULEUR :** couleur apparente de lumière émise. Elle s'exprime en degrés Kelvin (°K).

Elle permet de classer les lampes en lumière chaude <3000°K, lumière intermédiaire : 4000°K et lumière froide > 4000°K.

*COLOUR TEMPERATURE: colour visible in emitted light. This is expressed in degrees Kelvin (°K). It enables lamps to be classified in terms of warm light: <3000°K, intermediate light: 4000°K and cool light: > 4000°K.*

## Normes *Standards*

Tous nos produits respectent la norme européenne en vigueur pour les Luminaires : NF-EN60598-1

Nos produits respectent également les normes REACH, RoHS, ERP...

Ils respectent également le règlement délégué (UE) N°874/2012 de la commission du 12 juillet 2012, complétant la directive 2010/30/UE du parlement européen et du conseil en ce qui concerne l'étiquetage énergétique des lampes électriques et des luminaires.

*All of our products adhere to the current European standard for lighting, NF-EN60598-1 They also meet the REACH, RoHS, ERP... standards.*

*They also comply with the delegated regulation (UE) N°874/2012 from the 12 July 2012, that complete the 2010/30/UE directive from the european parliament and from the council regarding the lightings energy labelling.*



# INDEX

5010	Suspension cover GATSBY D70	130	80148	Lampe IMPERIAL	142
5012	Applique GATSBY D40	134	80180	Plafonnier GATSBY 2L	131
5563	Suspension SINGAPOUR S	102	80181	Plafonnier GATSBY 5L	132
5564	Suspension SINGAPOUR ML	104	80182	Lampe SINGAPOUR	106
5565	Suspension SINGAPOUR M	103	80183	Lampe SINGAPOUR	106
5571	Suspension SINGAPOUR XXL	105	80184	Lampadaire SINGAPOUR	107
5573	Suspension MEKKO S	116	80185	Lampadaire SINGAPOUR	107
5574	Suspension MEKKO M	116	80187	Lampe GATSBY	135
5575	Suspension MEKKO L	117	80188	Applique SINGAPOUR	108
5576	Suspension SINGAPOUR XS	102	80193	Suspension SINGAPOUR 3L grappe	110
5577	Suspension SINGAPOUR XM	103	80194	Suspension SINGAPOUR 5L grappe	111
5578	Suspension SINGAPOUR XML	104	80201	Applique SCREEN 2L	68
5584	Applique MEKKO S	117	80202	Suspension SCREEN XXL	67
5585	Suspension SONIA LAUDET D60	82	80203	Applique SCREEN	68
5586	Applique SONIA LAUDET D40	83	80205	Lampe SCREEN	69
5587	Boîte SINGAPOUR S	109	80206	Lampadaire SCREEN	69
5588	Boîte SINGAPOUR M	109	80207	Lampadaire SONIA LAUDET	80
5589	Boîte SINGAPOUR L	109	80208	Suspension FORMENTERA 3L	26
5596	Boîte SINGAPOUR SET DE 3	109	80209	Suspension FORMENTERA 5L	26
5612	Suspension MARRAKECH S	44	80210	Suspension FORMENTERA 5L grappe	27
5613	Suspension MARRAKECH M	44	80211	Suspension FORMENTERA 8L	27
5614	Suspension MARRAKECH L	45	80212	Suspension FORMENTERA 16L	27
5615	Suspension MARRAKECH XL	45	80213	Lampe PORTINATX M	53
160 5616	Suspension FORMENTERA 1L	26	80214	Lampe PORTINATX L	53
5617	Suspension SINGAPOUR XL	105	80215	Baladeuse SINGAPOUR	88
5618	Suspension COSINESS Ø18	16	80216	Applique RIVAGE S	10
5619	Applique MARRAKECH	46	80217	Suspension RIVAGE 2L M	10
5620	Applique PORTINATX Ø40	52	80218	Suspension RIVAGE 2L L	10
5621	Applique PORTINATX Ø50	52	80219	Suspension RIVAGE 1L S	11
80004	Applique LORD	140	80220	Applique RIVAGE XS	11
80005	Suspension LORD	140	80221	Suspension MOKUZAI Ø38	36
80006	Suspension LORD 3L	140	80222	Suspension MOKUZAI Ø58	36
80007	Lampe LORD	141	80223	Suspension MOKUZAI Ø78	36
80016	Lampadaire LORD	141	80224	Applique MOKUZAI Ø38	37
80029	Suspension ILO-ILO 1L	30	80225	Lampe MOKUZAI M	38
80030	Suspension ILO-ILO 3L	30	80226	Lampe MOKUZAI L	38
80031	Suspension ILO-ILO 5L	30	80227	Lampe COSINESS	18
80032	Suspension ILO-ILO 5L	31	80228	Lampe COSINESS	18
80033	Suspension ILO-ILO 8L	31	80229	Suspension SCREEN XS	66
80034	Suspension ILO-ILO 16L	31	80230	Suspension SCREEN S	66
80093	Lampadaire GATSBY	136	80231	Suspension COSINESS 3L	16
80094	Applique GATSBY DÉPORTÉ	133	80232	Suspension COSINESS 5L	16
80125	Suspension WATERLILY	147	80233	Suspension COSINESS 5L	17
80126	Applique WATERLILY	147	80234	Suspension COSINESS 8L	17
80130	Lampadaire WATERLILY	147	80235	Suspension COSINESS 16L	17
80136	Lampe PRECIEUX	143			
80142	Suspension SPY 1L	146			
80143	Suspension SPY 5L	146			
80145	Suspension SCREEN XL	67			



# RÉSEAU COMMERCIAL *Sales forces*

## MARKET SET

LA LUMIÈRE A DU STYLE

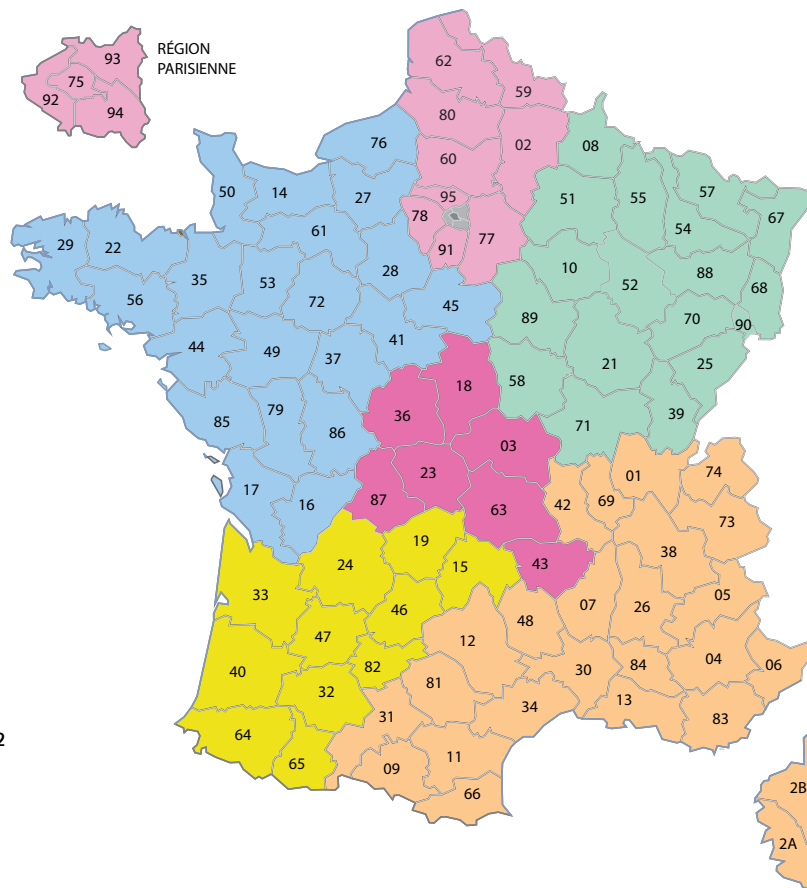

- Caroline LYMOUSI : 06 84 21 75 27  
caroline.lymousi@marketset.fr  
ADV : benjamin.delerue@marketset.fr
- Richard DRYK : 06 74 79 93 60  
richard.dryk@marketset.fr  
ADV : joanna.gimenez@marketset.fr
- Sandrine RADONDY : 06 76 96 12 82  
sandrine.radondy@marketset.fr  
ADV : benjamin.delerue@marketset.fr
- SECTEUR EST  
ADV : benjamin.delerue@marketset.fr
- SECTEUR SUD-OUEST  
ADV : benjamin.delerue@marketset.fr
- SECTEUR CENTRE  
ADV : benjamin.delerue@marketset.fr

162

**PASCAL RADONDY**  
Directeur commercial  
05 56 49 13 66

**JULIEN LAMOURET**  
Directeur des ventes  
Responsable DOM-TOM  
05 56 49 13 66

**DÉPARTEMENT FRANCE**  
05 56 49 80 34  
contact@marketset.fr  
Responsable grands comptes  
joanna.gimenez@marketset.fr

**DÉPARTEMENT EXPORT**  
+33 533 89 41 50  
export@marketset.fr



**ESPAGNE / PORTUGAL**  
José Luis ARAMBILLET  
+34 606 98 26 40  
joseluis.arambillet@corep.com  
ADV : export@marketset.fr



**POLOGNE**  
Dagmara MASTERNAK  
+48 519 118 354  
dagmara.masternak@gmail.com  
dagmara.masternak@inlivio-agency.pl  
ADV : export@marketset.fr



**GRECE**  
KOUROUPIS Representations  
+30 21 06 82 82 80  
kouroupis\_n@yahoo.com  
ADV : export@marketset.fr



**BELGIQUE / LUXEMBOURG**  
Aline RATY - Smart'in Home  
+32 472 68 21 16  
agency.aline@gmail.com  
ADV : export@marketset.fr



**PAYS-BAS**  
Pascal ZEGERS - Design Tales Agencies  
Office +31 851 30 18 45  
Mobile +31 627 65 89 45  
pascal@designtales.nl  
info@designtales.nl  
ADV : export@marketset.fr



**SCANDINAVIE**  
Franck PHILIPPE-MOSAIQUE  
+45 21 74 33 10  
franck@mosaique.dk  
ADV : export@marketset.fr



**ISLANDE**  
Maxime SAUVAGEON  
+354 762 24 66  
contact@aboutiquedesign.is  
ADV : export@marketset.fr

656876





# MARKET SET

LA LUMIÈRE A DU STYLE

Rue Radio-Londres  
CS50001 - 33323 BÈGLES CEDEX (FRANCE)  
Tél. 05 56 49 80 34  
Fax 05 56 85 08 28  
Mail : [contact@marketset.fr](mailto:contact@marketset.fr)

