

COMFORT

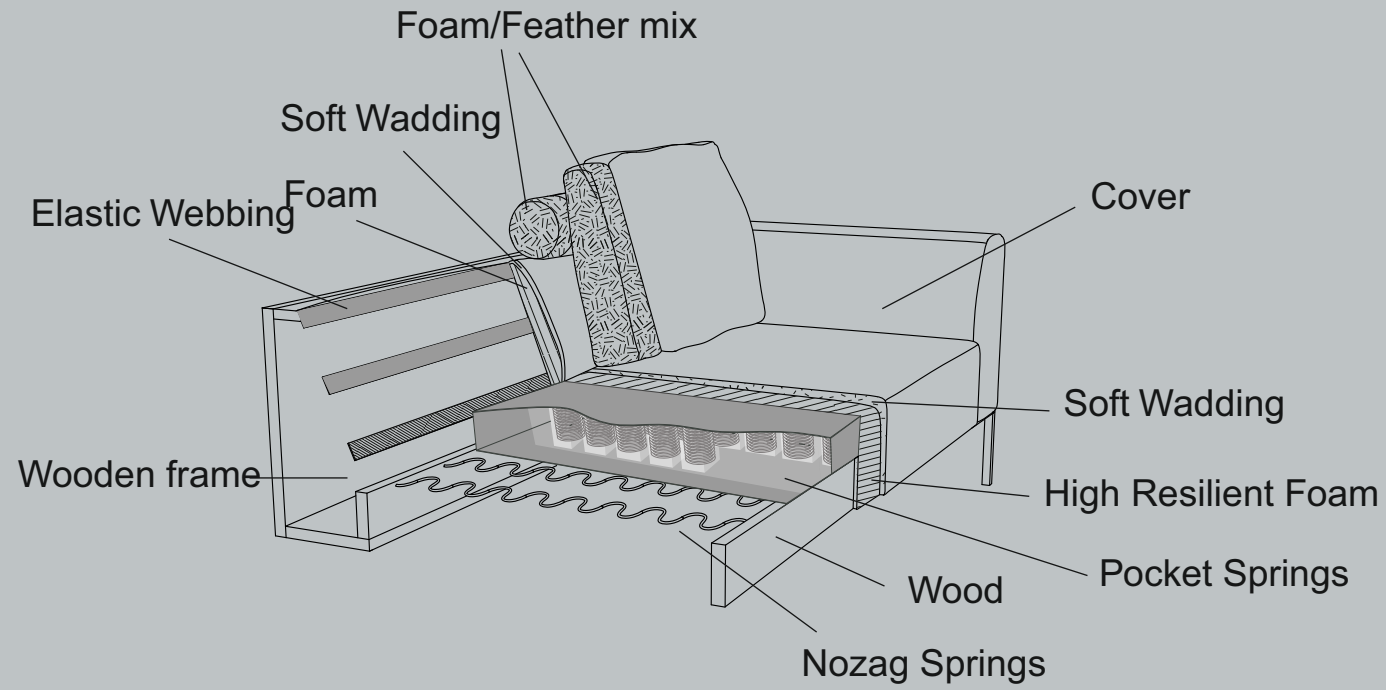

DIMENSIONS

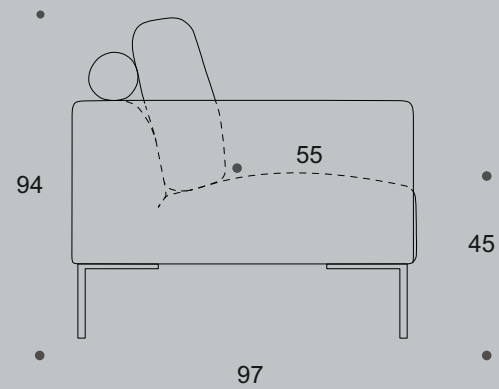

DESIGN ELEMENTS

20 Modules
Available in fabric and leather

HOW TO DESIGN

1. Choose comfort 154
2. Choose combination
3. Choose fabric or leather
4. Choose legs

LEGS



Vasa an exclusive modular stand-alone sofa system, that is designed with perfect proportions and superior comfort in mind. The modular system gives you endless opportunities for combinations of your choice.

VASA

COMBINATIONS

3-seater **3221**

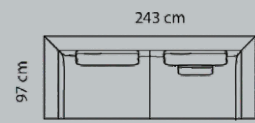

2½-seater **2521**

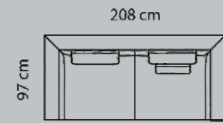

2-seater **2221**

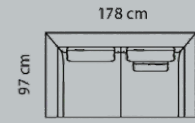

Foot rest **1760**

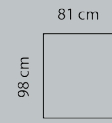

Corner **1620**

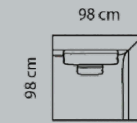

Shown Mirrored Left Right **1410**
1405

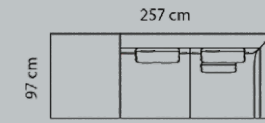

Shown Mirrored Left Right **1430**
1425

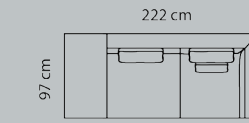

Shown Mirrored Left Right **1810**
1805

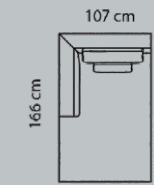

| Price group | 3-seater | | | 2½-seater | | | 2-seater | | | Foot rest | | | Corner | | | Open-end Large | | | Open-end Small | | | Chaiselong | | |
|---------------------|----------|------------|-----|-----------|------------|-----|----------|------------|-----|-----------|------------|-----|----------|------------|-----|----------------|------------|-----|----------------|------------|-----|------------|------------|-----|
| | M3: 1,37 | Metal legs | | M3: 1,17 | Metal legs | | M3: 1,01 | Metal legs | | M3: 0,25 | Metal legs | | M3: 0,55 | Metal legs | | M3: 1,44 | Metal legs | | M3: 1,30 | Metal legs | | M3: 1,03 | Metal legs | |
| | Brushed | Black | Oak | Brushed | Black | Oak | Brushed | Black | Oak | Brushed | Black | Oak | Brushed | Black | Oak | Brushed | Black | Oak | Brushed | Black | Oak | Brushed | Black | Oak |
| 1 | | | | | | | | | | | | | | | | | | | | | | | | |
| 2 | | | | | | | | | | | | | | | | | | | | | | | | |
| 3 | | | | | | | | | | | | | | | | | | | | | | | | |
| 4 | | | | | | | | | | | | | | | | | | | | | | | | |
| 5 | | | | | | | | | | | | | | | | | | | | | | | | |
| Eton w. Split | | | | | | | | | | | | | | | | | | | | | | | | |
| Eton | | | | | | | | | | | | | | | | | | | | | | | | |
| Savoy w. split | | | | | | | | | | | | | | | | | | | | | | | | |
| Savoy / Elegance | | | | | | | | | | | | | | | | | | | | | | | | |
| Century | | | | | | | | | | | | | | | | | | | | | | | | |
| Waldorf | | | | | | | | | | | | | | | | | | | | | | | | |
| Vintage | | | | | | | | | | | | | | | | | | | | | | | | |
| Pullman | | | | | | | | | | | | | | | | | | | | | | | | |
| Boxes of legs incl. | | | 2 | | | 2 | | | 2 | | | 2 | | | 2 | | | 2 | | | 2 | | | 2 |

Shown Mirrored Left Right **3210**
3205

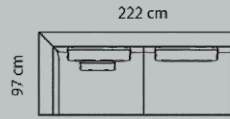

3220

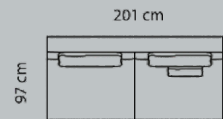

Shown Mirrored Left Right **2510**
2505

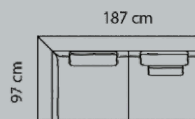

2½-seater - no arms **2520**

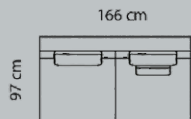

Shown Mirrored Left Right **2210**
2205

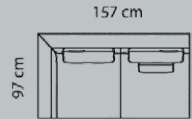

2-seater NO arms **2220**

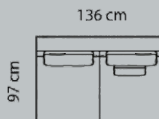

Additional cushion

Large **100 0026**

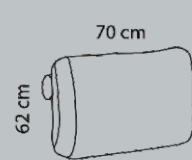

Deco cushions

100 0024

100 0025

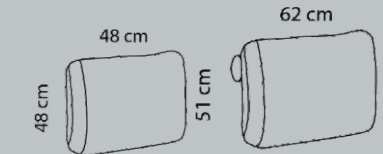

| Price group | 3-seater with 1 arm | | | 3-seater - no arms | | | 2½-seater with 1 arm | | | 2½-seater - no arms | | | 2-seater with 1 arm | | | 2-seater NO arms | | | Back cushion for 3-seater | | | |
|---------------------|---------------------|------------|-----|--------------------|------------|-----|----------------------|------------|-----|---------------------|------------|-----|---------------------|------------|-----|------------------|------------|-----|---------------------------|----------|----------|--|
| | M3: 1,25 | Metal legs | | M3: 1,13 | Metal legs | | M3: 1,06 | Metal legs | | M3: 0,94 | Metal legs | | M3: 0,89 | Metal legs | | M3: 0,78 | Metal legs | | M3: 0,12 | M3: 0,01 | M3: 0,11 | |
| | Brushed | Black | Oak | Brushed | Black | Oak | Brushed | Black | Oak | Brushed | Black | Oak | Brushed | Black | Oak | Brushed | Black | Oak | | | | |
| 1 | | | | | | | | | | | | | | | | | | | | | | |
| 2 | | | | | | | | | | | | | | | | | | | | | | |
| 3 | | | | | | | | | | | | | | | | | | | | | | |
| 4 | | | | | | | | | | | | | | | | | | | | | | |
| 5 | | | | | | | | | | | | | | | | | | | | | | |
| Eton w. Split | | | | | | | | | | | | | | | | | | | | | | |
| Eton | | | | | | | | | | | | | | | | | | | | | | |
| Savoy w. split | | | | | | | | | | | | | | | | | | | | | | |
| Savoy / Elegance | | | | | | | | | | | | | | | | | | | | | | |
| Century | | | | | | | | | | | | | | | | | | | | | | |
| Waldorf | | | | | | | | | | | | | | | | | | | | | | |
| Vintage | | | | | | | | | | | | | | | | | | | | | | |
| Pullman | | | | | | | | | | | | | | | | | | | | | | |
| Boxes of legs incl. | | | 2 | | | 2 | | | 2 | | | 2 | | | 2 | | | 2 | n.a.: not available | | | |

Additional connector for foot rest 93200315

Only for use if foot rest is attached to base modules. Then 2 connectors are needed!

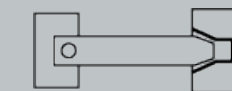

Connectors are otherwise included in base modules

Remember to choose legs!

The last 3 digits in the item no. determines the type of legs

Oiled oak **003**
Brushed metal **020**
Black metal **040**

Ex.: 3-seater with black metal legs: 1543221xxxx040

| VASA | Module | Fabric | Legs |
|------|--------|--------|------|
| 154 | 3221 | xxxx | 040 |

All measurements are approximate. Please allow for a tolerance of +/- 3 cm.

One piece