



VERPAN

Design by Verner Panton

CONTENTS /

Frontpage image:
Welle 5 / Reflex 119, Kvadrat
Welle 4 / Baru 740, Sacho
Pantop 023 Table Lamp / Metallic

	INTRO	04
VERNER PANTON – MORE RELEVANT THAN EVER		06

HOME

	ENTRANCE	10
AT HOME WITH/ TRINE KJÆR		26
	KITCHEN	30
	DINING	38
	LIVING	50
AT HOME WITH/ MICHAEL DANSK		64
	OUTDOOR	70
FOR THE FUTURE/ SUSTAINABILITY		76

PRODUCT OVERVIEW

	FURNITURE	80
UPHOLSTERY PROGRAM		86
	LIGHTING	88
	ACCESSORIES	96

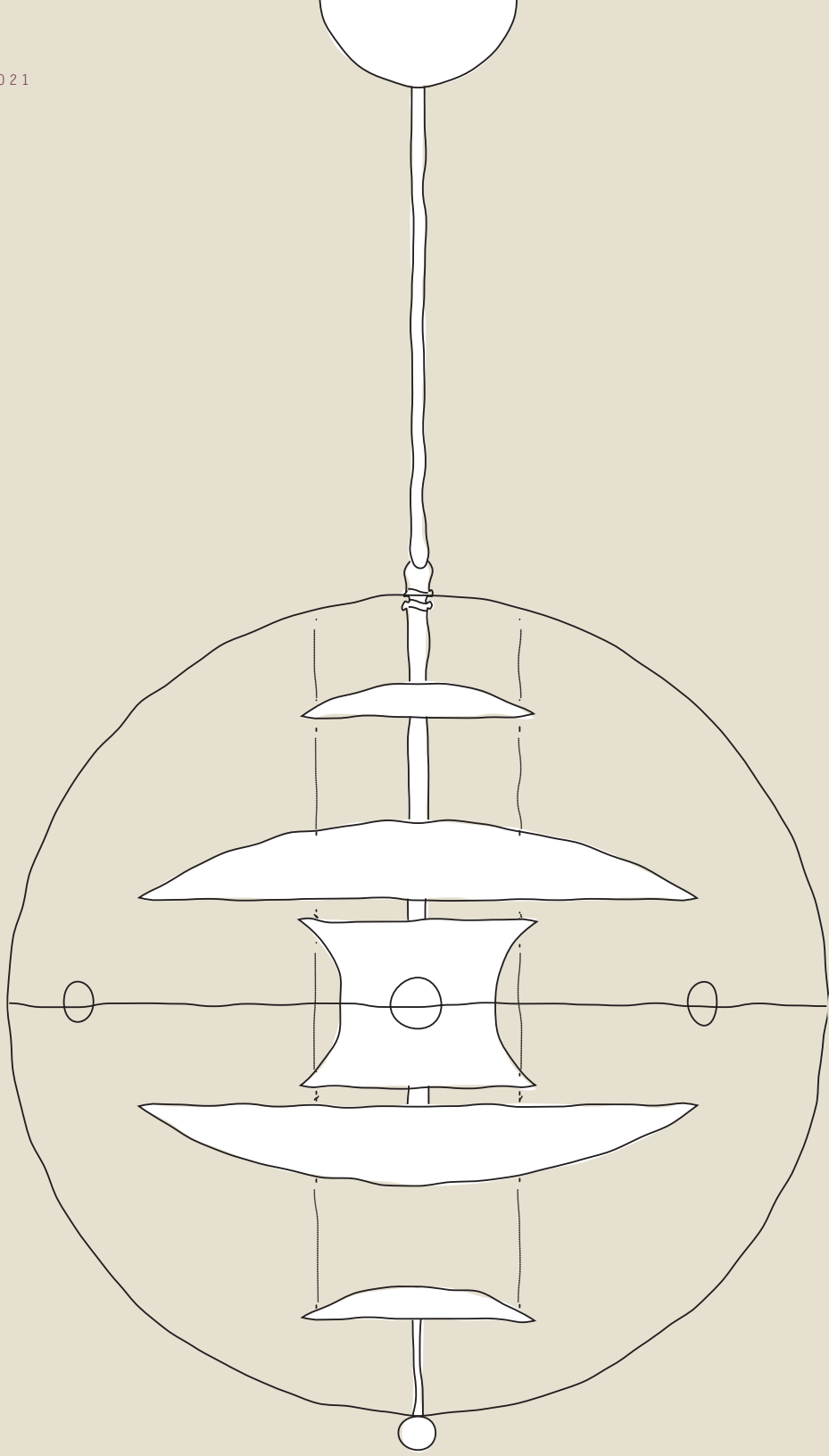

INTRODUCTION

Room for Excitement.

The purpose of our collection is to bring excitement to everyday life and help materialize your personal expression through products that are not only aesthetic and purposeful, but also unique, and timeless and that adds value to your space.

Being able to choose what feels right to you is essential, and that is what the Verpan collection offers. We continuously tap into Panton's heritage when re-imagining products and solutions that help us solve modern challenges and rethink the ways we live, work and meet.

Our collection of furniture, lighting and accessories is available in a variety of colours, finishes, fabrics and more that lets you get creative and allows you to find the pieces that positively influence your wellbeing.

Verner Panton fully believed in the importance of creating an attractive space over the importance of the single object. He had a holistic approach to design and once stated: "the relationship to the environment is much more important than a single chair or object. The space, the colours, the furniture, the textiles and the lighting must be thought and experienced together. The attractive environment can only be created when you really master the whole".

Explore our collection and get excited.



MORE RELEVANT THAN EVER

Verner Panton.

Verner Panton (1926-1998) was a man of many facets. His journey began with early dreams of making it as an artist, which later led to an education in architecture and him finally finding his place in the world of design. Along the way, he was mentored by the likes of Arne Jacobsen and Poul Henningsen, who both were instrumental in shaping and influencing him on his path to become one of the most prominent designers of the 20th century.

Throughout his career, Panton enthusiastically embraced new materials and discovered new ways to approach product- and spatial design. His ability to bridge healthy ergonomics and purposeful functionality with imaginative, organic shapes and bold colours - without ever compromising on quality or workmanship - was a constant in his experimental design process and still highly recognized today.

Despite of his provenance and large contribution, Panton was always considered an outsider among his contemporaries of the mid-century Danish Modern era. Always being on the forefront of innovation meant he was never considered mainstream, nor did he aspire to be. He was always more interested in raising questions and challenging the status quo. He was a provocateur. A rebel.

A famous quote by Panton to describe himself and his work was: “The main purpose of my work is to provoke people into using their imagination. Most people spend their lives in dreary, grey-beige conformity, mortally afraid of using colours. By experimenting with lighting, colours, textiles and furniture and utilizing the latest technologies, I try to show new ways to encourage people to use their fantasy and make their surroundings more exciting”.

His work ultimately led him to pursue a future outside of Denmark to find suited collaborators and partners, and he settled in Basel in 1963. During his career, Panton worked with some of the most prolific design companies, carving out a name for himself both in Denmark and abroad.

Panton also became a sought-after interior designer. Among his most recognized installations are the Visiona 0 and Visiona 2 furniture fairs in 1968 and 1970, the 1971 remake of the Varna restaurant in Aarhus and of course the 1969 complete installation for German publisher, Der Spiegel's main offices in Hamburg.

Panton's iconic designs have emerged as contemporary design classics – as strikingly inventive now as they were 50 years ago.

As a reflection of individual style and taste, the home represents a personal concept of wellbeing realized through the use of space, objects, light and colours.

H O M E

ENTRANCE /



Pantop Ø23 Table Lamp / Light Blue
System 1-2-3 Mirror
System 1-2-3 Rack



Pantop 023 Table Lamp / Classic Blue
Barboy / Mushroom
Luna Rug / Dark Sand

System 1-2-3 Lounge Chair Standard / SIK 1003 Kelato Cognac, CAMO
System 1-2-3 Lounge Chair Deluxe / SIK 1003 Kelato Cognac, CAMO
Pantop Ø23 Table Lamp / Classic Blue
Luna Rug / Dark Sand
Barboy / Mushroom





Barboy / White



BARBOY / 1963

Panton designed the Barboy at a time when he was inspired by free, mobile rooms. The idea was that spontaneous conversations could take place without bumping into obstacles.

It was from this spirit that the idea for the Barboy emerged: a mobile storage unit, which, apart from serving as a drinks cabinet in the living room, could also work as a practical little chest of drawers.

Panton's goal was to design a piece of furniture, which, besides providing storage for bottles, glasses and other cocktail utensils, would also be perfect for use in a bedroom, hallway or office.



VP Globe Ø40 Pendant / Brass Finish



Pantop Portable / Bright Red
Series 430 Stool / Phlox 933, Kvadrat



FUN 2TM Table Lamp



Pantop Portable / Warm Yellow



PANTOP Ø23/ 1980

For long, the Pantop series has been a staple of the Verpan collection. The Pantop line's idiom is best described as decorative and elegant.

Keeping with its bell-shaped, widely flaring shade, Pantop offers an almost optimal combination of ambient and functional lighting.

The Pantop is designed to fit into a wide number of settings and interiors. The table lamp fits perfectly in the window sill, bookcase or counter, and the pendant works equally well on its own as it does in clusters giving you the freedom to be creative and create your own personal expression.



Pantop Ø23 Table Lamp / Bright Red, Burgundy, Classic Blue & Metallic



FUN 11DM Pendant / Brass Finish



FUN 1WM Wall Lamp

FUN/ 1964

Many regard the Fun collection as one of Verner Panton's greatest masterpieces in the field of lighting design. Ever since 1964, this pendant lamp has kindled joy and a wealth of stories. The idea for Fun came from Panton's desire to design a lamp, that would cast a diffused light, and have an optimal effect in a coloured interior.

In terms of materials, Panton originally worked with metal discs but was curious to create something brand new and during a visit to Malaysia, he found what he was looking for: delicate seashells with a vibrant, pearly texture.

When the air set them in motion, they produced the most exquisite, delicate sound. At the same time the UN were looking for ways to generate more jobs in developing countries. Panton could help this effort by using seashells for his Fun lamps.

Today, the Fun collection is available in a wide variety of finishes, sizes and include pendants, floor, table and wall pieces.



Spiral SP01 Pendant / Gold



Spiegel Wall Lamp / Brushed Alu



Panto 040 Pendant

@TRINEKJAER_



Trine has a deep appreciation for colour, which shows throughout her home.

AT HOME WITH

Trine Kjær

For the past year, Trine Kjær has been working with Verpan as a sponsored brand ambassador. Trine has for years been fascinated by design and interior design, and early on in life she fell for Verner Pantón's unique designs. Like Verner Pantón, Trine is not afraid to use colours and shapes in her decor, which is naturally expressed in her and her family's beautiful home north of Copenhagen.

Can you briefly introduce yourself and what you do?

My name is Trine Kjær, and I have worked as a content creator and stylist for the last 10 years. My family and I have recently moved to a house north of Copenhagen that we are now decorating.

When did your interest in Verner Pantón design begin?

My first memory with Verner Pantón was the Phantom Chair that one of my girlfriends got in her room. I thought it was the wildest and most futuristic design, and I was completely in love with its multifunctionality.

Which Verner Pantón design is your favorite and why?

There is no doubt. Cloverleaf Sofa has been my favourite piece of furniture for many, many years. It is like no other sofa. It invites conversations, looks like an art installation, but at the same time it is very comfortable and fits perfectly in a home with children.

What role does Verner Pantón's design play in you and your family's daily life

First and foremost, Verner Pantón's designs make me happy. They are sculptural and aesthetic, but at the same time they are actually perfect for families with children. They invite play, and it is always Welle or Cloverleaf my daughter sits in and reads books. I love the combination of how beautiful they are, but also how comfortable and practical they actually are.

In what ways does Verner Pantón inspire you, and how does his design contribute to your style?

I love Verner Pantón's modern aesthetics. It is unpredictable, futuristic and at the same time classic. I love his fascination with round shapes and his understanding of colours, of course.

You have added Welle and Cloverleaf Sofa to your decor, both among Verner Pantón's more unique designs - why did you choose these particular designs?

I am generally very fascinated with organic forms. I love that, unlike most Danish designs, they have soft and not sharp edges, and both designs are statement pieces – that is, furniture you immediately notice, and you want to touch and sit in.





The two-unit Cloverleaf Sofa is upholstered in Vidar by Kvadrat. The iconic sofa is accompanied by the Wire Floor Lamp.

There seems to be a strong connection between the fashion industry and Verner Panton, and in recent years PRADA, Dries van Noten and Danish RAINS have used his designs in different ways. You yourself are also involved in fashion - why do you think that Verner Panton attracts this interest in the industry?

Verner Panton was so ahead of his time. He was brave and used modern materials like steel and plastic, and on top of that he was so good with colours and shapes. His designs are daring but still classic, and you are never in doubt that he is the one who made them. These are exactly the values that most fashion designers would like to be associated with.

Can you put into words how you decorate your home with and work with colours and composition of colours?

Colours are life to me. I love looking at colours, and I think it adds some warmth and personality to my home. At the moment I am very fascinated by primary colours like green, red and blue and I mix them with more douce colours. In our home there are no black things and no white walls. I have learned over the years that I should not be afraid to choose furniture or things in colours. These are always the things I end up being the happiest with. Such as a coloured Chanel bag or a pink Welle. A coloured statement item allows you to keep the rest of the room fairly neutral.



Wire Floor Lamp.



Welle 4 in Vidar by Kvadrat.

Where do you find inspiration for your decor?

I primarily find inspiration in old houses and hotels in Southern Europe. Villa Magnan is my dream place. I am not so Scandinavian oriented although I love a beautiful oak table. I'm more into the slightly more eclectic that I think Verner Panton masters (even though he's Danish). In addition, I love Pinterest, design books and Instagram.

Trine is a sponsored partner of Verpan.

KITCHEN /



Series 430 Bar Stool / Pilot 752, Kvadrat
Series 430 Bar Stool / Pilot 791, Kvadrat



Pantop 023 Pendant / Metallic





Pantop Ø23 Pendant / Burgundy
Series 430 Bar Stool / Phlox 633, Kvadrat



Series 430 Bar Stool / Ria 551, Kvadrat
Series 430 Bar Stool / Phlox 633, Kvadrat

MOON / 1960

Designed in 1960, the Moon represents one of Verner Panton's earliest lighting designs.

The iconic pendant is characterized by its fan-like design with ten ring-shaped aluminium lamellae perfectly positioned to provide a soft, ambient and glare-free light. The blades reflect and filter the light and the pendant changes its appearance depending on the angle at which you view it.

Due to its simplicity in design and white finish, the Moon lamp is incredibly versatile and can work in a number of settings – as a single piece or in clusters.



Moon Pendant / Small

DINING /



FUN ODM Pendant
Pantop Portable / Bright Red
Move Table / Black
Barboy / Lilac Grey
Series 430 Chair / Reflect 204-714-774-884, Kvadrat



Series 430 Chair / Vidar 723, Kvadrat
Series 430 Table Ø120 / Black



System 1-2-3 Dining Standard / Terrain Graphite, Kirkby Design
Pantop 023 Pendant / Mint Grey
Series 430 Table Ø120 / Black
Series 430 Chair / Vidar 723, Kvadrat
Series 430 Stool / Dunes Camel, Sørensen Leather





Welle 4 / Gentle 663, Kvadrat
Pantop Ø23 Table Lamp / Light Blue
Series 430 Table Ø120 / Black
Series 430 Chair / Atom 774, Kvadrat
Series 430 Stool / Reflex 779, Kvadrat
Luna Rug / Grey



Series 430 Chair / Karakorum 003, Dedar
Series 430 Table Ø120 / White
VP Globe Ø40 / Warm Peach

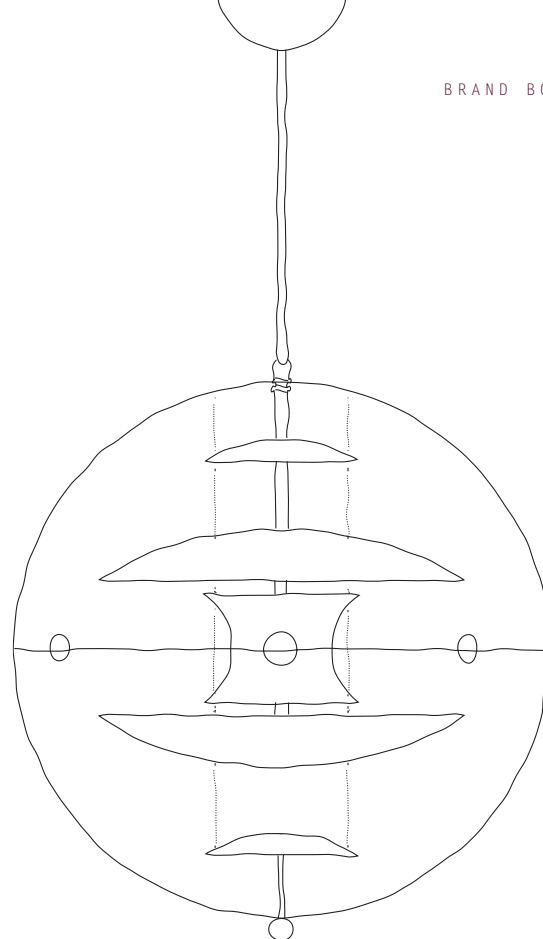

VP GLOBE / 1969

Originally conceived in 1969 by Verner Panton, the VP Globe is arguably the most recognized Panton lighting design.

The decorative pendant features a crystal clear transparent acrylic outer sphere with five internal reflectors suspended by three steel chains.

A little-known story behind the inspiration of Verner Panton's lighting is the Venice influence. Panton was known for his desire to explore, travel and experience different places and cultures. One of his favorite destinations was Venice, Italy, and he paid several visits to the famous 'city on the water'.

It was in fact during one of these visits, that he fell in love with the slightly rose-coloured light emitted by the old street lamps in the city – so much so that he wanted his future lighting designs to simulate that unique experience.

The VP Globe is perhaps the most successful execution of this early inspiration, as its special layered design paired with the acrylic globe emits a warm, soft and ambient light – a signature of Panton.

True to Panton's creative approach, the VP Globe is available in various configurations and sizes – exploring different materials and expressions.

All VP Globes are assembled 100% by hand in Denmark.



FINN 2TM Table Lamp
Hive Pendant / Alu
Series 430 Table 0120 / Black
System 1-2-3 Dining Standard / Vidar 943, Kvadrat
System 1-2-3 Dining Standard / Karakorum 007, Dedar



Hive Pendant / Alu
Series 430 Table Ø120 / Black
System 1-2-3 Dining Standard / Vidar 943, Kvadrat
System 1-2-3 Dining Standard / Karakorum 007, Dedar

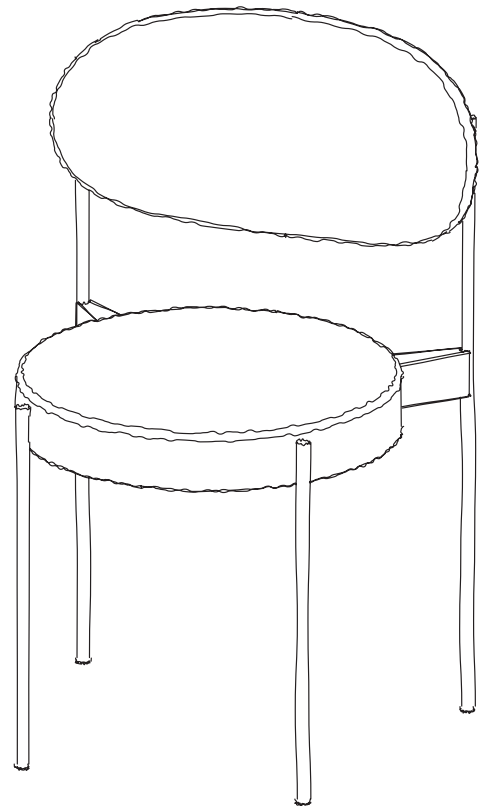

SERIES 430 Chair/ 1967

In 2015, Verpan re-discovered a forgotten dining chair in the Pantón archives. The design was unknown to most, as it only had a brief production run following its original release in 1967.

Based on Pantón's original drawings and notes, Verpan re-imagined the beautiful design to modern standards. Verner Pantón had designed the Series 430 Chair to be a study in simplicity, while providing the same comfort as an armchair.

He did so by applying traditional webbing to the fully upholstered seat to adjust for body weight and create a wide nestling backrest and place it on a slender elegant frame that mounts on the outside of the seat and back.

The Series 430 chair truly is a multipurpose chair and can easily be applied anywhere in a home and with five different frame colours to choose from and a wide variety of upholstery options, the Series 430 can be customized to suit any desired mood, setting or occasion.

Fun fact - the Series 430 Chair is the only four-legged chair designed by Pantón.



Series 430 Chair / Parkland 231, Kvadrat
Series 430 Chair / Hallingdal 180, Kvadrat
Series 430 Table Ø120 / Black
Pantop Pendant / Dusty Rose, Burgundy & Light Blue
Pantop Portable / White

LIVING /



Welle 4 / Gentle 573, Kvadrat
Pantop 023 Table Lamp / Burgundy



VP Globe Ø50 / Glass
VP168 Sofa / Vidar 693, Kvadrat
Welle 5 / Atom 774, Kvadrat
Series 430 Chair / Vidar 723, Kvadrat
Reflect Table Lamp / Red
Wave Rug / Grey







VP168 Sofa / Vidar 693, Kvadrat
Welle 4 / Baru 740, Kvadrat
Welle 5 / Gentle 223, Kvadrat
Pantop Portable / Matte White
Wire Floor Lamp
Mirror Throw / Blue
System 1-2-3 Mirror

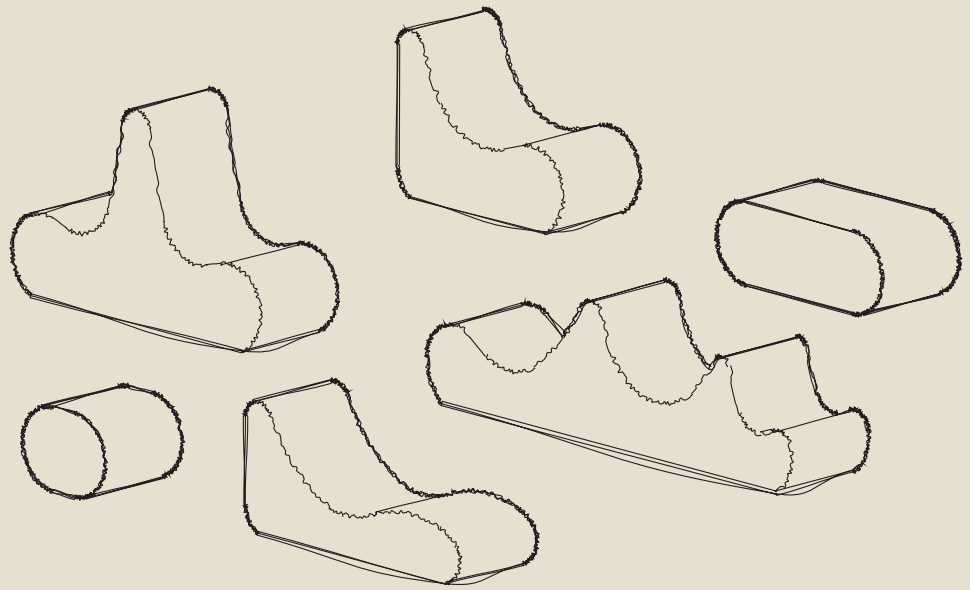

WELLE Lounge/ 1969

To refer to Panton's Welle furniture as mere *lounge furniture* could be considered an understatement. Unmistakably Panton, these wildly imaginative organic shapes represents a sense of free-spirited thinking, unhinged from conventions and tradition – instead sparking our emotions, curiosity and creativity.

Welle is available in six different silhouettes that can either stand alone or go together to create an entire landscape.

The pieces are light and easy to move around.



Mirror Sculptures / 4 Pyramid
Welle 1 / Tonus 508, Kvadrat
Pantop Ø23 Pendant / Burgundy
Luna Rug / Rose



Cloverleaf Sofa / Harald 982, Kvadrat
System 1-2-3 Dining Chair Deluxe / Hallingdal 116, Kvadrat
Pantop Ø23 Table Lamp / Grey Sand
VP Globe Ø50 / Glass
Barboy / White



Flying Chair / Atlas 001, Dedar
Series 430 Stool / Byram 471, Kvadrat
Luna Rug / Grey
Wire Table Lamp



Cloverleaf Sofa / Harald 982, Kvadrat
System 1-2-3 Dining Chair Deluxe / Hallingdal 116, Kvadrat
Pantop Ø23 Table Lamp / Grey Sand
Barboj / White





Cloverleaf Sofa / Karakorum 003, Dedar
Welle 5 / Reflex 0119, Kvadrat
Series 430 Chair / Atlas 001, Dedar
Series 430 Chair / Hallingdal 116, Kvadrat
Series 430 Table Ø120 / White
Mirror Sculptures / 4 Pyramid



CLOVERLEAF Sofa/ 1969

When ordinary just won't do. Designed by Verner Panton in 1969, the Cloverleaf design stands out as one of his most unique works – sculptural, organic aesthetics and functional qualities combined in a modular sofa offering almost infinite opportunities for personal expression.

Cloverleaf was conceived as a sprig of clover, meandering and unfolding as it gets longer. In the middle, the seat is divided by a backrest, which wriggles out of the seat. As well as providing the necessary back support, it also shields you from people sitting on the other side. This one-of-a-kind sofa is one of Panton's masterpieces.

@MICHAELDANSK



Michael lounging in his Welle 4.

AT HOME WITH

Michael Dansk.

Meet Michael Dansk. A Copenhagen-based creative who since childhood has been intrigued by great design and today has turned this fascination into a career.

Tell us a about yourself.

My name is Michael. I am a 32-year-old Copenhagen-based creative consultant working in the field of culture and design. Basically, what I do is tell stories in images and words to bring brands to life. For many years, I worked as a magazine editor before I started my own business a few years ago. Besides this, I share my passion for interior, art and design via my Instagram channel @MichaelDansk. My take on interior is maybe a little more colourful than the typical Scandinavian, but colour and art simply inspire me. I live with my partner and two children in the heart of Copenhagen's lively Nørrebro neighbourhood surrounded by all sorts of cafes, bars and small shops.

How did you get into interior design?

I have always loved interior, growing up in a family of architects, I knew all the big names in Danish design before I was even 10 years old. Until 5 years ago, it was merely a hobby for me. I was working as a fashion editor for a DK magazine and one day, I was simply asked to cover all interior related content as well. From there my career sort of shifted more and more towards interior and design, and today almost all of my clients are within this area. So in a way, my childhood passion ended up growing into a profession.

Where do you find inspiration?

I am lucky to work with a great number of talented people within the field of interior design on a daily basis, so I really get a lot of inspiration from the

people around me and their individual ways of working. Besides this, art is a massive inspiration to me. I collect works by young Scandinavian artists, and often use works of art to set the mood in interior styling and other visual projects. I have always been fascinated by names like Vilhelm Lundstrøm, his way of combining colour and shape is truly genius. Besides this, I think my style is very much influenced by different elements. My background in fashion, my love for travels and culture, my passion for art and my interest in architecture.

What is your relationship with Verner Panton?

Panton and I go way back. I grew up with several Panton designs in my childhood home, and remember seeing a fantastic Panton exhibition at Trapholt museum, when I was a kid. Naturally, the Panton Globe was the first lamp I bought, when I got my first apartment in Copenhagen 10 years ago.

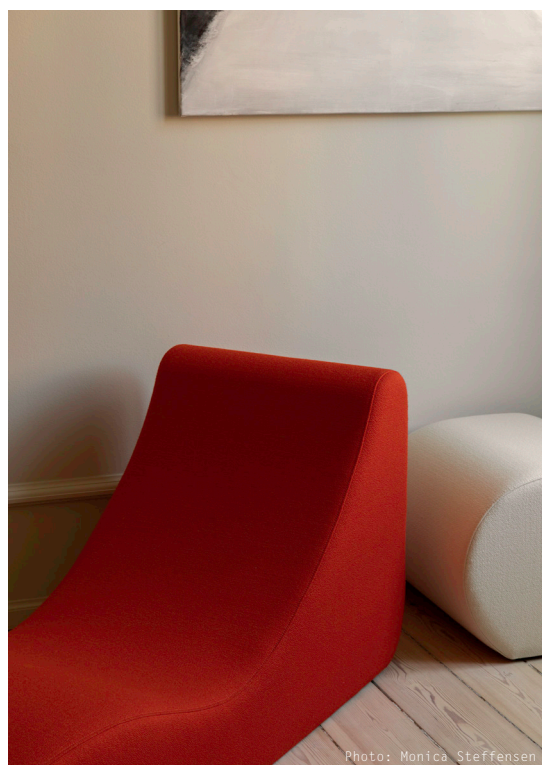

Photo: Monica Steffensen

Welle 4 and Welle 6 (Vidar 542 & 1511. Kvadrat).



A yellow Hive pendant adorn the kitchen.

It is hard to pinpoint, what has been drawing me to Pantons' design. I think it might be his playful approach. I really like his way of experimenting with materials, shapes and colours in a fun and interesting way. Even if many of his iconic pieces are about 50 years old now, they still seem relevant, and have a futuristic edge that I really enjoy.

How do you see Pantons influence today?

Many of Pantons' designs have a rather futuristic look to them and have kept that to this date. In a way, his design keeps feeling fresh and contemporary. I think his approach to form, material and colour is somewhat different to many other big Danish designers, which makes him stand out and makes his design feel rather unique. Also, there is a lot of focus on textures and colour at the moment, and his original designs truly show how to incorporate colour and unusual materials in a fun and easy way.

Favourite design from the Verpan collection?

For me, it is hard to pick a favourite. The Globe is probably the design I liked for the longest time. Recently, I have grown to like some of his furniture pieces more and more. He designed some super cool coffee tables and I really like the System 1-2-3 series in general.

Michael Dansk is a sponsored partner of Verpan.



The Wire Table Lamp and System 1-2-3 Lounge Chair Standard (Pilot 972, Kvadrat) make a wonderful pairing in the living room.

Photo: Monica Steffensen





Panto Pop in yellow fits perfectly on Michael's balcony.

OUTDOOR /



Panto Pop / Dark Green
Pantop Portable / White
Mirror Throw / Yellow & Dark Green



Panto Pop / Grey
Pantop Portable / Black
Mirror Throw / Sand & Dark Green



Pantop Portable / Grey Sand



Mirror Throw / Sand & Dark Green



Cloverleaf In- & Outdoor / Grey
Panto Pop / Yellow
Pantop Portable / White



FOR THE FUTURE

Sustainability Statement.

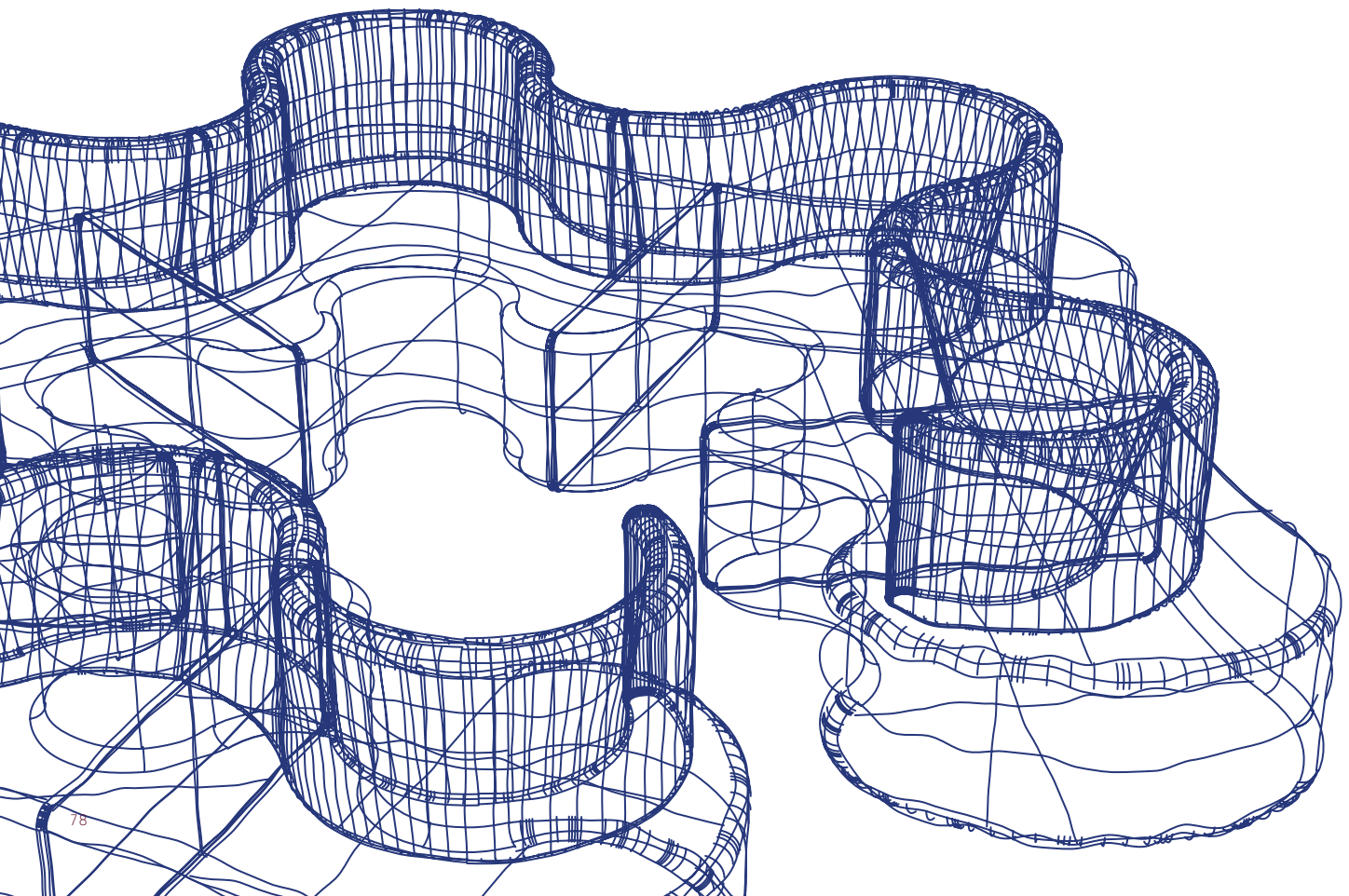

PRODUCT OVERVIEW

Furniture.

SERIES 430 CHAIR

Verner Panton /1967

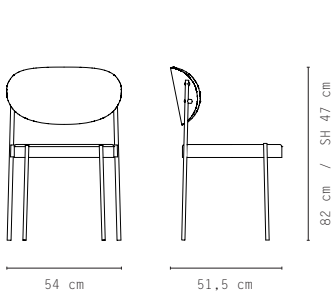

Frame options



Material

FSC-certified wood for seat and back
Elastic band webbing in the seat
CMHR (CRIB 5) or HR (Ca1 117) foam
Brushed stainless steel frame (steel)
Painted or plated metal frame
Felt feet

SERIES 430 BAR STOOL 65

Verner Pantan /1967

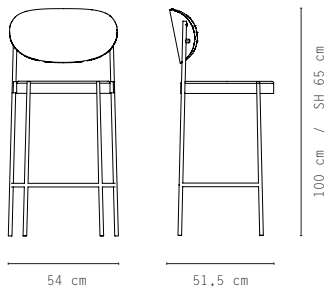

Frame options

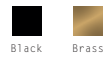

Material

FSC-certified wood for seat and back
Elastic band webbing in the seat
CMHR (CRIB 5) or HR (Ca1 117) foam
Painted or plated metal frame
Felt feet

SERIES 430 BAR STOOL 75

Verner Pantan /1967

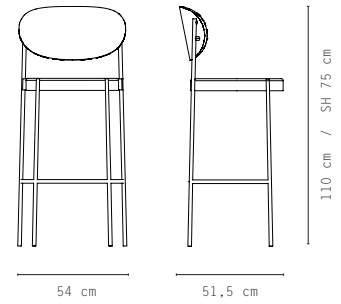

Frame options



Material

FSC-certified wood for seat and back
Elastic band webbing in the seat
CMHR (CRIB 5) or HR (Ca1 117) foam
Painted or plated metal frame
Felt feet

SERIES 430 STOOL

Verner Pantan /1967

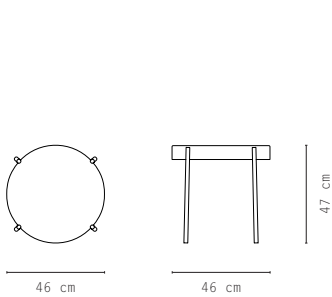

Frame options



Material

FSC-certified wood for seat and back
Elastic band webbing in the seat
CMHR (CRIB 5) or HR (Ca1 117) foam
Brushed stainless steel frame (steel)
Painted or plated metal frame
Felt feet

SYSTEM 1-2-3 DINING

Verner Pantan /1973

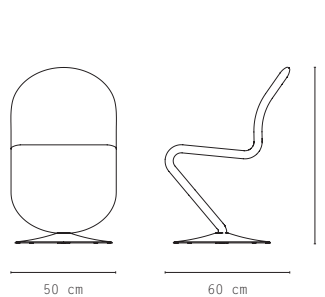

Frame options

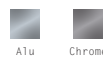

Material

Brushed aluminium base or chrome plated butterfly base
Steel frame
VOSS foam
Various upholstery options

SYSTEM 1-2-3 LOUNGE

Verner Pantan /1973

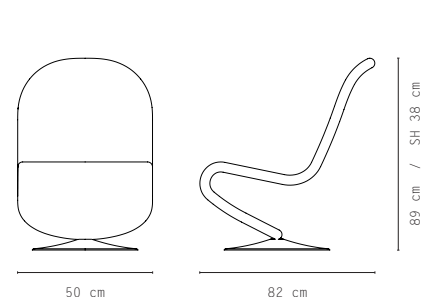

Frame options



Material

Brushed aluminium base
Steel frame
VOSS foam
Various upholstery options

VP168 SOFA

Verner Panton /1987

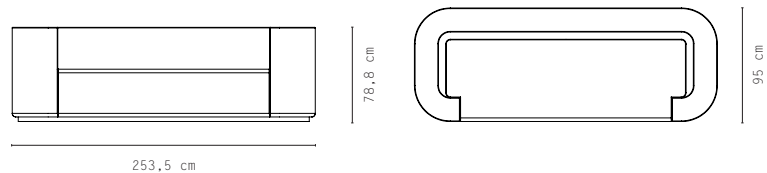

Material

Frame and base in FSC certified wood
 CMHR (CRIB 5) or HR (Ca1 117) foam for seat and backrest
 Pocket springs in seat
 Pillows filled with natural feathers

FLYING CHAIR LOUNGE CHAIR

Verner Panton /1964

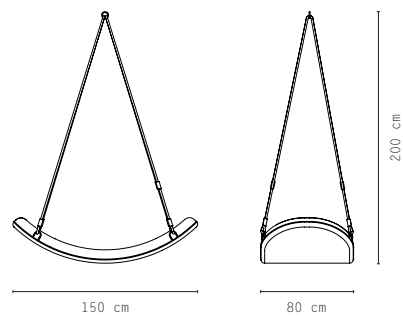

Frame options



Steel

Material

FSC-certified form pressed plywood
 Supporting steel frame
 PU foam
 Polyester ropes with steel fixtures

CLOVERLEAF SOFA UPHOLSTERED

Verner Panton /1969

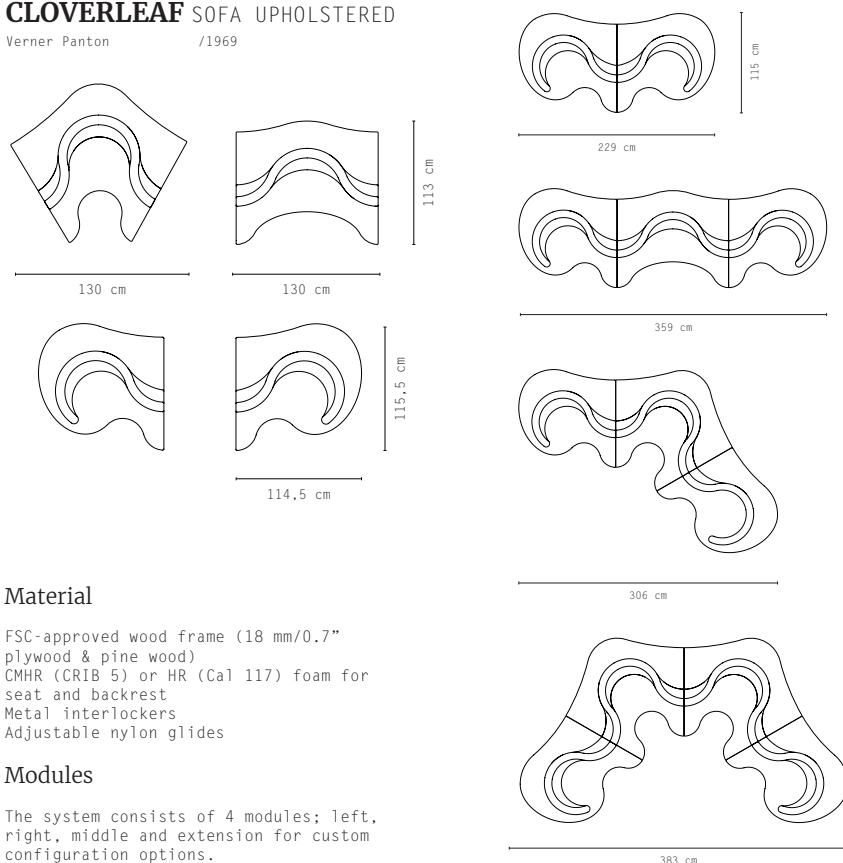

Material

FSC-approved wood frame (18 mm/0.7” plywood & pine wood)
 CMHR (CRIB 5) or HR (Ca1 117) foam for seat and backrest
 Metal interlockers
 Adjustable nylon glides

Modules

The system consists of 4 modules; left, right, middle and extension for custom configuration options.

WELLE 1 LOUNGE CHAIR

Verner Panton /1969

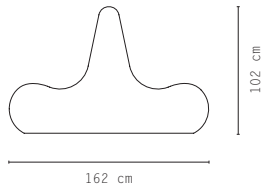

Material

FSC-certified wood frame (15 mm/0.6" plywood)
CMHR (CRIB 5) or HR (Ca1 117) foam

WELLE 2 LOUNGE CHAIR

Verner Panton /1969

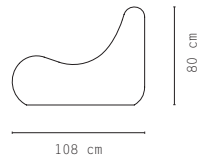

Material

FSC-certified wood frame (15 mm/0.6" plywood)
CMHR (CRIB 5) or HR (Ca1 117) foam

WELLE 3 LOUNGE CHAIR

Verner Panton /1969

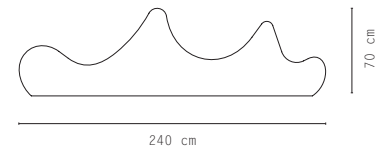

Material

FSC-certified wood frame (15 mm/0.6" plywood)
CMHR (CRIB 5) or HR (Ca1 117) foam

WELLE 4 LOUNGE CHAIR

Verner Panton /1969

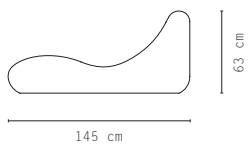

Material

FSC-certified wood frame (15 mm/0.6" plywood)
CMHR (CRIB 5) or HR (Ca1 117) foam

WELLE 5 LOUNGE CHAIR

Verner Panton /1969

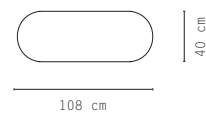

Material

FSC-certified wood frame (15 mm/0.6" plywood)
CMHR (CRIB 5) or HR (Ca1 117) foam

WELLE 6 LOUNGE CHAIR

Verner Panton /1969

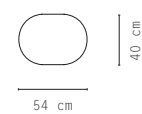

Material

FSC-certified wood frame (15 mm/0.6" plywood)
CMHR (CRIB 5) or HR (Ca1 117) foam

CLOVERLEAF IN- & OUTDOOR

Verner Panton /1969

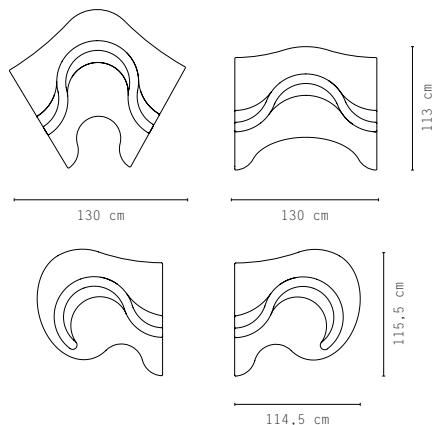

Colours



Material

100% recyclable rotational molded PE polyethylen. In- & outdoor use.

Modules

The system consists of 4 modules; left, right, middle and extension for custom configuration options.

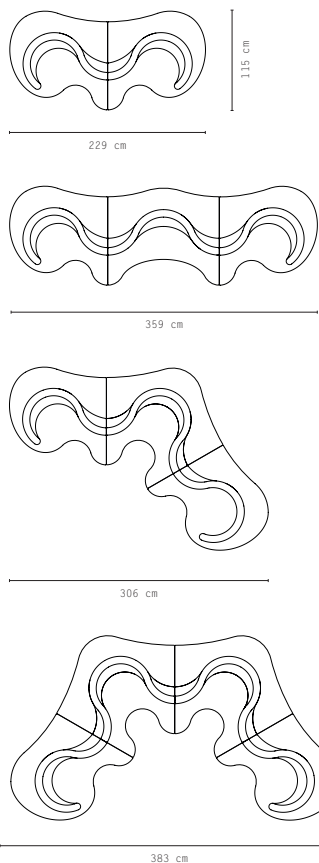

PANTO POP LOUNGE CHAIR

Verner Panton /1967

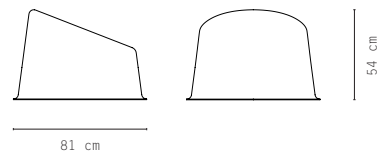

Colours



Material

100% recyclable PP (polypropylene)

SERIES 430 TABLE

Verner Panton /1973

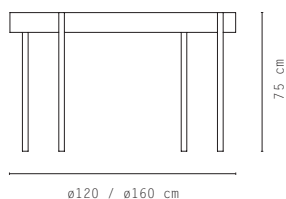

Frame options / Colours



Material

Powder coated metal legs
MDF table top with Fenix nanotech laminate
Height adjustable feet

MOVE TABLE

Verner Panton /1972

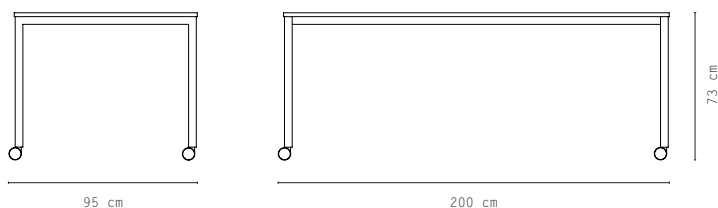

Frame options / Colours



Material

Frame made of powder coated square steel tube
MDF table top with Fenix nanotech laminate
Mounted with lockable TENTE wheels

BARBOY STORAGE
Verner Panton /1963

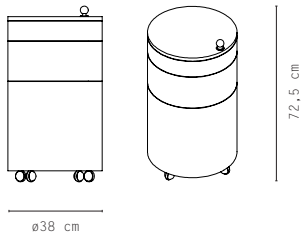

Colours

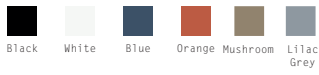

Material

Moulded painted wood
Chrome plated castors

SYSTEM 1-2-3 RACK
Verner Panton /1973

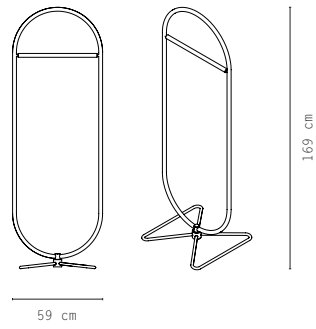

Frame options



Material

Chrome plated steel frame
Chrome plated butterfly base

SYSTEM 1-2-3 MIRROR
Verner Panton /1973

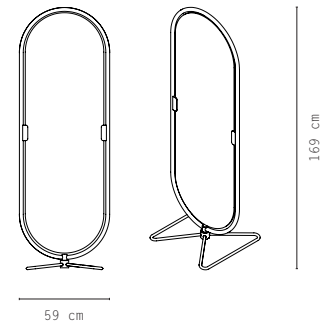

Frame options



Material

Chrome plated steel frame
Chrome plated butterfly base
4mm double sided mirror



Series 430 Chair / Hallingdal 180, Kvadrat

UPHOLSTERY PROGRAM

The Verpan Upholstery Program is an overview of textile and leather available for the Verpan upholstered furniture. The listed fabrics and leathers are available in all colours.

In addition to the options listed, we have tested several other fabrics and entered trade agreements with a number of other suppliers, which enables us to answer most customer needs. We are also happy to upholster furniture using customer's own materials (COM) with extended lead times.

For special requests, please contact our sales team.

Price group	Fabric	System 123 Standard	System 123 Deluxe	Series 430	Cloverleaf Sofa	Welle	Flying Chair	VP 168 Sofa	US Cal. Bull. 117-2013	BS 5852 Part 1 (cigarette & match)
	COM/COL									
1	Kvadrat Remix			●	●	●	()	()	Yes	Yes ¹
1	Kvadrat Canvas	●		●	●	()	()	()	Yes	Yes ¹
1	Kvadrat Relate			●			()		Yes	Yes + BS 5852 Crib 5
2	Kvadrat Parkland			●					Yes	Yes + BS 5852 Crib 5
2	Kvadrat Atlas			●	●	●	()	●	Yes	Yes ¹
2	Kvadrat Steelcut	●	●	●	●	●	()	()	Yes	Yes ¹
2	Kvadrat Steelcut Trio	●	●	●	●	●	()	()	Yes	Yes ¹
2	Skai Parotega		●	●	●	●	()	()		Yes
2	Kvadrat Hallingdal	●	●	●	●	●	●	●	Yes	Yes + BS 5852 Crib 5
2	Kvadrat Tonus	●	●	●	●	●	●	●	Yes	Yes ¹
2	JAB Champion			●			()	●	Yes	Yes + BS 5852 Crib 5
2	JAB Sweet Lovin			●					Yes	(Yes)
2	Kvadrat Divina 3	●	●	●	●	●	●	●	Yes	Yes + BS 5852 Crib 5
2	Kvadrat Divina MD	●	●	●	●	●	●	●	Yes	Yes + BS 5852 Crib 5
2	Kvadrat Divina Melange	●	●	●	●	●	●	●	Yes	Yes + BS 5852 Crib 5
3	Kvadrat Harald		●	●	●		()	●		
3	Sacho Cuba		●	●			()	●	(Yes)	(Yes)
3	Kvadrat Vidar	●	●	●	●	●	●	●	Yes	Yes ¹
3	Dedar Adamo & Eva	()	()	●			()	●		
4	Kvadrat Melange Nap	●	●	●	●	●	()	●	Yes	Yes ¹
4	Dedar Karakorum	●	●	●	●	●	()	●		Yes
4	Dedar Karandash	●	●	●	●	●	()	●		Yes
4	Dedar Twist Again	()	()	●	()	()	()	()		(Yes)
4	Dedar Atlas		()	●	()	()	●	()		Yes
Leather										
1	CAMO Sierra (correct leather)	●	●	●			()	●	Yes	Yes + BS 5852 Crib 5
2	CAMO Sydney (semi aniline)	●	●	●			()	()	Yes	Yes
2	Sørensen Ultra	●	●	●			()	()	Yes	Yes
3	CAMO Silk (aniline)	●	●	●			()	●	Yes	Yes

For other fabrics please contact your local sales rep or Verpan HQ.
 () = not tested for the specific model - test can be performed on request
 (Yes) = Treatment is needed - after BS 5852 Part 1 + Crib 5 treatment is fulfilled
 Yes¹ = BS 5852 Part 1 is fulfilled - needs treatment to match BS 5852 Crib 5

PRODUCT OVERVIEW

Lighting.

FUN 2DM PENDANT

Verner Panton /1964

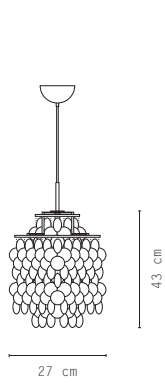

Frame options / Shells



Material

Seashell discs
 Chrome plated metal frame and canopy
 Stainless steel rings
 Black fabric cord

FUN 1DM PENDANT

Verner Panton /1964

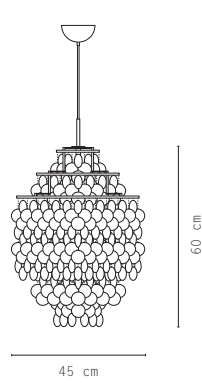

Frame options / Shells



Material

Seashell discs
 Chrome plated metal frame and canopy
 Stainless steel rings
 Black fabric cord

FUN 0DM PENDANT

Verner Panton /1964

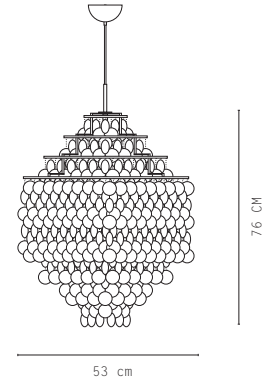

Frame options / Shells



Material

Seashell discs
 Chrome plated metal frame and canopy
 Stainless steel rings
 Black fabric cord

FUN 10DM PENDANT

Verner Panton /1964

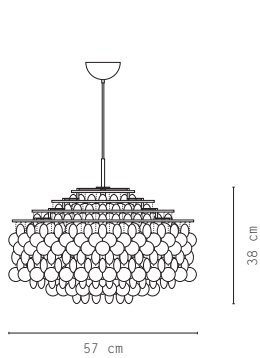

Frame options / Shells



Material

Seashell discs
 Chrome or brass plated metal frame and canopy
 Stainless steel rings
 Black fabric cord

FUN 11DM PENDANT

Verner Panton /1964

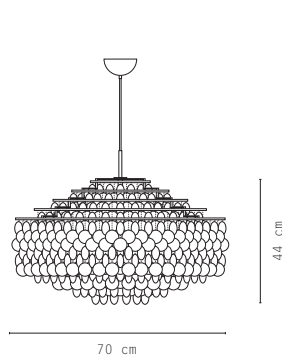

Frame options / Shells



Material

Seashell discs
 Chrome or brass plated metal frame and canopy
 Stainless steel rings
 Black fabric cord

VP GLOBE Ø40 PENDANT

Verner Panton /1969

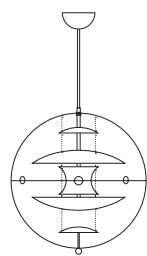

Ø40 cm

Variants



Material

Acrylic outer top and bottom shell
 Reflectors are suspended in steel chains
 Canopy made from chrome plated or painted metal
 Reflectors are available in brushed or painted aluminium, brass plated aluminium, opal glass, coloured glass.

VP GLOBE Ø50 PENDANT

Verner Panton /1969

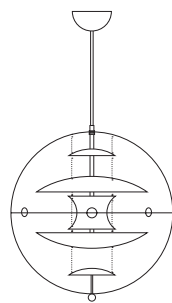

Ø50 cm

Variants

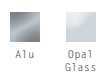

Material

Acrylic outer top and bottom shell
 Reflectors are suspended in steel chains
 Canopy made from chrome plated metal
 Reflectors are available in aluminium and opal glass.

PANTO Ø40 PENDANT

Verner Panton /1977

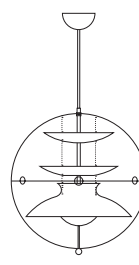

Ø40 cm

Variants



Material

Acrylic outer top and bottom shell
 Reflectors made from lacquered aluminium
 Reflectors are suspended in steel chains
 Canopy made from lacquered metal

PANTO Ø50 PENDANT

Verner Panton /1977

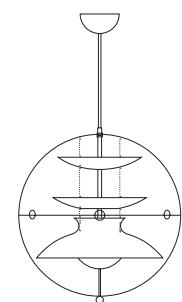

Ø50 cm

Variants



Material

Seashell discs
 Chrome or brass plated metal frame and canopy
 Stainless steel rings
 Black fabric cord

SPIRAL MINI PENDANT

Verner Panton /1969

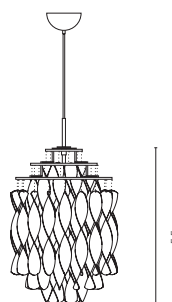

34 cm

55 cm

Frame options / Spiral Colours



Material

Cast ABS plastic spirals
 Small metal rings
 Ceiling canopy is made from chrome plated metal
 Black fabric cord

SPIRAL SP01 PENDANT

Verner Panton /1969

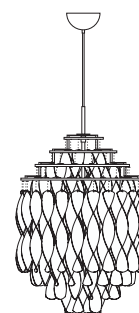

45 cm

60 cm

Frame options / Spiral Colours



Material

Cast ABS plastic spirals
 Small metal rings
 Ceiling canopy is made from chrome plated metal
 Black fabric cord

HIVE PENDANT

Verner Panton /1977

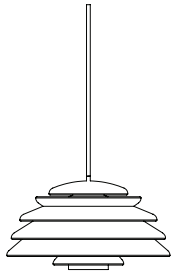

48 cm

Colours



Material

Aluminium shades
Polished aluminium (alu) or powder coated finish (yellow)
Canopy in same colour/finish as lamp.

MOON SMALL PENDANT

Verner Panton /1960



Ø34 cm

Colours



Material

Lamellae and canopy is made from lacquered metal

MOON LARGE PENDANT

Verner Panton /1960



Ø44,5 cm

Colours



Material

Lamellae and canopy is made from lacquered metal

PANTOP Ø23 PENDANT

Verner Panton /1980

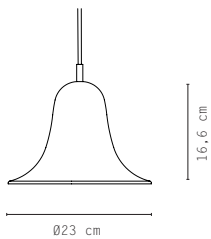

Colours

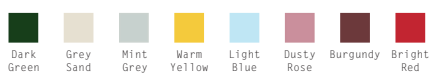

Material

Shade is made from metal
Black or white fabric cord

FUN 4DM XL PENDANT

Verner Panton /1964

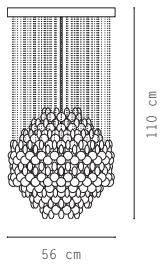

Canopy / Shells

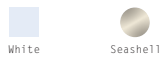

Material

Seashell discs
Stainless steel rings
Canopy is made from MDF
Transparent plastic cord

FUN 5DM XL PENDANT

Verner Panton /1964

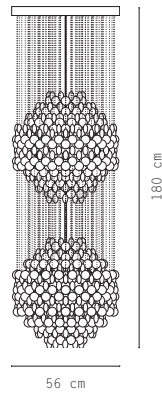

Canopy / Shells



Material

Seashell discs
Stainless steel rings
Canopy is made from MDF
Transparent plastic cord

FUN 3DM XL PENDANT

Verner Panton /1964

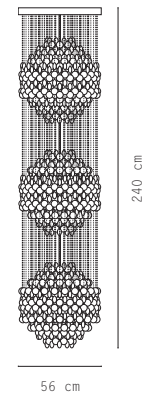

Canopy / Shells



Material

Seashell discs
Stainless steel rings
Canopy is made from MDF
Transparent plastic cord

FUN 7DM XL PENDANT

Verner Panton /1964

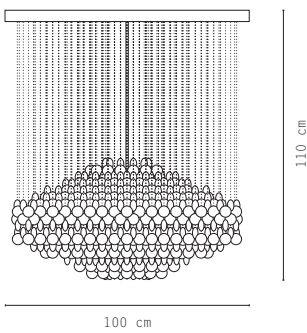

Canopy / Shells



Material

Seashell discs
Stainless steel rings
Canopy is made from MDF
Transparent plastic cord

FUN 8DM XL PENDANT

Verner Panton /1964

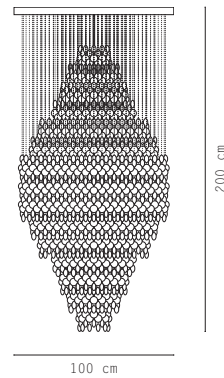

Canopy / Shells



Material

Seashell discs
Stainless steel rings
Canopy is made from MDF
Transparent plastic cord

MOON XL PENDANT

Verner Panton /1960

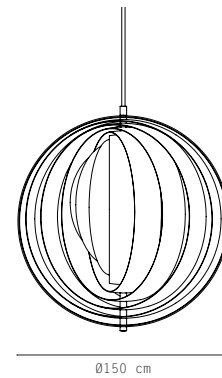

Colours



Material

Lamellae and canopy is made from lacquered metal

SPIRAL SP1 XL PENDANT

Verner Panton /1964

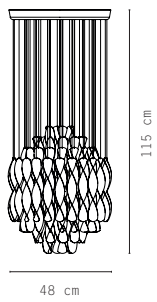

Canopy options / Spiral Colours



Material

Cast ABS plastic
Nylon string
Canopy is made from cast ABS plastic
Transparent plastic cord

SPIRAL SP2 XL PENDANT

Verner Panton /1964

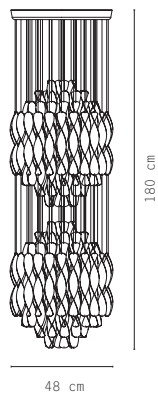

Canopy options / Spiral Colours



Material

Cast ABS plastic
Nylon string
Canopy is made from cast ABS plastic
Transparent plastic cord

SPIRAL SP3 XL PENDANT

Verner Panton /1964

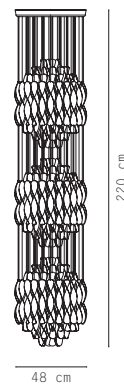

Canopy options / Spiral Colours



Material

Cast ABS plastic
Nylon string
Canopy is made from cast ABS plastic
Transparent plastic cord

FUN 2TM TABLE LAMP

Verner Panton /1964

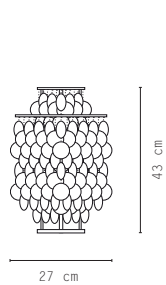

Frame options / Shells



Material

Seashell discs
 Chrome or brass plated metal frame and canopy
 Stainless steel rings
 Black fabric cord

FUN 1TM TABLE LAMP

Verner Panton /1964

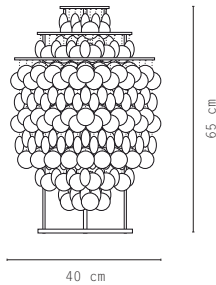

Frame options / Shells



Material

Seashell discs
 Chrome plated metal frame and canopy
 Stainless steel rings
 Black fabric cord

WIRE TABLE LAMP

Verner Panton /1972

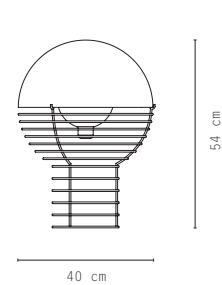

Frame options / Dome



Material

Chrome plated steel frame
 White plastic dome
 Clear PVC cord

REFLECT TABLE LAMP

Verner Panton /1980

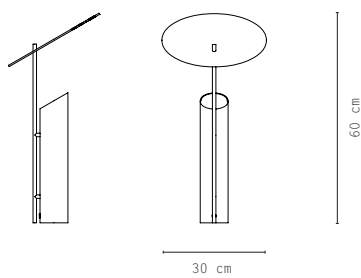

Colours



Material

All parts are made from steel
 Powder coated finish
 Vertical stem is finished in satin

PANTOP Ø23 TABLE LAMP

Verner Panton /1980

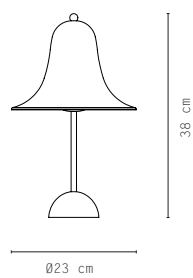

Colours

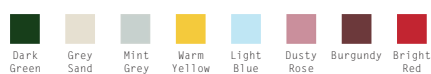

Material

Base, stem and shade is made from metal
 Chrome top bolt
 Clear PVC cord

PANTOP PORTABLE

Verner Panton /1980

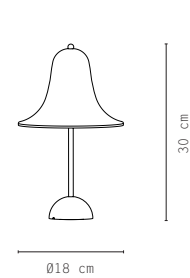

Colours

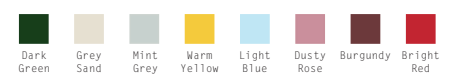

Material

Base, stem and shade is made from painted polycarbonate
 Dimmer/top bolt is made from brushed aluminium

FUN 1STM FLOOR LAMP

Verner Panton /1964

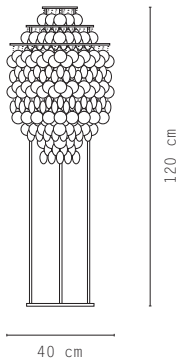

Frame options / Shells



Material

Seashells
 Chrome plated metal frame
 (silver or brass)
 Stainless steel rings
 Clear PVC cord

WIRE FLOOR LAMP

Verner Panton /1972

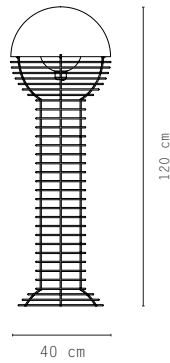

Frame options / Dome



Material

Chrome plated steel frame
 White plastic dome
 Clear PVC cord

FUN 1WM WALL LAMP

Verner Panton /1964

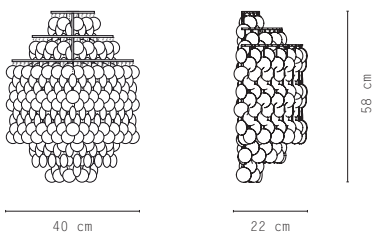

Frame options / Shells



Material

Seashell discs
 Chrome or brass plated metal frame
 Stainless steel rings
 Black fabric cord

SPIEGEL WALL LAMP

Verner Panton /1969

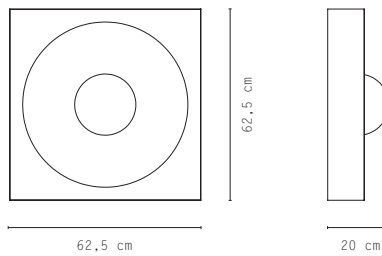

Colour



Material

Aluminium
 Black fabric cord

PRODUCT OVERVIEW

Accessories.

MIRROR SCULPTURE ONE

Verner Panton /1963

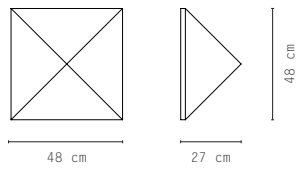

Colour



Material

3 mm (0.1") clear acrylic (PMMA)
Metal wall mounting bracket

MIRROR SCULPTURE FOUR

Verner Panton /1963

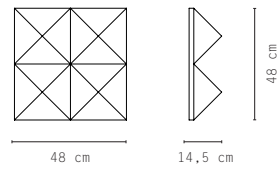

Colour



Material

3 mm (0.1") clear acrylic (PMMA)
Metal wall mounting bracket

MIRROR SCULPTURE NINE

Verner Panton /1963

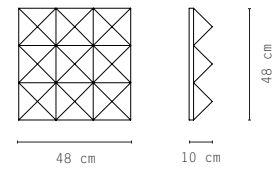

Colour



Material

3 mm (0.1") clear acrylic (PMMA)
Metal wall mounting bracket

MIRROR THROW

Verner Panton /1969

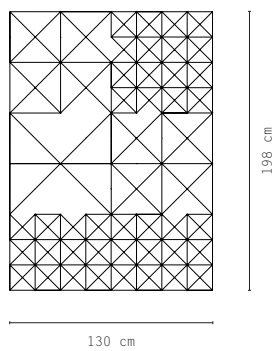

Colours

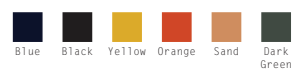

Material

100% New Zealand wool.

WAVE RUG

Verner Panton /1973

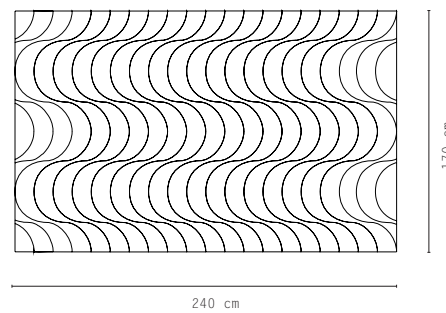

Colours



Material

100% New Zealand wool.

LUNA RUG

Verner Panton /1979

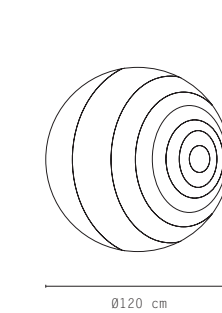

Colours

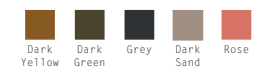

Material

100% New Zealand wool.



www.verpan.com