

FRITZ HANSEN



PLENUM™
PRODUCT FACT SHEET

PLENUM™

Plenum™ pays homage to the modern workspace – the perfect setting for collaboration, concentration or relaxation. Designed by Jamie Hayon, the curved high-back sofa system consists of one, two or three-seater units and features a range of added functionalities such as power plugs, USB ports and mounted or separate tables.

PRODUCT TYPE

Sofa and table

ENVIRONMENT

Indoor

DESIGNER / YEAR OF DESIGN

Jaime Hayon, 2018

DESIGNER

Spanish artist-designer Jaime Hayon was born in Madrid in 1974. As a teenager, he submerged himself in skateboard culture and graffiti art, the foundation of the detailed, bold yet whimsical imagery so imminent in his work today.

After studying industrial design in Madrid and Paris he joined Fabrica in 1997, the Benetton-funded design and communication academy, working closely with the legendary image-maker and agitator Oliverio Toscani. In a short time he was promoted from student to head of their Design Department. Eight years later, Jaime broke out on his own, first with his collections of designer toys, ceramics and furniture, later followed by interior design and installations.

MODELS

Sofa units:

JH1001: 1-seater

JH1002: 2-seater

JH1003: 3-seater

Table units:

JH70: Side sofa table (mounted to sofa unit, w. swivel)

JH75: Low table

JH80: High table

MATERIAL

Shell: Seat, back and side cushions are made of cut HR foam, to ensure durability and comfort. Screens and neck cushion are made of molded low emission HR MDI polyurethane foam with embedded steel or plywood support.

Tabletop: The tabletops come in light grey HPL laminate and consists of a 19 mm/0.7" particle board with a 1 mm/0.03" black ABS edge.

Base: The steel base for both sofa and table units is made of black powder coated steel. All bases are mounted with adjustable plastic gliders (PA).

Materials in %:

JH1001: Steel 40%, PUR 38%, Plywood 17%, Fabric 5%

JH1002: PUR 35%, Steel 33%, Plywood 25%, Fabric 7%

JH1003: PUR 35%, Steel 31%, Plywood 27%, Fabric 7%

JH70: HPL particleboard 49%, Steel 51% (without embedded standard base)

JH75: HPL particleboard 67%, Steel 33%

JH80: HPL particleboard 61%, Steel 39%

Items with a weight <1% of the total product weight are not included in the figures. The upholstery percentage may vary depending on the upholstery type.

FEATURES

- Power unit incl. USB ports (PU01)

UPHOLSTERY

The upholstery for Plenum™ is available in the following selection of textiles:

Canvas, Capture, Divina, Divina Melange, Divina MD, Fame, Fiord, Hallingdal, Messenger, Remix, Revive, Steelcut, Steelcut Trio, Tonus.

MADE-TO-ORDER

Non-standard configurations; special colours, upholstery (COM) etc., are available upon request at a minimum order quantity.

TEST

Plenum™ is created to stand the test of time and rigorous daily use in a wide variety of different environments – from a well-attended airport lounge to an open multifunctional office.

Sofa units:

- EN 16139 (EN 1728) Test Level 2 Severe Contract use for strength and durability
- EN 1022 for stability

Table units:

- EN 15372 (EN 1730) – Test level 3 Severe Contract use for strength and durability
- EN 1730 for stability

CERTIFICATION

To be announced.

For more information about environment and manufacturing processes, please visit fritzhanzen.com and download our environmental information sheet.

TECHNICALITIES

Power unit: Every version of the Plenum™ sofa units has the possibility of a clip-on power unit in black, which includes one regular plug and two USB (1,5A) ports; the power unit shall be mounted with two screws under the sofa. The power unit comes with a 3 m/118.1" power cord.

Side table: Can be mounted as a left or right side table, the table moves approx. 86°. The side table must be ordered together with a sofa unit and it is not interchangeable.

Upholstery: The upholstery can easily be replaced on the seat, back and side cushions exposed to most wear and tear.

Foam: Below is an overview of the foam used for the padding of the sofa units:

- A** Molded-foam, neck cushion (Soft)
- B** Cut foam back-cushions (soft)
- C** Molded foam, panels (Soft)
- D** Cut foam seat-cushions (firm)
- E** Wood, seat module

Steel base

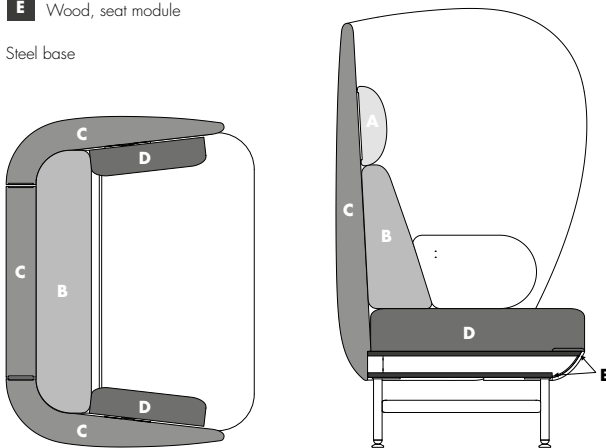

WEIGHT

Sofa units:
 JH1001: 63,0 kg / 138.9 lbs
 JH1002: 92,0 kg / 202.8 lbs
 JH1003: 120,0 kg / 264.6 lbs

Table units:
 JH75: 24,0 kg / 52.9 lbs
 JH80: 26,0 kg / 57.3 lbs

COUNTRY OF ORIGIN

Lithuania (production)
 Poland (distribution)

PRE-ASSEMBLED

No

The Plenum™ sofa units are delivered as “knock down” due to the size of the sofa. Therefore, the sofa is constructed to be assembled as easy and smooth as possible and with need of only two persons and a few tools. The modules are provided with pre-mounted metal threads to ensure durability and easy assembling/disassembling. Assembly guidelines will be included in the packaging.

PACKAGING

The units are covered with a recycled plastic bag and shipped in a recycled cardboard box. All packaging material can be recycled.

CLEANING AND CARE

Upholstery: Vacuum frequently on medium power. Remove wet stains by carefully dabbing with a lint-free cloth or sponge wrung in warm detergent-free water. If the stain remains, we recommend the chemical dry cleaning product K2R (www.k2rbrands.com). No other chemicals or detergents can be used. This also applies to steam cleaning.

NOTE! Do not rub the material with force. This could damage the fabric and cause loss of colour. No upholstered furniture should be exposed to direct sunlight or be placed close to a radiator or fireplace.

Laminate: Wipe the surface with a clean cloth wrung in a solution of hot water and a universal cleaning detergent.

Powder coated surfaces: Use warm water and wipe with a clean, soft cloth. Clean with dish detergent as the occasion requires.

NOTE! Do not use solvents on coated frames.

REPAIR, DISPOSAL AND REUSE

In case of repair and disposal the bases can be disassembled from the shell/tabletop. In case of disposal, bases can be sorted for recycling. Check local regulations for recycling options and whether there is potential for reuse. The back panels and armrests requires special handling due to the embedded steel frames - the armpads contain a small steel plate and the side panels contain small magnets.

WARRANTY

Fritz Hansen provides a five-year warranty on standard products against defects in materials and workmanship.

On any material, fabric and leather which is not listed as standard on a specific product the warranty is 2 years. Additional conditions can be found on fritzhanzen.com.

SPARE PARTS

Inquiries regarding spare parts can be sent to: salesupport@fritzhanzen.com

DIMENSIONS

JH1001:

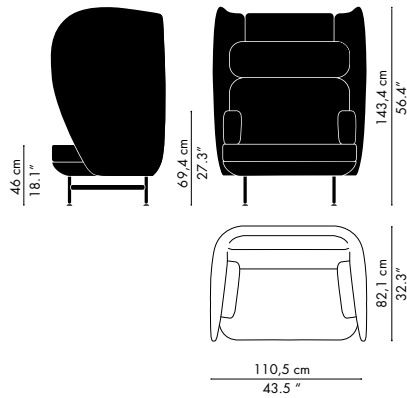

JH1002:

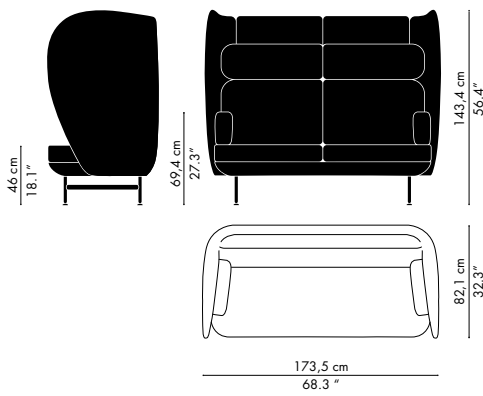

JH1003:

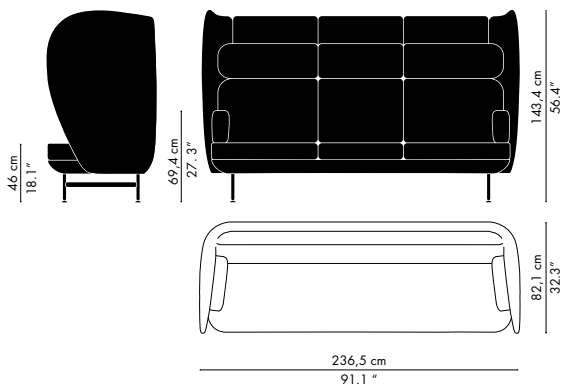

JH70:

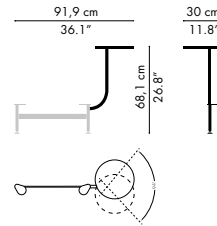

JH75:

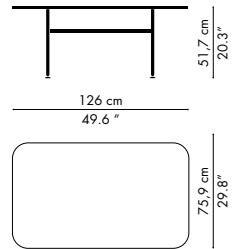

JH80:

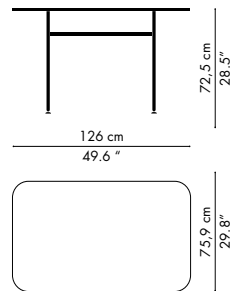

PU01:

