

karpeta

Collection Book

Introduction

Trame⁰¹⁸

Half Stripe	020
Indigo	024
(Un)fold	028
Checkers	034
China	038
Treccia	044
Pile	048
Checkmate	054
Tuo	058
Savanna B	062
Lino Circle	066
Rubber Tube	072
Net	076
Oasis 1.2	080
Oasis 2	084
Moq	088

Raw⁰⁹⁴

Magneto	096
Mosaico	100
Acapo	106
Blanco	110
Rubia	116
Pompon	120
Haiti	126
Kleos	130
Kura	134
Meknès	138
Zullayj	142

Printed¹⁴⁶

Torrente	148
----------	-----

Nodi¹⁵⁴

Friendly	156
Sliding	162
Le ragazze	168
Psychedelic flower	172
Antique Rose and Black	176
Esodo	182
Tintas	186

Technical Info¹⁹²

IT — Ci ha sempre affascinato la sapienza che permette di trasformare filati in tappeti, l'ispirazione che trasforma bozzetti in opere d'arte, la creatività che trasforma il design in esperienza estetica. Viaggiatori per passioni, abbiamo percorso a ritroso le strade delle antiche carovane, con l'ambizione di scoprire mondi e ibridare culture. Karpeta è la nostra tela imprenditoriale, che giorno dopo giorno, rendiamo più solida e affascinante, annodando con pazienza tradizione e modernità, arte e design, per creare un manufatto unico.”

EN — We've always been fascinated by the knowledge behind rug weaving, by the inspiration that allows to create a piece of art out of a sketch, by the creativity able to transform design into an aesthetic experience. We share the same passion for traveling, we have traveled along the ancient caravan roads to discover different worlds and experience a combination of different cultures. Karpeta is our personal business canvas, and day by day we are making it stronger and more fascinating, by patiently knotting tradition and modern, art and design, to create a unique product.







IT — Arrivata alla settima collezione, l'azienda nata dalla visione e dal progetto degli imprenditori Daniele Morabito e Simona Scollica conferma il percorso di ibridazione fra culture e mondi che trasforma il tappeto in una storia di storie, in grado di trasformare lo spazio e riscrivere il tempo. Sintesi della millenaria tradizione tessile e indiana e delle più innovative ispirazioni nazionali e internazionali, le creazioni Karpeta sono prodotte a mano secondo i più rigorosi canoni dell'antica tradizione artigiana, ma proiettate verso futuri possibili e mondi plausibili dall'estro di una squadra di designer che si rinnova ogni anno e affianca i creativi dell'azienda. Visioni destinate a rinnovarsi nel presente di chi deciderà di sperimentarle, introducendo nel proprio quotidiano tappeti che ambiscono ad essere trama d'arte, che nel presente si perpetua e si rinnova.

EN — Founded by Daniele Morabito and Simona Scollica, Karpeta introduces its 7th collection, a brand new world of weaves, knots and prints embracing the original vision of the two founders: combining different cultures and worlds capable of turning each rug into a tale of tales, reinterpreting time and space. Handmade according to the ancient artisanal techniques, and yet created to reflect possible futuristic worlds, the creations by Karpeta combine India's thousand year old weaving tradition with the innovative talent of a team of national and international designers, renovated every year, working alongside the brand's creative team. The rugs by Karpeta deliver new, artistic visions destined to change the everyday life of those who will experience them.

IT — Espressione fedele delle visioni e dei progetti più innovativi dei designer Valentina Cameranesi, Rosemarie Auberson, José Mendoza, Stefania Crippa Lio De Bruin, Giulia Ferraris, Elsa Boch & Ferréol Babin e le matite di Studiocharlie & Silvia Destito, New Friends, Studio Tomorrow, Studio Testo, Casalinghe di Tokyo, BCXSY, i tappeti Karpeta sono realizzati interamente a mano secondo le più antiche tecniche di tessitura. Ogni manufatto è frutto di lavorazioni artigianali l'annodatura e la taftatura manuale, l'intreccio di trama e ordito attraverso telaio verticale a mano, la stampa hand made, il kilim realizzate in India. Il team di progettazione Karpeta segue passo passo la realizzazione di ciascun manufatto, permettendo a chi li sceglie la massima possibilità di personalizzazione dei tappeti, volano di un'esperienza estetica che vuole essere custom made.

EN — Loyal expression of the innovative visions and projects of designers Valentina Cameranesi, Rosemarie Auberson, José Mendoza, Stefania Crippa, Lio De Bruin, Giulia Ferraris, Elsa Boch & Ferréol Babin and Studiocharlie & Silvia Destito, New Friends, Studio Tomorrow, Studio Testo, Casalinghe di Tokyo, BCXSY, the rugs by Karpeta are entirely handmade according to the ancient weaving techniques. Each product is the result of artisanal work handknotted and handtufted, vertical hand loom weaving, handmade printing, kilim made in India. The project team Karpeta oversees the entire production of each rug, allowing the clients to personalize the products chosen and therefore delivering a custom made experience.







BCXSY

Lino Circle



Casalinghe di Tokyo

Esodo



Stefania Crippa

Rubia
Indigo



Lio de Bruin

Pompon
Pile



New Friends

Half Stripe



Rosemarie Auberson

Antique Rose and Black



Elsa Boch&Ferréol Babin

Magneto



Giulia Ferraris

Mosaico
Acapo



Elisa Polimeni

Kleos



Studiocharlie & Silvia Destito

Torrente



Studio Testò

Blanco



Studio Tomorrow

(Un)fold



Ilaria Innocenti

Net



José Mendoza

Tintas



Valentina Cameranesi

China
Treccia
Le Ragazze
Psychedelic flower



Diversi nel linguaggio, unici nello spirito, i tappeti della collezione Karpeta sono prodotti unici, voluta espressione della contaminazione di culture, che dalle vie delle carovane è passata alle reti informatiche. —

Different style, same soul, the rugs of the Karpeta's collection are unique creations, appositely created to combine the different cultures from the caravan road to the actual computer networks.

Trame

Contrasti decisi, reticolati ipnotici, inaspettati tromp l'oeil, colori netti sono l'alfabeto della collezione "Trame" che del tappeto tessuto a mano vuole essere nuova letteratura, ispirata da designer come Stefania Crippa, New Friends, Lio De Bruin, Studio Tomorrow e Valentina Cameranesi. —

The collection "Trame" features strong contrasts, hypnotic mesh patterns, unexpected tromp l'oeil, neat colors, setting the new standards for handmade rugs, inspired by talented designers such as Stefania Crippa, New Friends, Lio De Bruin, Studio Tomorrow and Valentina Cameranesi.

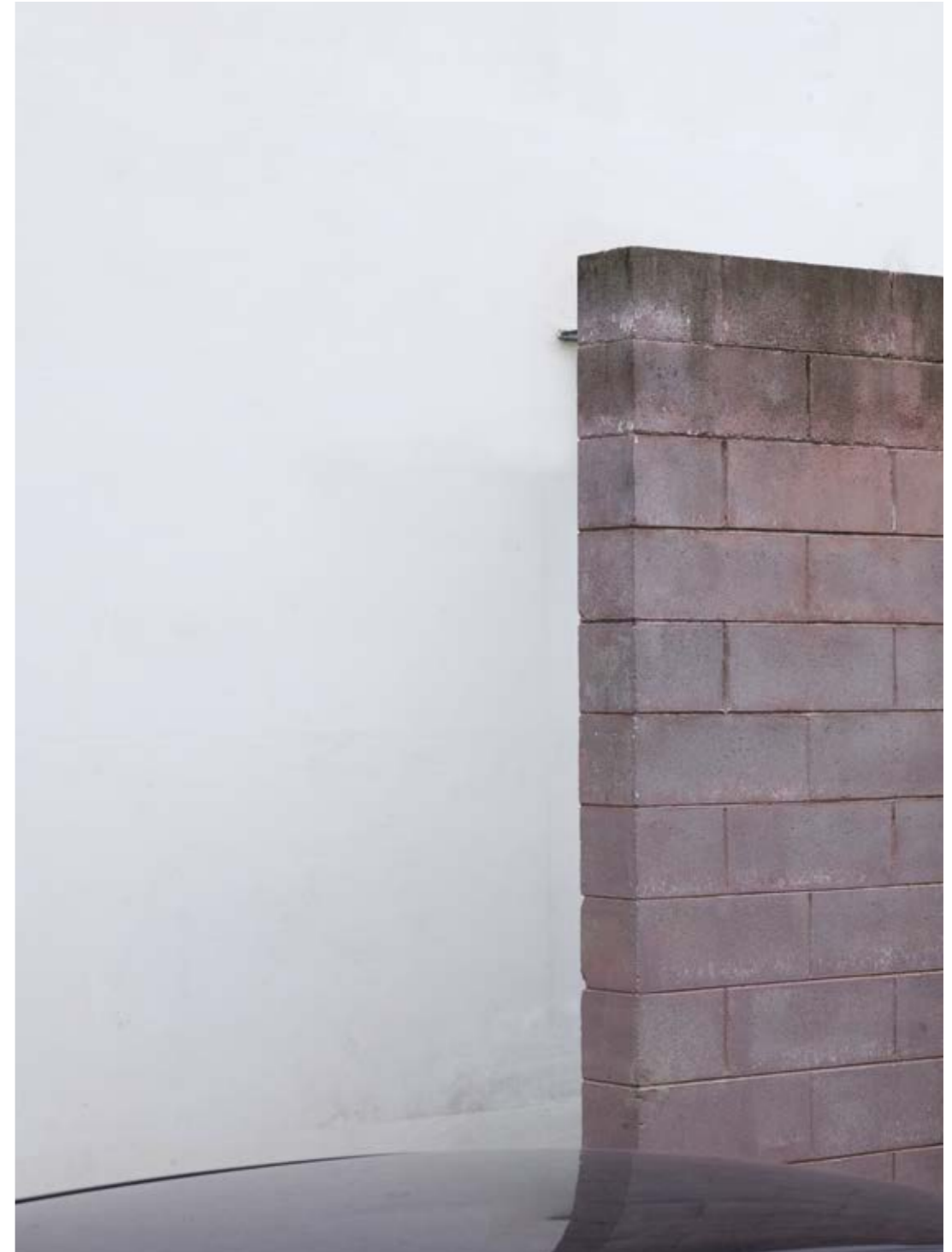

Half Stripe

IT — Questo disegno di tappeto è ispirato a una serie di pezzi di muri tessuti in cui i plaid e le strisce contrastanti a stretta larghezza sono abbinati insieme per creare composizioni grafiche. Queste composizioni riguardano le tradizionali tecniche di tessitura a strisce dell'Africa occidentale e l'espressionismo astratto minimalista.

EN — This rug design is based on a series of woven wall pieces in which narrow- width contrasting plaids and stripes are paired together to create graphic compositions. These compositions reference traditional West African strip weaving techniques as well as minimalist abstract expressionism.

Designer: New Friends

Technique: Handloom

Dimension: 170 x 240 - 200 x 300 cm

Special dimension available on request

Composed: 90% Wool + 10% Cotton

Weight: 2,5 Kg mq

Technical Info: page 194



New Friends



Indigo

IT — Indigo si ispira agli antichi Kasuri giapponesi e alle geometrie tribali dell'arte africana.

Tappeto dal fascino antico, come il nome che porta, colorazioni naturali dai toni morbidi e vibranti.

La base viene ricamata con tecniche sperimentali cucendo cordoncini con colori a contrasto. Questa lavorazione contribuisce a esaltare la profondità cromatica e il sapore artigianale del manufatto.

EN — Indigo is inspired by Japanese ancient Kasuri and by African tribal art geometries. Rugs sharing with their names the same ancient charm, natural colors featuring soft, vibrant shades. We used experimental techniques for our embroidered rugs. This method exalts the product's color depth and artisanal charm.

Designer: Stefania Crippa – *Studio Contromano*

Technique: Handwoven

Dimension: 170 x 240 – 200 x 300 cm

Special dimension available on request

Composed: 70% Wool + 20% Linen + 10% Cotton

Weight: 2,3 Kg mq

Technical Info: page 194



Stefania Crippa
Studio Contromano



(Un)fold

IT — La tecnica della piegatura è normalmente usata nella moda per costruire sagome o creare una bellezza in movimento. Adoriamo questo modo estetico di creare texture. Merita attenzione e dedizione per essere eseguito nel modo giusto. Questa tecnica di moda tradotta in un prodotto interno, aggiunge un senso di movimento in una stanza. Abbiamo combinato filati che hanno una differenza di lucentezza e hanno costruito le pieghe in più direzioni. Questa combinazione di luce diurna sempre mutevole insieme al punto di vista degli osservatori, ci consente di sperimentare il tappeto seguendo vie tra loro molto diverse.

EN — The technique of pleating is normally used within fashion to construct silhouettes or create a beauty in movement. We love this aesthetic way of creating texture. It deserves focus and dedication to be executed in the right way. This fashion technique translated in to an interior product, adds a sense of movement to a room. We combined yarns that have a difference in luster and constructed the pleats in multiple directions. This combination of ever changing daylight together with the beholders point of view, makes that we're experiencing the carpets in multiple different ways.

Designer: Studio Tomorrow

Technique: Handwoven

Dimension: 170 x 240 - 200 x 300 cm

Special dimension available on request

Composed: 10% New Zealand Wool +

20% Bamboo Silk + 70% Jute

Weight: 2,5 Kg mq

Technical Info: page 195



Studio Tomorrow

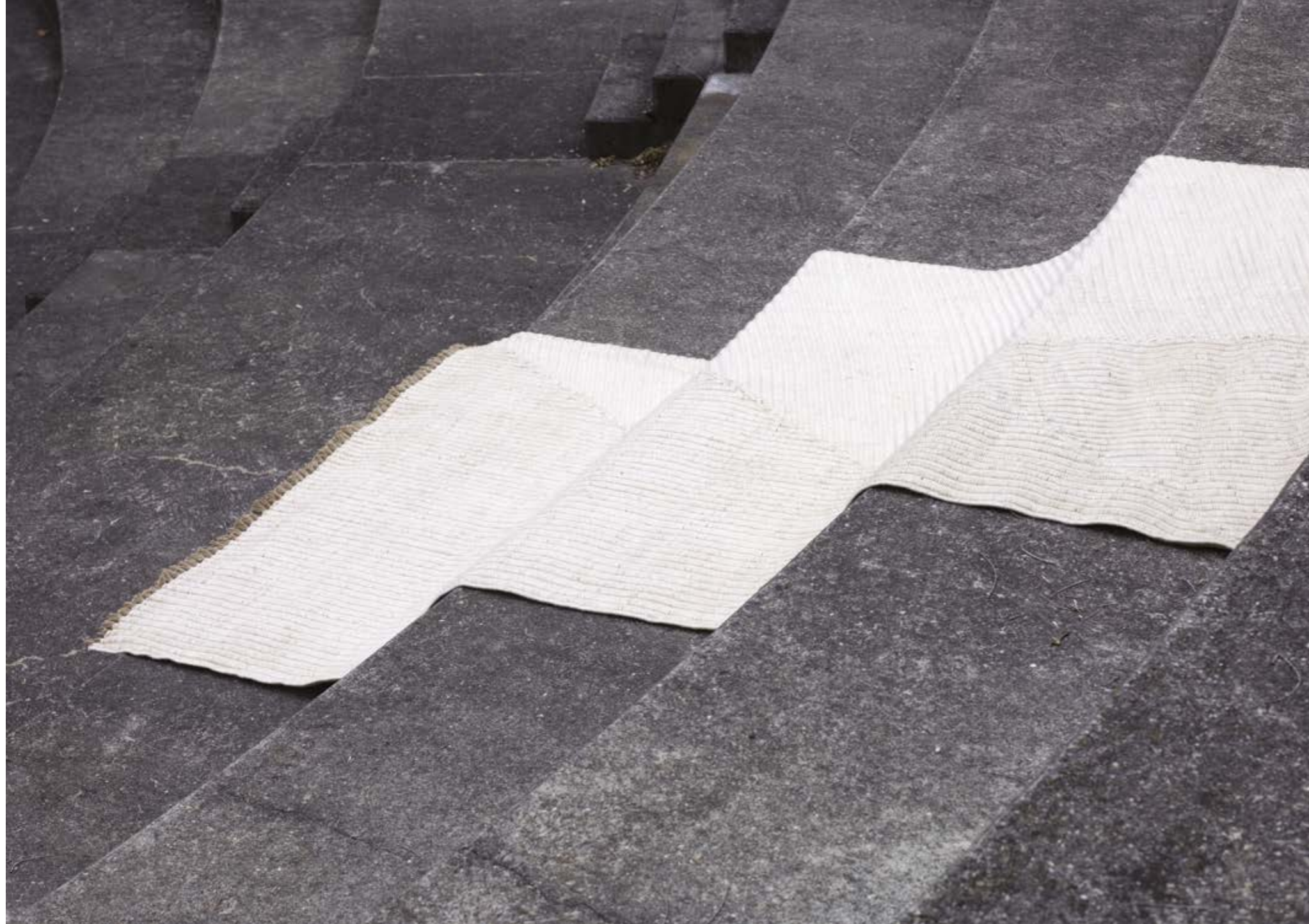



Checkers

IT — Ispirato all'antico gioco degli scacchi troviamo linee a rappresentare le armate e superficie a scacchiera quale campo di azione simbolo dell'esistenza.

EN — Inspired by the ancient game of chess, the lines here represent the armies and the chess board surface, like a field of action symbol of our existence.

Designer: Karpeta Team
Technique: Handwoven
Dimension: 170 x 240 - 200 x 300 cm
Special dimension available on request
Composed: 90% Wool + 10% Cotton
Weight: 2,5 Kg mq
Technical Info: page 195

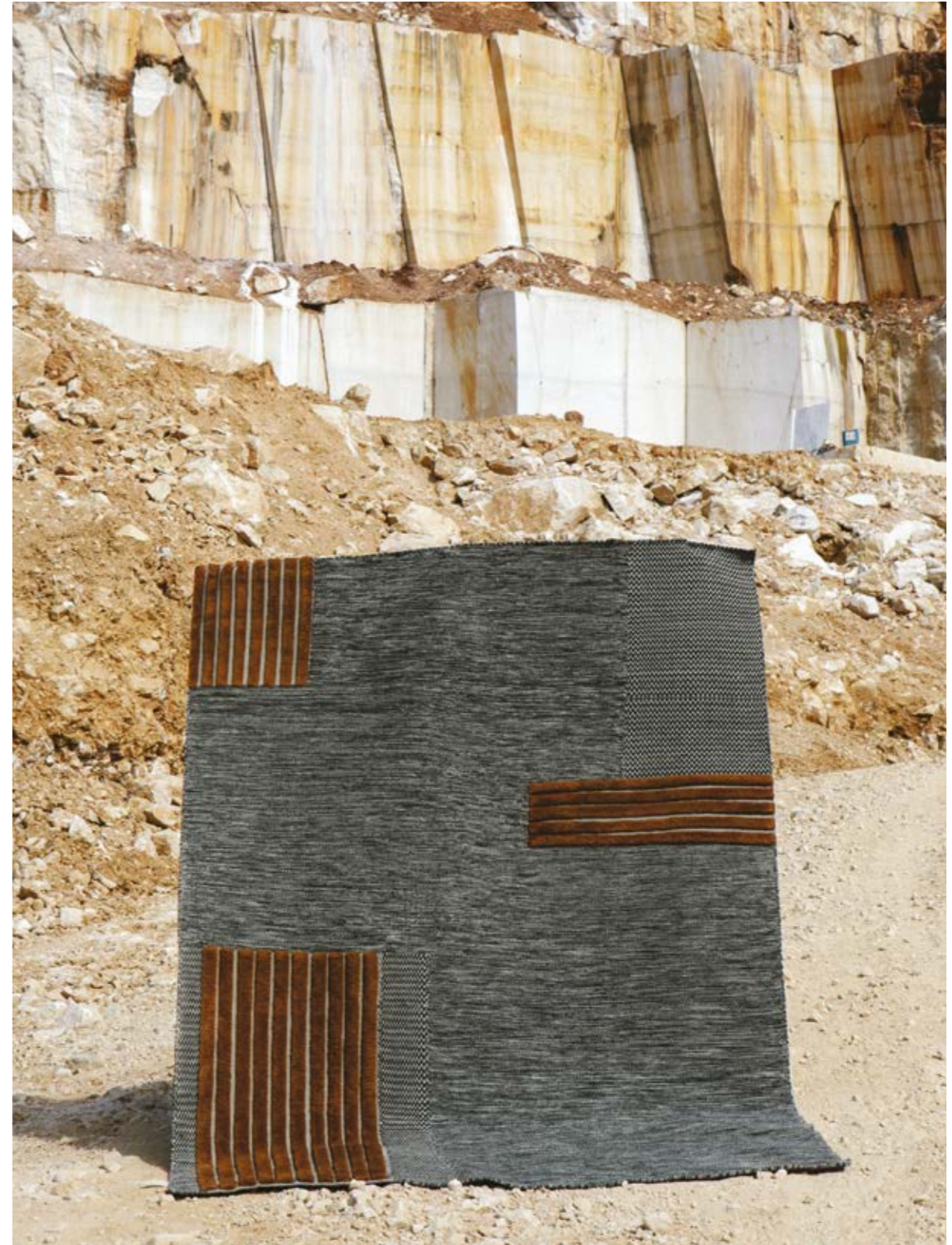



China

IT — Una sorta di trompe l'oeil minimo dove le geometrie spezzano il pattern delicato come un segno di china su un foglio.

EN — A sort of minimal trompe l'oeil where the geometries break the gentle pattern like the indian ink marks the paper.

Designer: Valentina Cameranesi
Technique: Handwoven
Dimension: 170 x 240 - 200 x 300 cm
Special dimension available on request
Composed: 60% Wool + 30% Jute + 10% Cotton
Weight: 1,5 Kg mq
Technical Info: page 196



Valentina Cameranesi



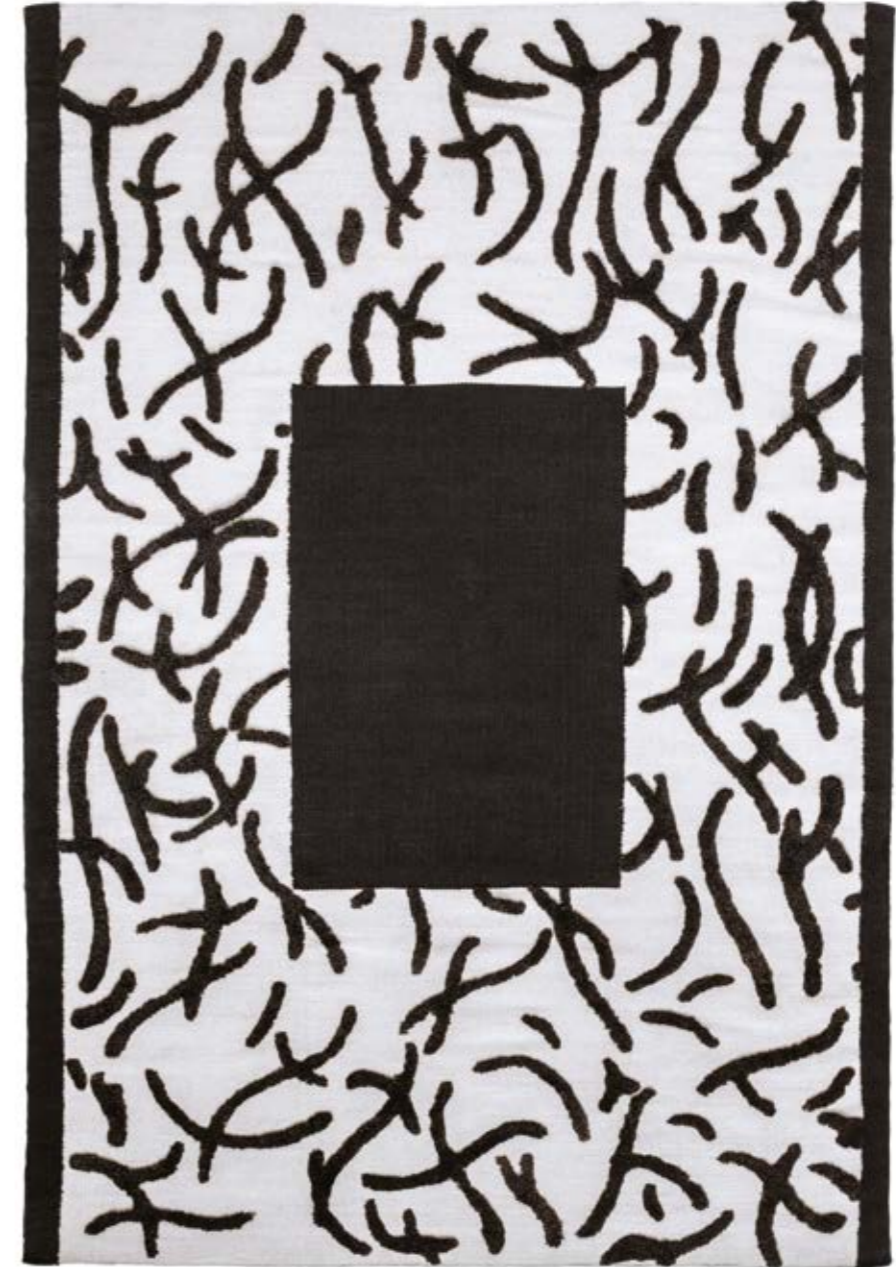

Treccia

IT — Un close up di una treccia, l'idea dell'intreccio base stessa del tappeto enfatizzato e ricreato come decoro.

EN — Close-up of a braid, the concept of braiding is the base itself of the rug, emphasized and recreated to be an element of decor.

Designer: Valentina Cameranesi
Technique: Soumak Overtuft
Dimension: 170 x 240 - 200 x 300 cm
Special dimension available on request
Composed: 50% Jute + 40% Bamboo Silk + 10% Cotton
Weight: 3,25 Kg mq
Technical Info: page 196



Valentina Cameranesi

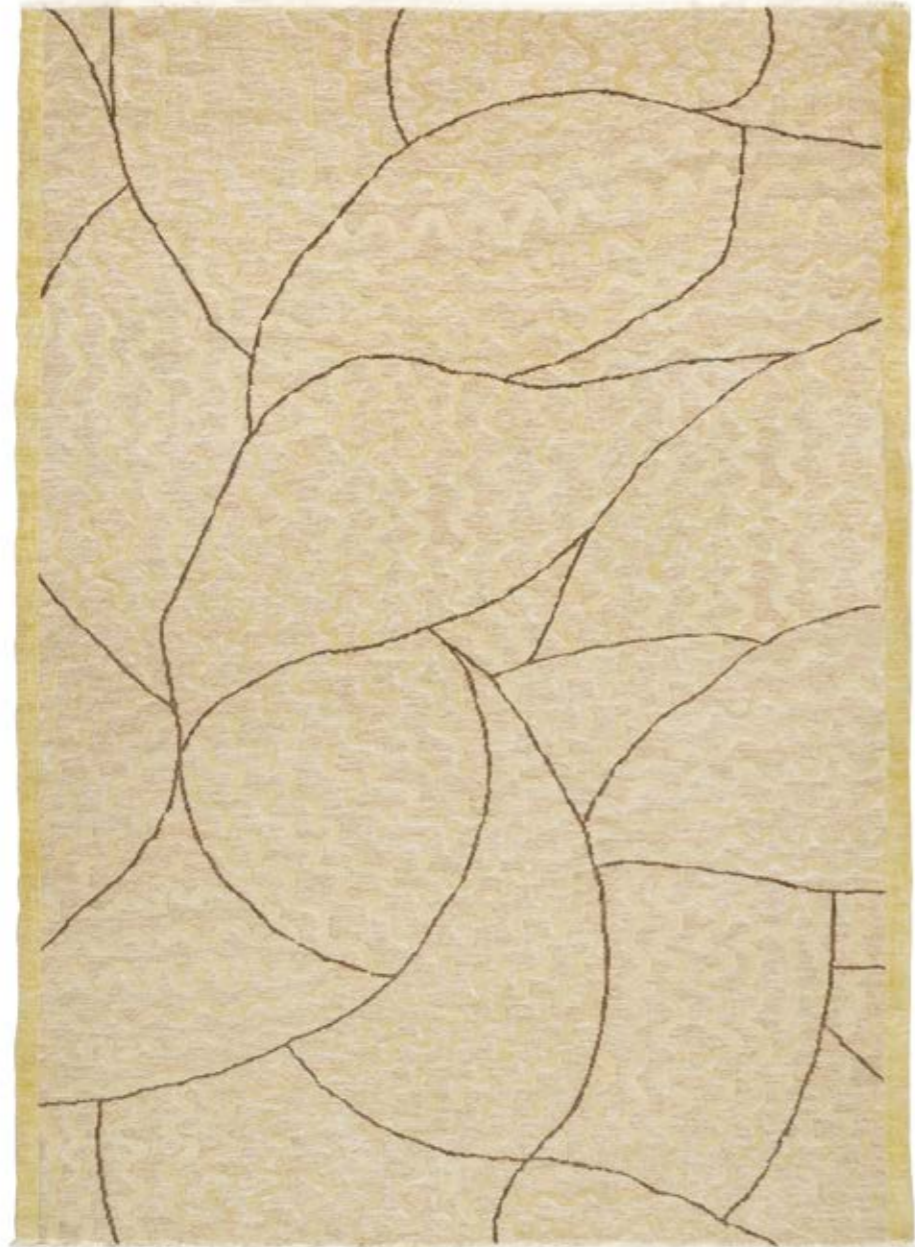

Pile

IT — Questo tappeto tessuto a mano è frutto dell'interazione di quattro diverse tecniche di tessitura. I due colori contrastanti creano un risultato grafico giocoso e sottile.

EN — This handwoven carpet is rich in structures because of the interplay of four simple different weaves. The two contrasting colours creates a playful and subtle graphic outcome.



Lio de Bruin



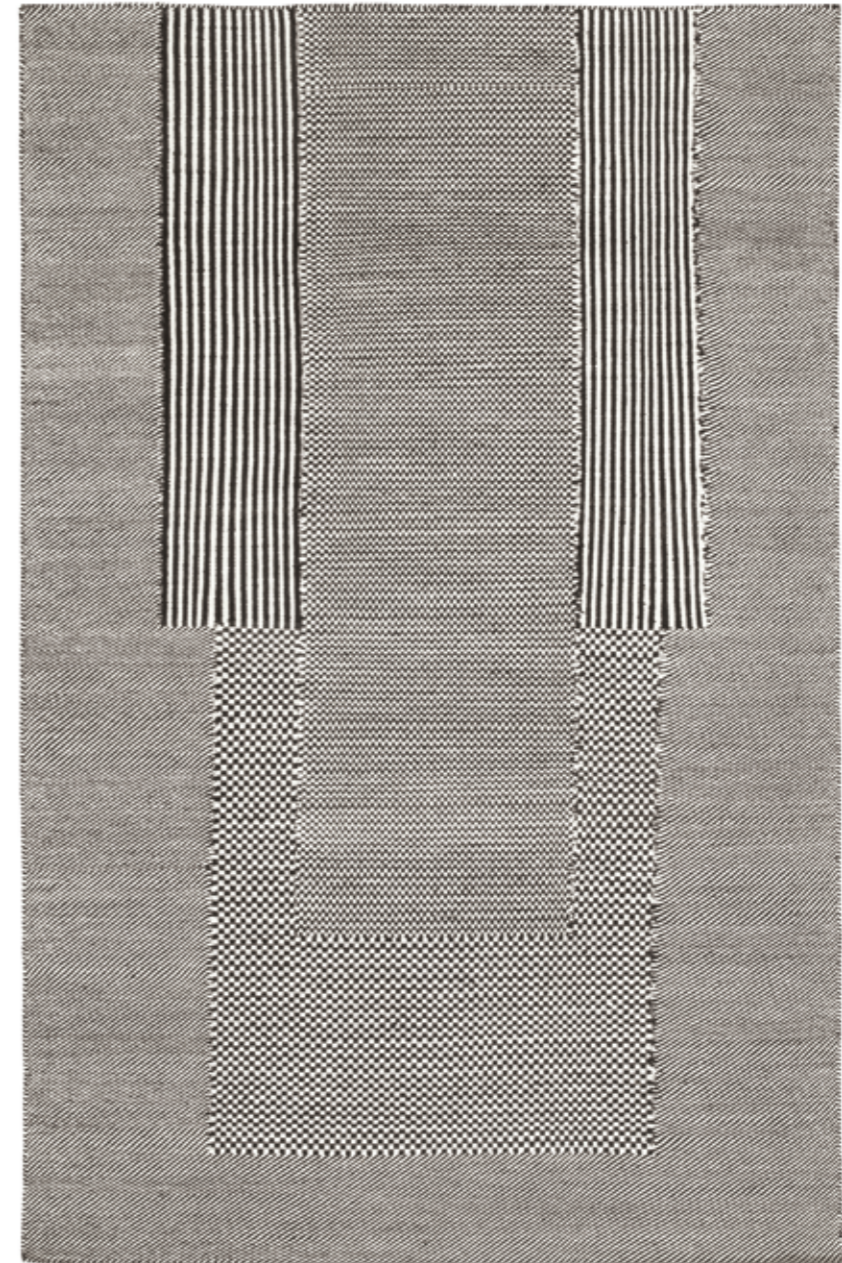

Designer: Lio de Bruin
Technique: Handwoven
Dimension: 170 x 240 - 200 x 300 cm
Composed: 90% Wool + 10% Cotton
Weight: 1,8 Kg mq
Technical Info: page 197

Checkmate

IT — La lana incontra la juta in un contrasto di superfici che al tatto raccontano come morbido - raffinato e ruvido - grezzo possano creare effetti sorprendenti e mosse da scaccomatto.

EN — Wool and jute match to create soft - fine and rough surfaces in contrast for a surprising, checkmate like effect.

Designer: Karpeta Team

Technique: Handwoven

Dimension: 170 x 240 - 200 x 300 cm

Special dimension available on request

Composed: 45% Wool + 45% Jute + 10% Cotton

Weight: 1,8 Kg mq

Technical Info: page 197

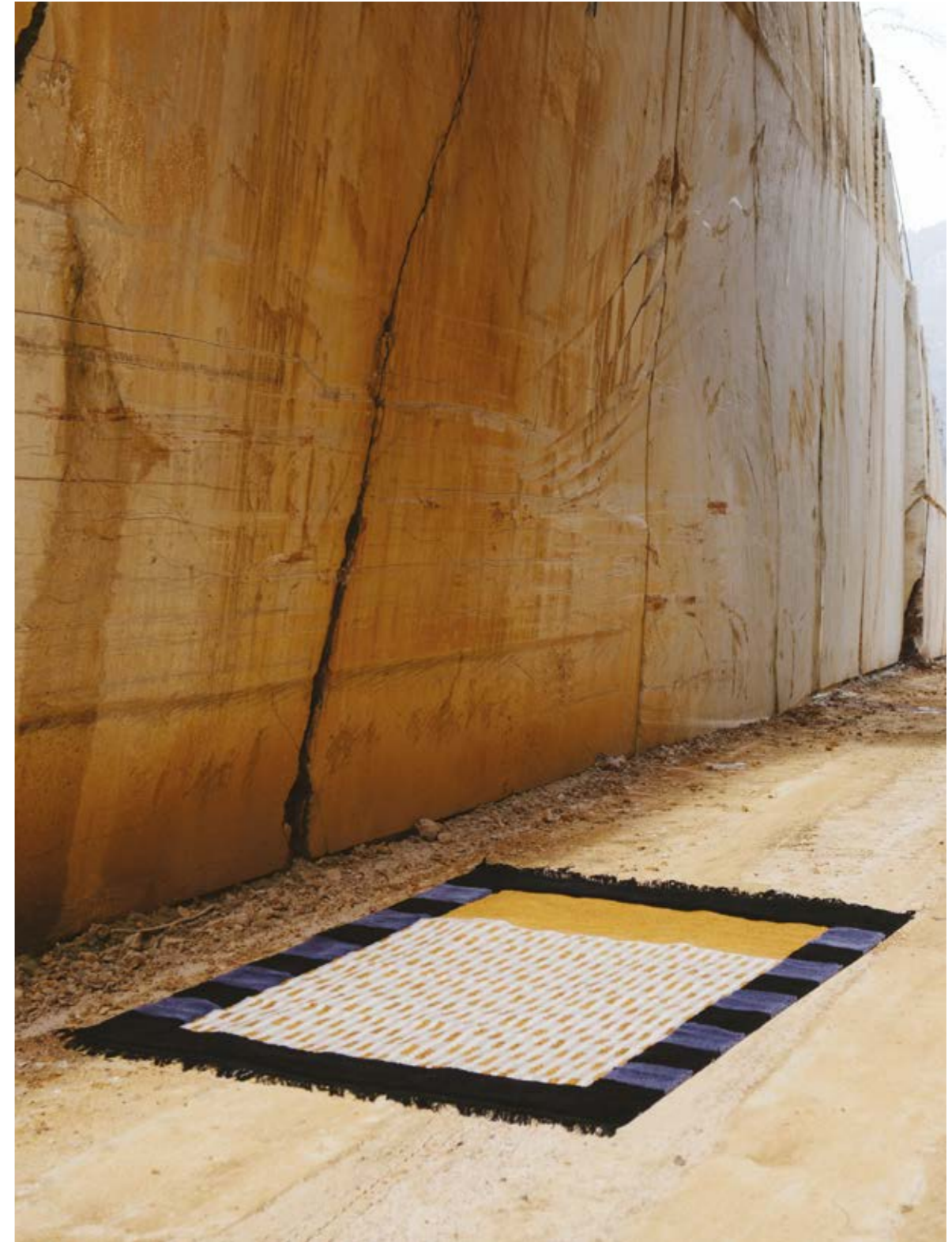



Tuo

IT — Densità, colore, fili di lana e juta in trama battuti insieme e poi sagomati dalle sapienti mani artigiane a creare effetti di altezze e sensazioni tattili contrastanti.

EN — Consistency, color, wool and jute threads knotted and shaped by the wise hands of artisans, creating effects of heights and tactile feelings in contrast.

Designer: Karpeta Team

Technique: Handwoven

Dimension: 170 x 240 - 200 x 300 cm

Special dimension available on request

Composed: 45% Wool + 45% Jute + 10% Cotton

Weight: 3,4 Kg mq

Technical Info: page 195



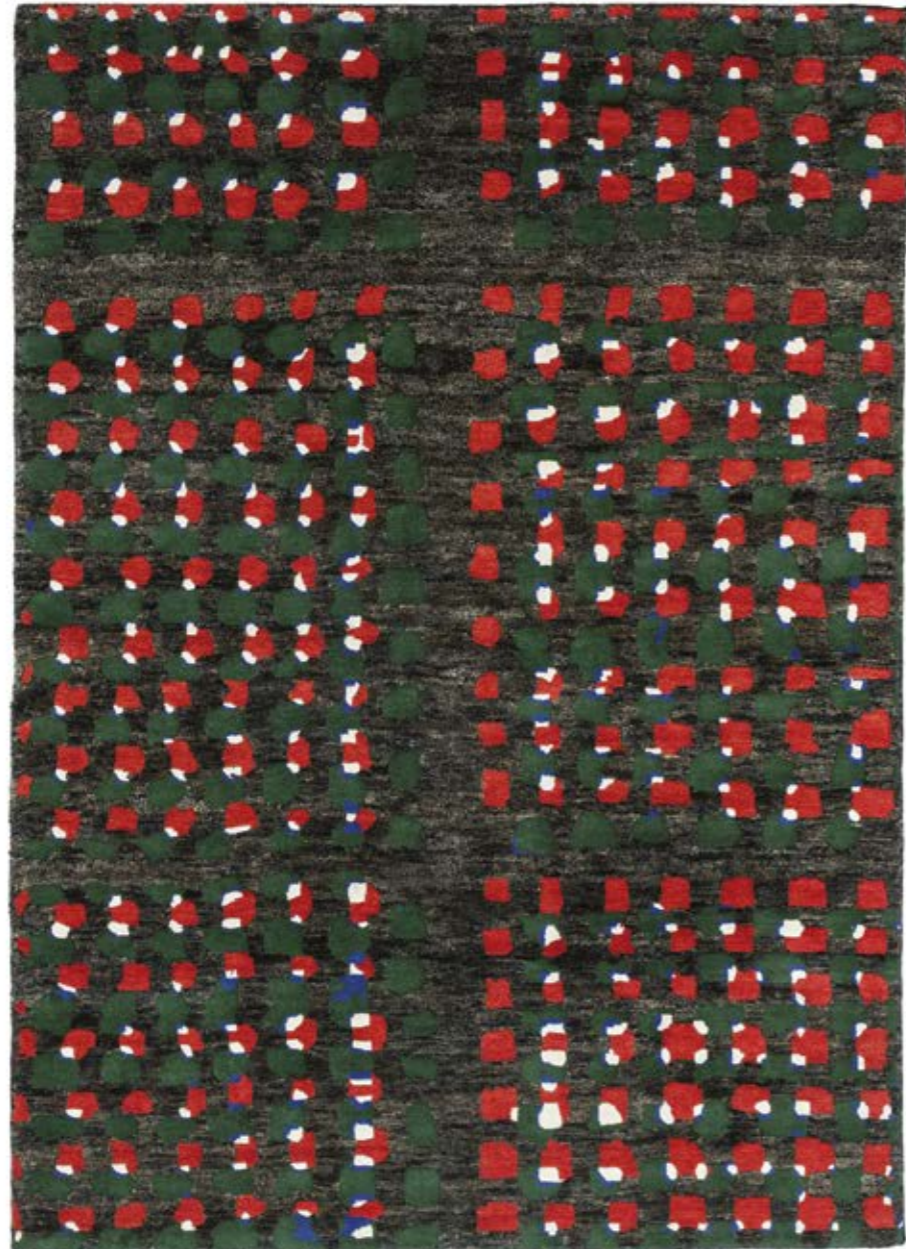

Savanna B

IT — Brillante tencel per un tappeto dall'ineguagliabile morbidezza. Necessita una delicata manutenzione.

EN — Shiny tencel for a carpet of incomparable softness. Gentle care necessary.





Designer: Karpeta Team
Technique: Handwoven
Dimension: 170 x 240 - 200 x 300 cm
Special dimension available on request
Composed: 90% Tencel + 10% Cotton
Weight: 5,5 Kg mq
Technical Info: page 201

Lino Circle

IT — Un tappeto modulare, costituito da due pezzi sovrapposti. I tappeti potrebbero essere usati singolarmente, fianco a fianco o inserendo il tappeto lungo le due fessure su entrambe le estremità.

EN — A modular carpet, consisting of two overlapping pieces. The carpets could be used individually, side by side, or by inserting the long carpet into the two slits on both ends.

Designer: BCXSY

Technique: Hand Tufted and Handwoven

Dimension: 170 x 240 + 85 x 280

200 x 300 + 100 x 340 cm

Special dimension available on request

Composed: 40% Wool + 30% Jute +

20% Linen + 10% Cotton

Weight: 5 Kg mq

Technical Info: page 198



BCXSY

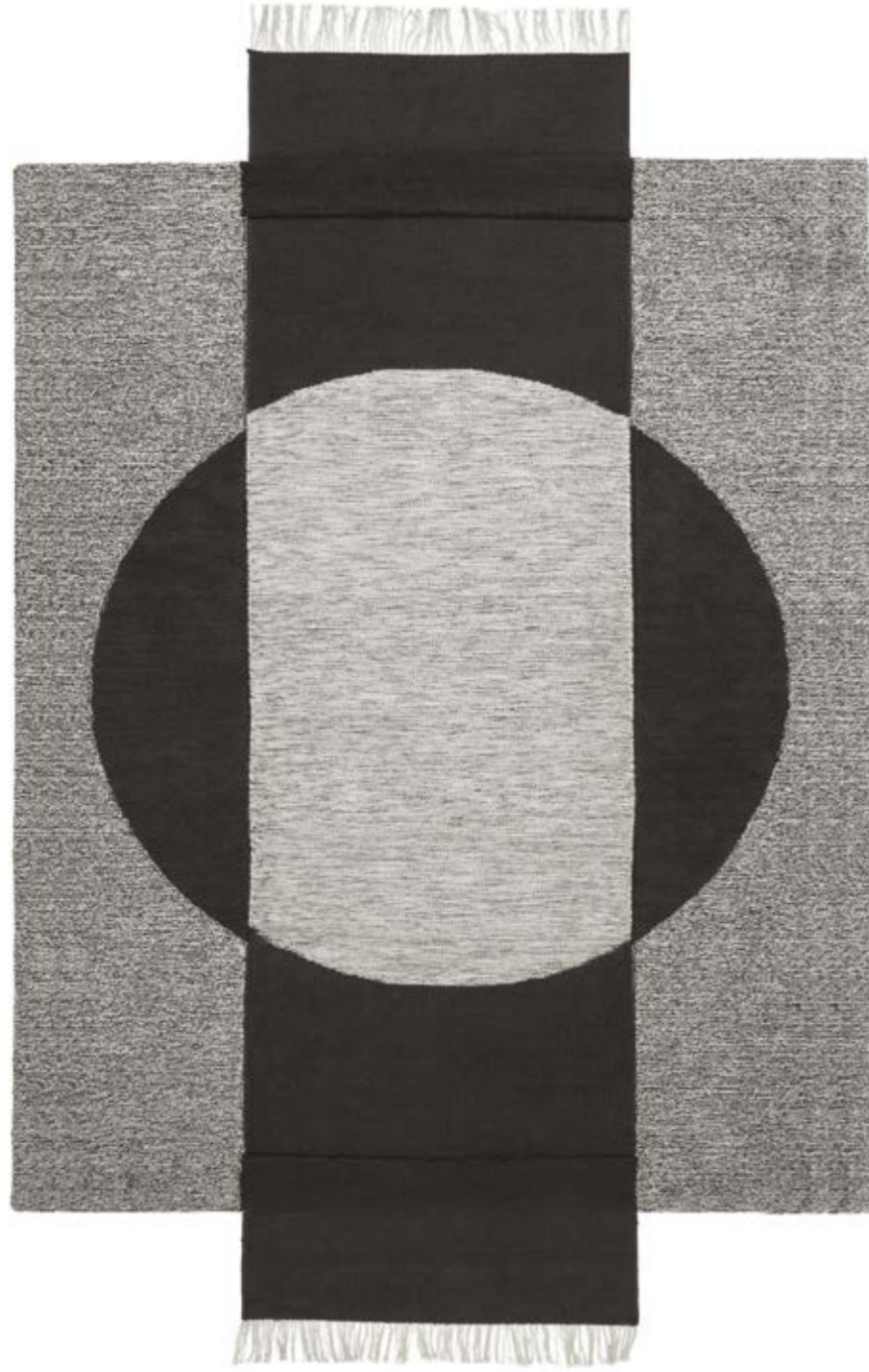



Rubber Tube

IT — Dalle camere d'aria di bicicletta otteniamo un tappeto impermeabile outdoor/indoor pratico e leggero.

EN — From bicycle tires we achieve a waterproof carpet for outdoor and indoor use that is practical and light.





Designer: Karpeta Team

Technique: Handwoven

Dimension: 170 x 240 - 200 x 300 cm

Special dimension available on request

Composed: 70% Polyester 30% Rubber

Weight: 3,5 Kg mq

Technical Info: page 201

Net

IT — Motivi a contrasto e disegni sfumati per un effetto ottenuto dalla annodatura della lana con filo di cotone, dalla tintura con alternanza di colori chiari e scuri. La magia dell'effetto finale a sorpresa è sempre garantita.

EN — Contrasting patterns and blending designs an effect obtained by knotting wool with a cotton thread and dyeing with alternate light and dark colours. The magical result is always a surprise.

Designer: Ilaria Innocenti

Technique: Handwoven

Dimension: 170 x 240 - 200 x 300 cm

Special dimension available on request

Composed: 90% New Zeland Wool + 10% Cotton

Weight: 3,2 Kg mq

Technical Info: page 199



Ilaria Innocenti

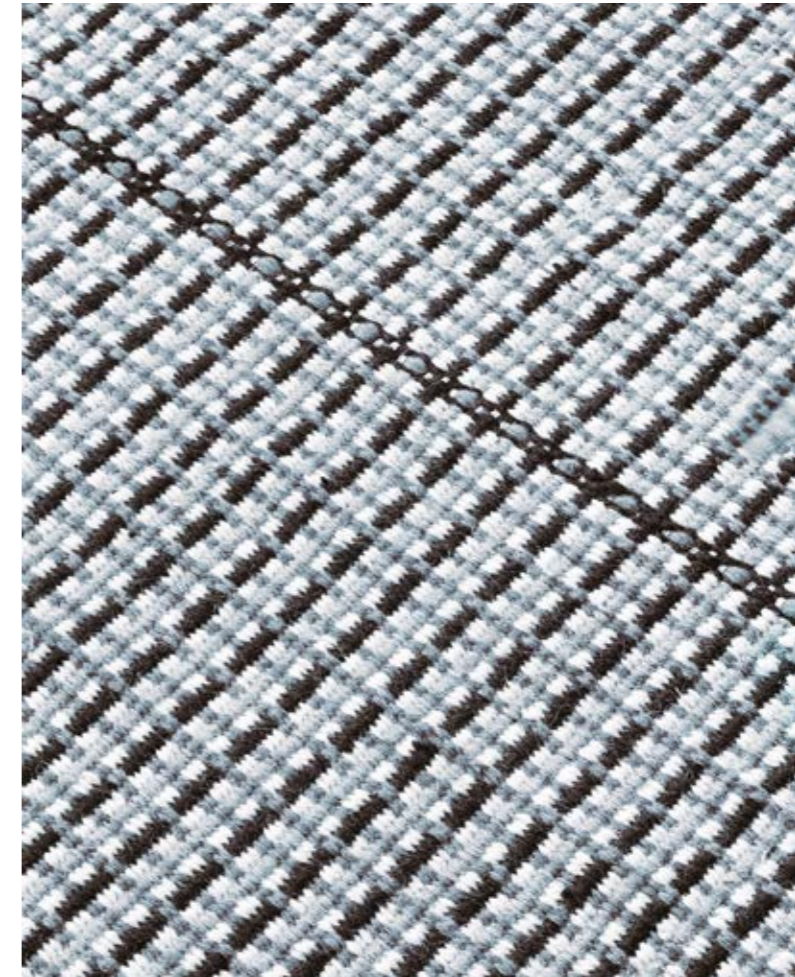
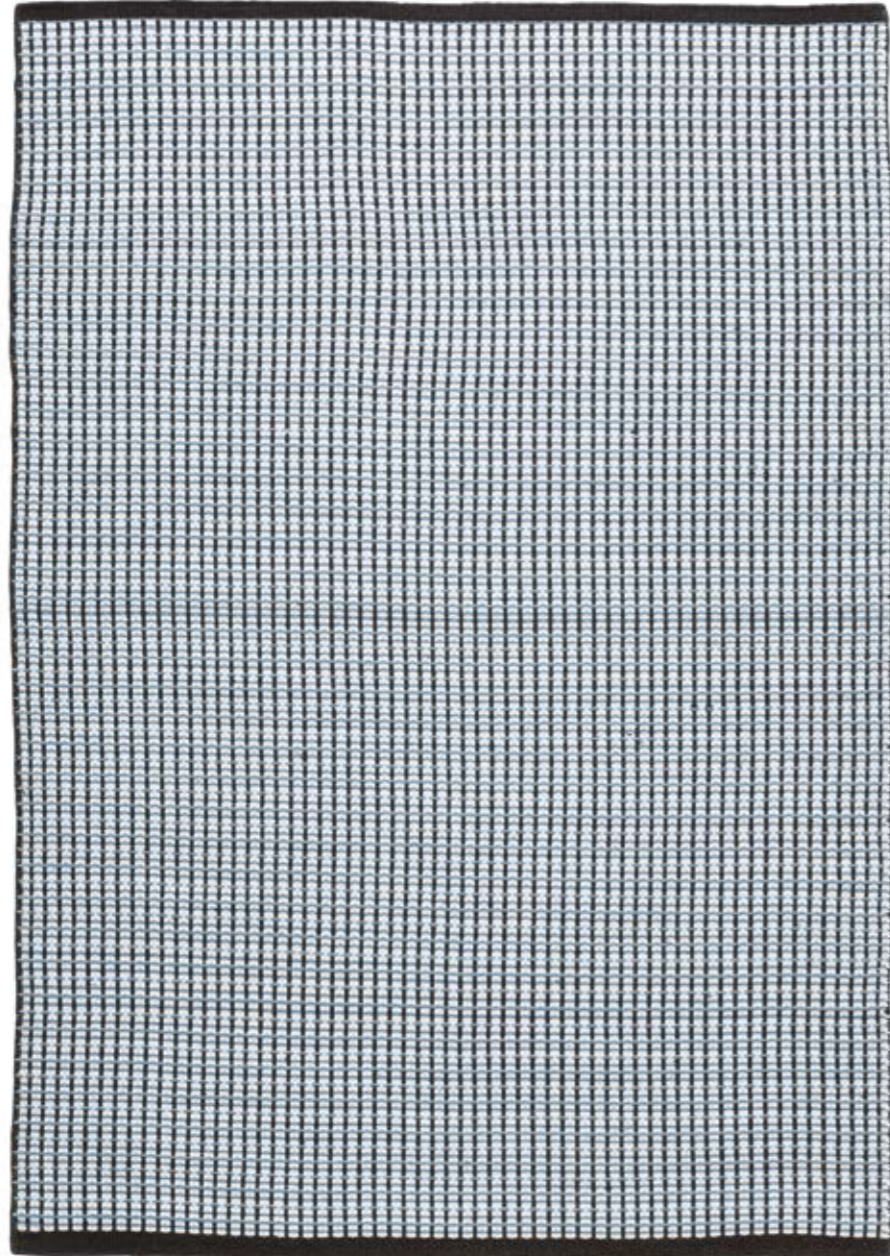

Oasis 1.2

IT — Scorrevole e fluido, un tappeto dai colori cangianti tra correnti di trame e ordito.

EN — Flowing and fluid, a rug with shimmering colours in a current of weft and warp.

Designer: Karpeta Team

Technique: Handwoven

Dimension: 170 x 240 - 200 x 300 cm

Special dimension available on request

Composed: 90% Tencel + 10% Cotton

Weight: 5,5 Kg mq

Technical Info: page 199





Oasis 2

IT — Una superficie morbida e vellutata; texture delicate e rigorose, nuances contemporanee, dettagli luminosi e discreti: una ricca palette di suggestioni per creare ambienti raffinati e moderni, con un design dal fascino intramontabile.

EN — Delicate and minimal textures, contemporary hues, bright and discreet details: a rich palette of suggestions to create refined, modern venues, with a design of timeless charm.





Designer: Karpeta Team

Technique: Handwoven

Dimension: 170 x 240 - 200 x 300 cm

Special dimension available on request

Composed: 90% Tencel + 10% Cotton

Weight: 5,5 Kg mq

Technical Info: page 200

Moq

IT — Lunghe frange su colori eleganti, per un tocco di stile di attraente morbidezza.

EN — Long fringes on elegant colours, for a touch of class and seductive softness.

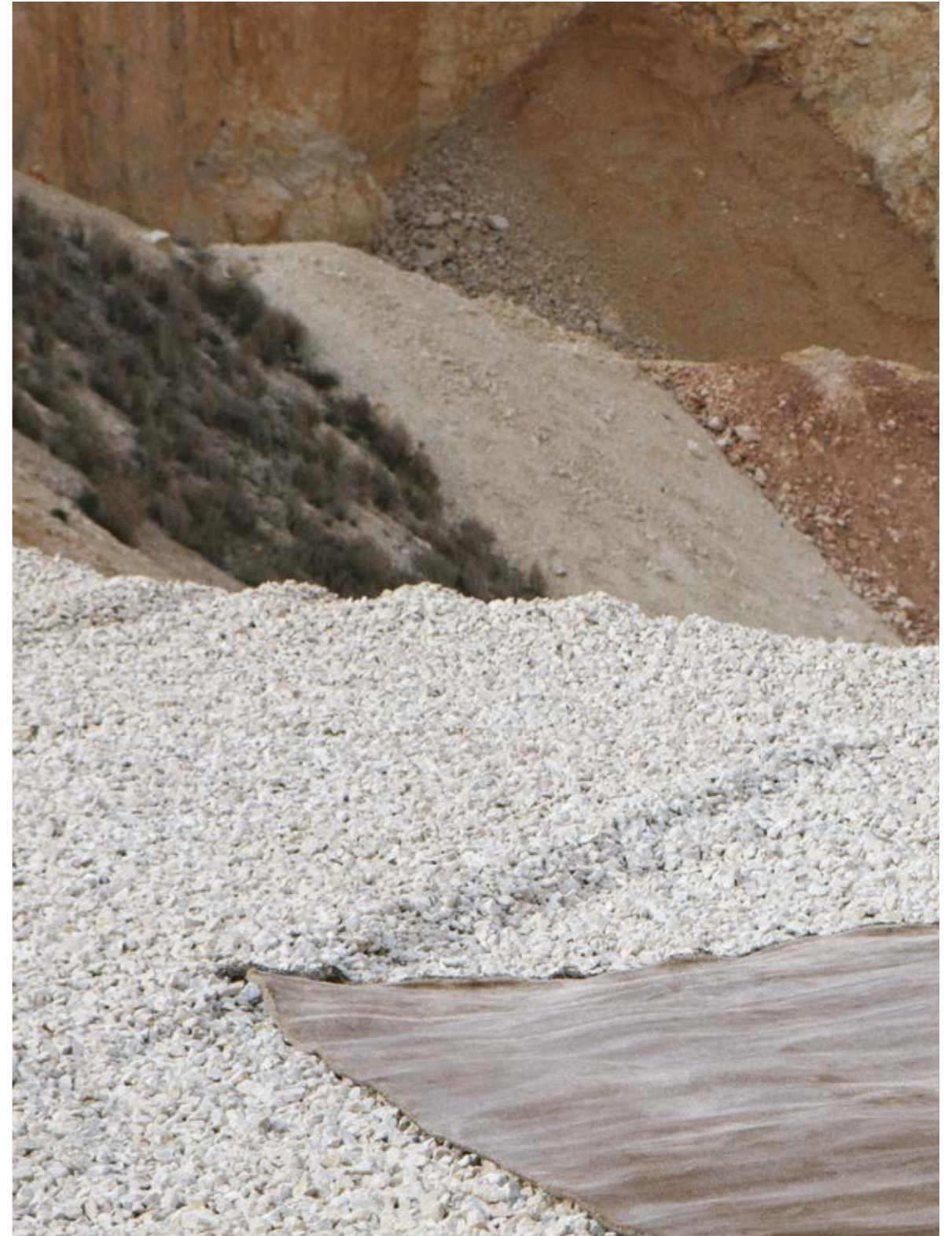



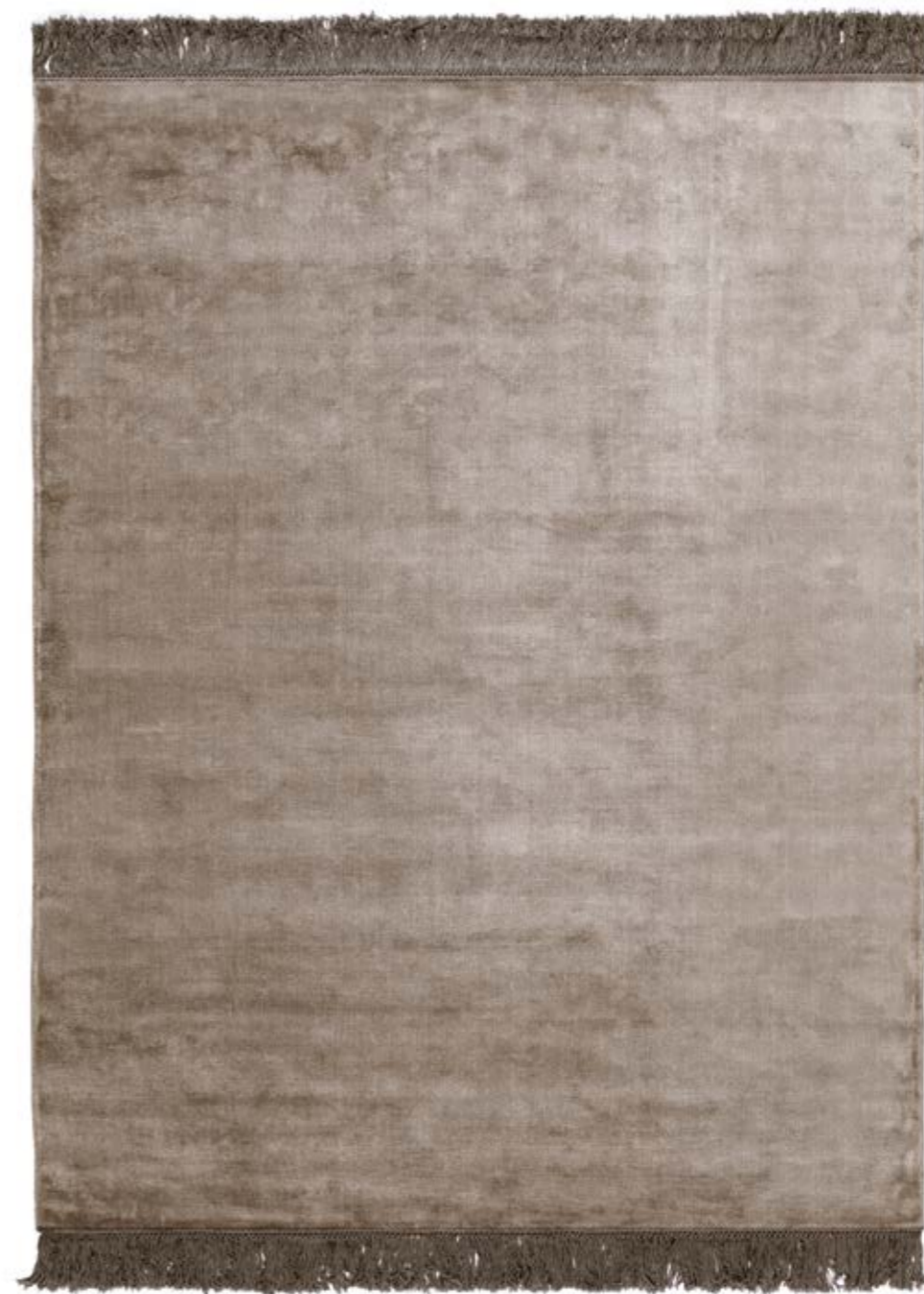

Designer: Karpeta Team

Technique: Handwoven

Dimension: 170 x 240 - 200 x 300 cm

Special dimension available on request

Composed: 90% Tencel + 10% Cotton

Weight: 4,3 Kg mq

Technical Info: page 200

Raw

Preziosi come arazzi, sorprendenti e ipnotici come tele d'arte moderna, i tappeti della collezione "Raw" emancipano l'arte del kilim dal disegno tradizionale ibridandola con paesaggi lunari, righe puntiformi e impensate sovrapposizioni di nuance. Ispirati dalle matite di Elsa Boch & Ferréol Babin, Giulia Ferraris, Studio Testo sono ponte tra una tecnica antica ed una nuova espressione estetica. —

Precious like tapestry, surprising and hypnotic like modern art paintings, the rugs of the collection "Raw" enhance the kilim by mixing conventional drawing with lunar landscapes, dotted lines and unexpected overlays of nuances. Inspired by designers Elsa Boch & Ferréol Babin, Giulia Ferraris, Studio Testo, the "RAW" rugs create a bridge between an ancient technique and a new estetic expression.

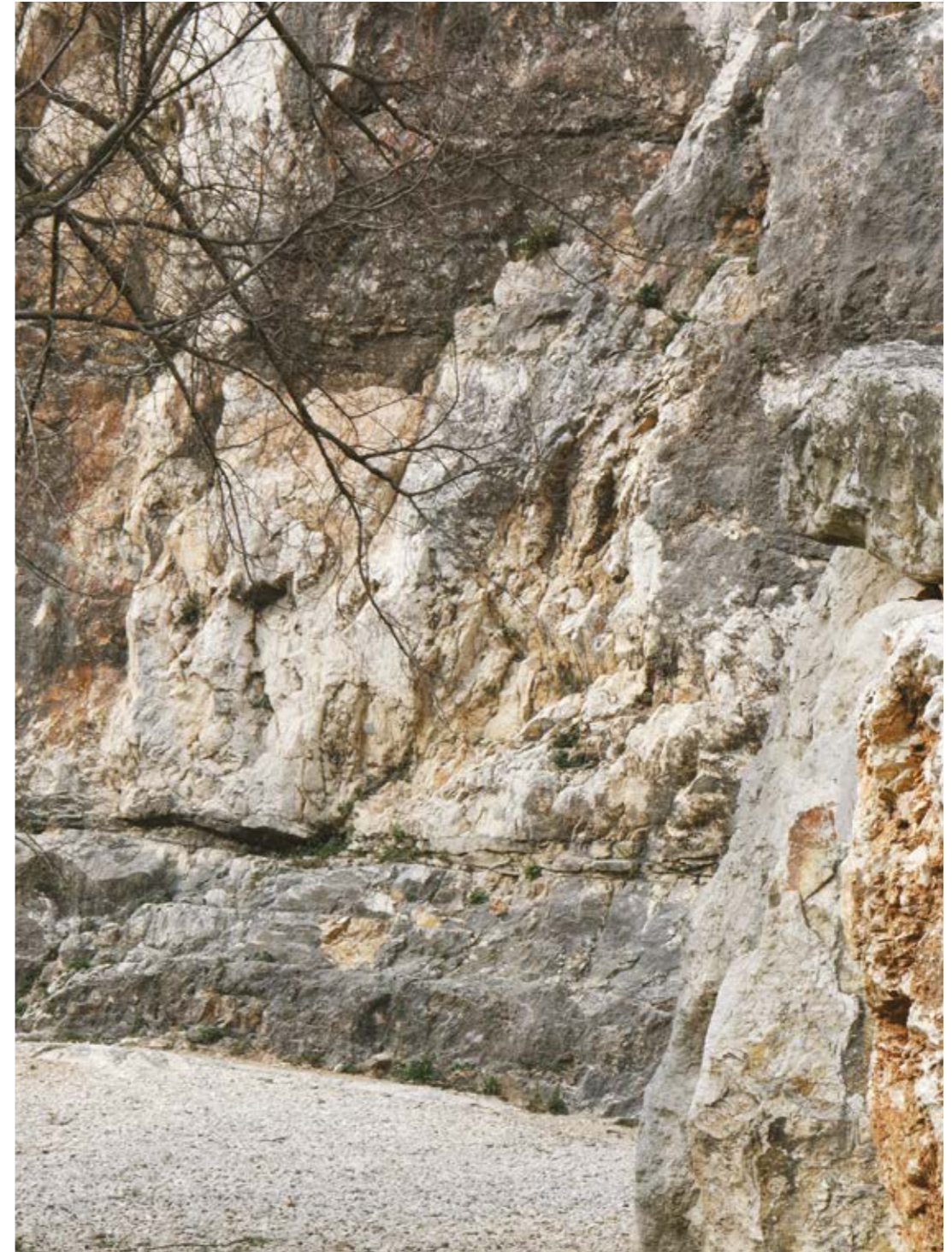

Magneto

IT — Da lontano a chiudere. Da lontano possiamo vedere chiaramente un disegno molto classico: grandi strisce dai colori contrastanti. Ma più ci si avvicina al tappeto, più la texture si sfuma e si arricchisce di colori scintillanti. L'intricata rete di fili disegna centinaia di macchie colorate che rivelano e sottolineano la meticolosità dell'artigiano e la ricchezza dei materiali e delle tonalità.

EN — From far to close. From far we can distinctly see a very classical drawing: large stripes in contrasting colors. But the closer you get to the carpet, the more it gets blurred and full of sparkling colors. The intricate network of threads draws hundreds of colored spots that reveal and underline the meticulousness of the craftsman and the richness of the materials and hues.

Designer: Elsa Boch&Ferréol Babin
Technique: Handwoven
Dimension: 170 x 240 - 200 x 300 cm
Special dimension available on request
Composed: 90% Wool + 10% Cotton
Weight: 3 Kg mq
Technical Info: page 202



Elsa Boch&Ferréol Babin



Mosaico

IT — Mosaico reinterpreta le decorazioni a mosaico, rappresentando il ponte tra una tecnica antica ed una nuova espressione estetica. Le strisce di colore che si intrecciano disegnano un motivo floreale geometrico e moderno. La finitura laterale a bande alternate abbinato al pattern a mosaico dà un tono eclettico alla composizione, rendendola vibrante e contemporanea.

EN — Mosaico reinterprets traditional mosaic work, creating a bridge between ancient techniques and innovative aesthetics. Twisting stripes of colors draw a geometric, modern floral pattern. The alternating bands of the side finishing combined with the mosaic pattern create an eclectic allure, making this creation vibrant and contemporary.

Designer: Giulia Ferraris
Technique: Handwoven
Dimension: 170 x 240 - 200 x 300 cm
Special dimension available on request
Composed: 90% Wool + 10% Cotton
Weight: 1,8 Kg mq
Technical Info: page 202



Giulia Ferraris

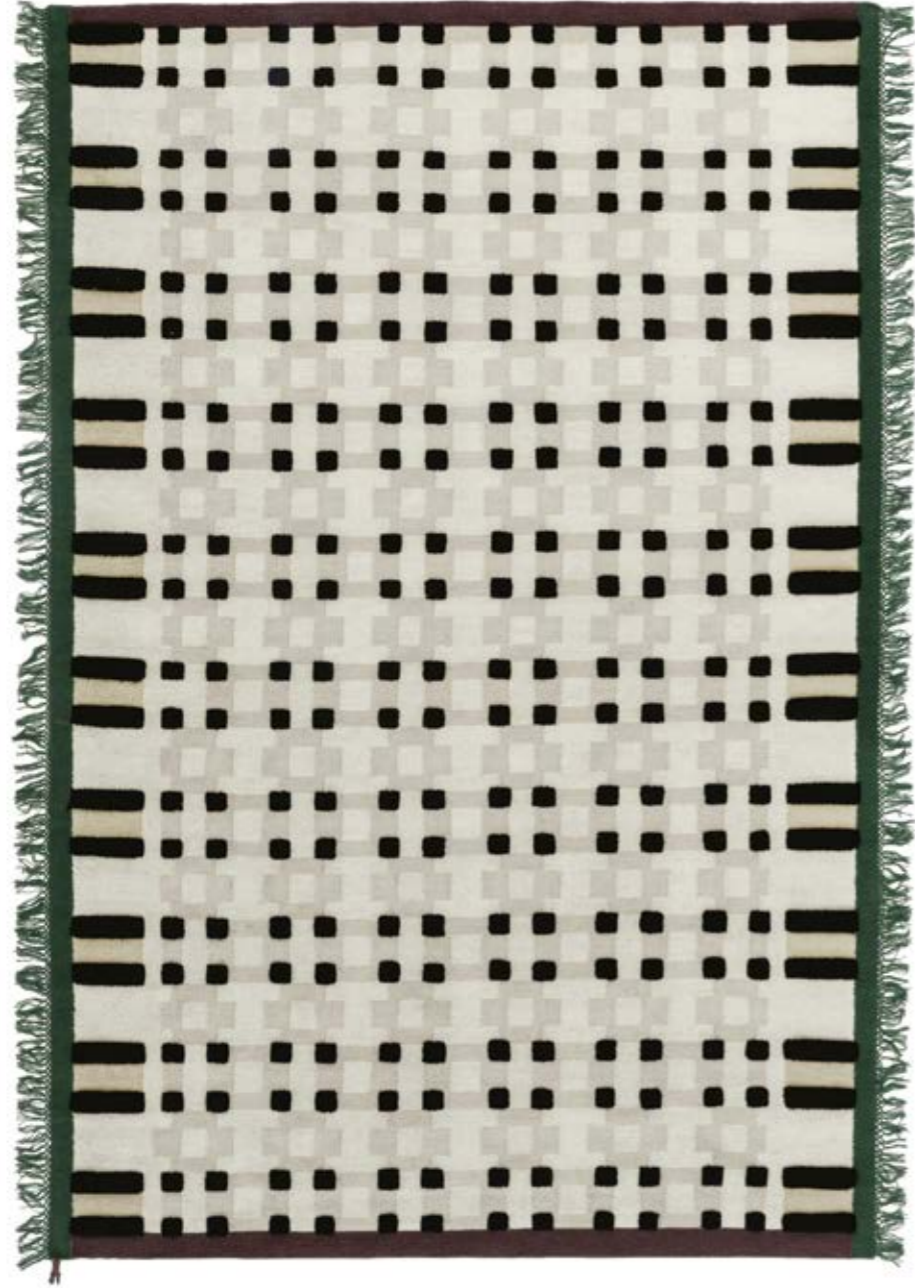



Acapo

IT — Acapo si ispira all'estetica reinterpretata di paesaggi architettonici esotici. L'aria è sabbiosa ed i colori caldi; diverse texture e materiali si accostano creando un disegno organizzato e regolare. Acapo è composto da semplici figure geometriche che si sovrappongono senza mai mescolarsi; blocchi di varie altezze e tecniche tessili diverse si alternano per creare una decorazione strutturata dall'aspetto grezzo che valorizza il "fatto a mano".

EN — Acapo is inspired by the aesthetic of exotic architectonic landscapes. The air is sandy and colors are warm; we matched different textures and materials, creating a tidy, regular design. Acapo consists of simple geometrical figures, placed one on top of the other but never mixing; blocks of different height and different textile techniques alternate to create an organized, rough decoration emphasizing the handmade effect.

Designer: Giulia Ferraris

Technique: Handwoven

Dimension: 170 x 240 - 200 x 300 cm

Special dimension available on request

Composed: 65% Wool + 25% Linen + 10% Cotton

Weight: 2,5 Kg mq

Technical Info: page 203



Giulia Ferraris



Blanco

IT — Blanco è una superficie carsica, un paesaggio lunare percorso da un segno secco, nero, minimo. Il suo spazio primitivo accoglie forme aggettanti e materiche di ghiaccio, gesso, cemento. Nella stanza è silenzio, riposo, stato di sospensione.

EN — Blanco is a Karst surface, a lunar landscape with a straight, black, minimal mark. Its primordial space embraces jutting, materic shapes of ice, plaster, concrete. In the room it creates silence, relax, a state of suspension.

Designer: Studio Testò
Technique: Handwoven
Dimension: 170 x 240 - 200 x 300 cm
Special dimension available on request
Composed: 90% Wool + 10% Cotton
Weight: 1,8 Kg mq
Technical Info: page 203



Studio Testò

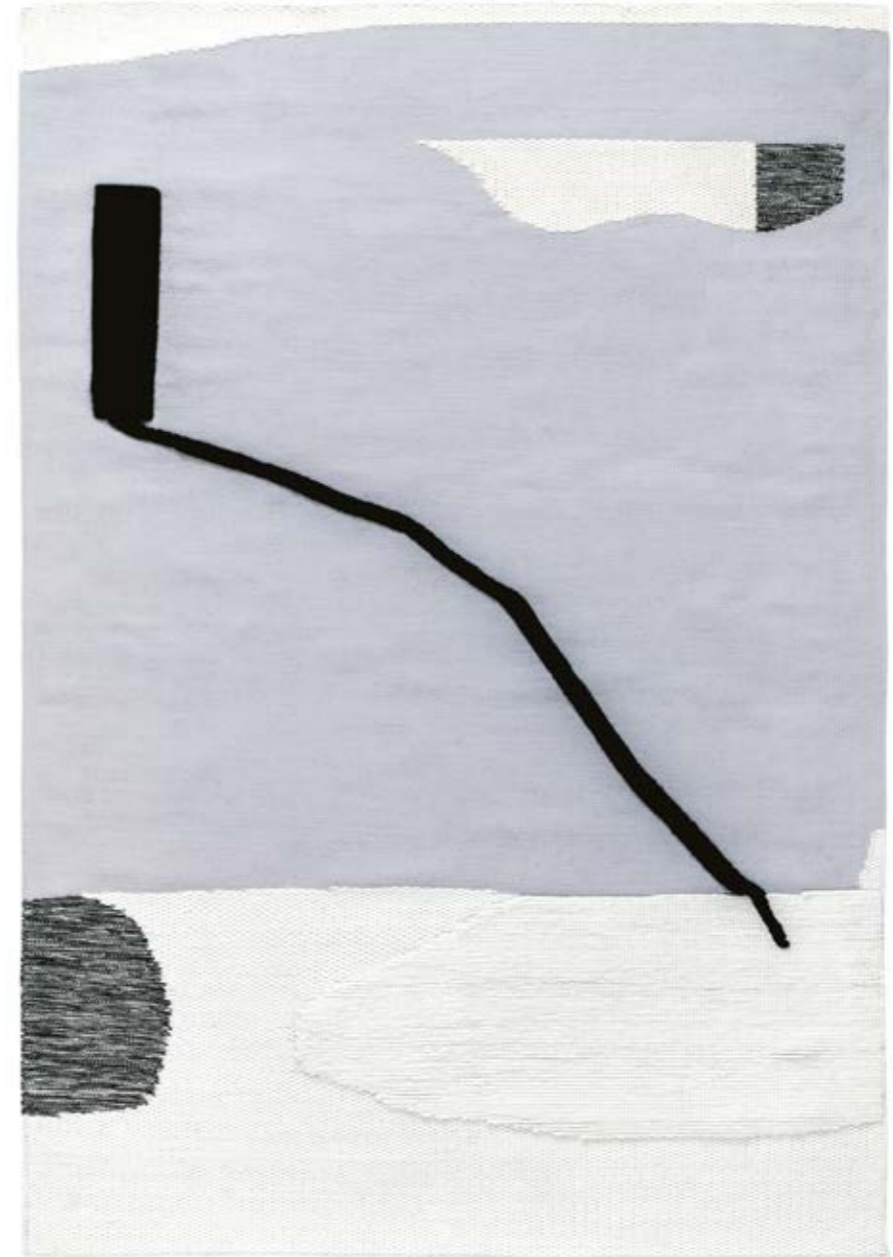



Rubia

IT — La divisione in fasce orizzontali e le decorazioni romboidali, estremamente semplificate, rievocano l'energia dei tappeti delle tribù nomadi asiatiche. La forza espressiva di Rubia viene esaltata dalle contrapposizioni cromatiche tra i colori caldi della base e le greche dai toni azzurri grigi. Per la realizzazione viene usata una tecnica mista, che consente al tappeto di avere diversi livelli per aumentare la tridimensionalità visiva.

EN — The horizontal divisions and the romboidal pattern of the carpet are inspired by the works of the nomadic asian tribe manufacturers. The Rubia's expressive power is amplified by colours contrast between the warm brown on the base and the light blue decorations. Mixed techniques have been used for the rug realisations in order to have different carpet veil heights and strong three dimensional effect.

Designer: Stefania Crippa – *Studio Contromano*

Technique: Handwoven and Overtuft

Dimension: 170 x 240 – 200 x 300 cm

Special dimension available on request

Composed: 90% New Zeland Wool + 10% Linen + 10% Cotton

Weight: 1,5 Kg mq

Technical Info: page 204





Pompon

IT — Giocando con le diverse altezze dei pois taftati, sono stati realizzati pompons che rendono questa superficie tattile e grafica.

EN — Playing with the different heights of tufted pois, pompons have been created to make carpet's surface tactile and graphic.







Designer: Lio de Bruin
Technique: Handwoven
Dimension: 170 x 240 - 200 x 300 cm
Special dimension available on request
Composed: 90% Wool + 10% Linen + 10% Cotton
Weight: 2 Kg/mq
Technical Info: page 204

Haiti

IT — La convivenza dei contrasti tra lana e viscosa, per un tappeto dalla geometria reticolare, che sfoga con frange ribelli.

EN — The coexistence of contrast between wool and viscose, in a rug with a reticulated geometric, leads to rebel fringes.

Designer: Karpeta Team
Technique: Handwoven
Dimension: 170 x 240 – 200 x 300 cm
Special dimension available on request
Composed: 70% Wool + 30% Viscose
Weight: 1,8 Kg mq
Technical Info: page 205



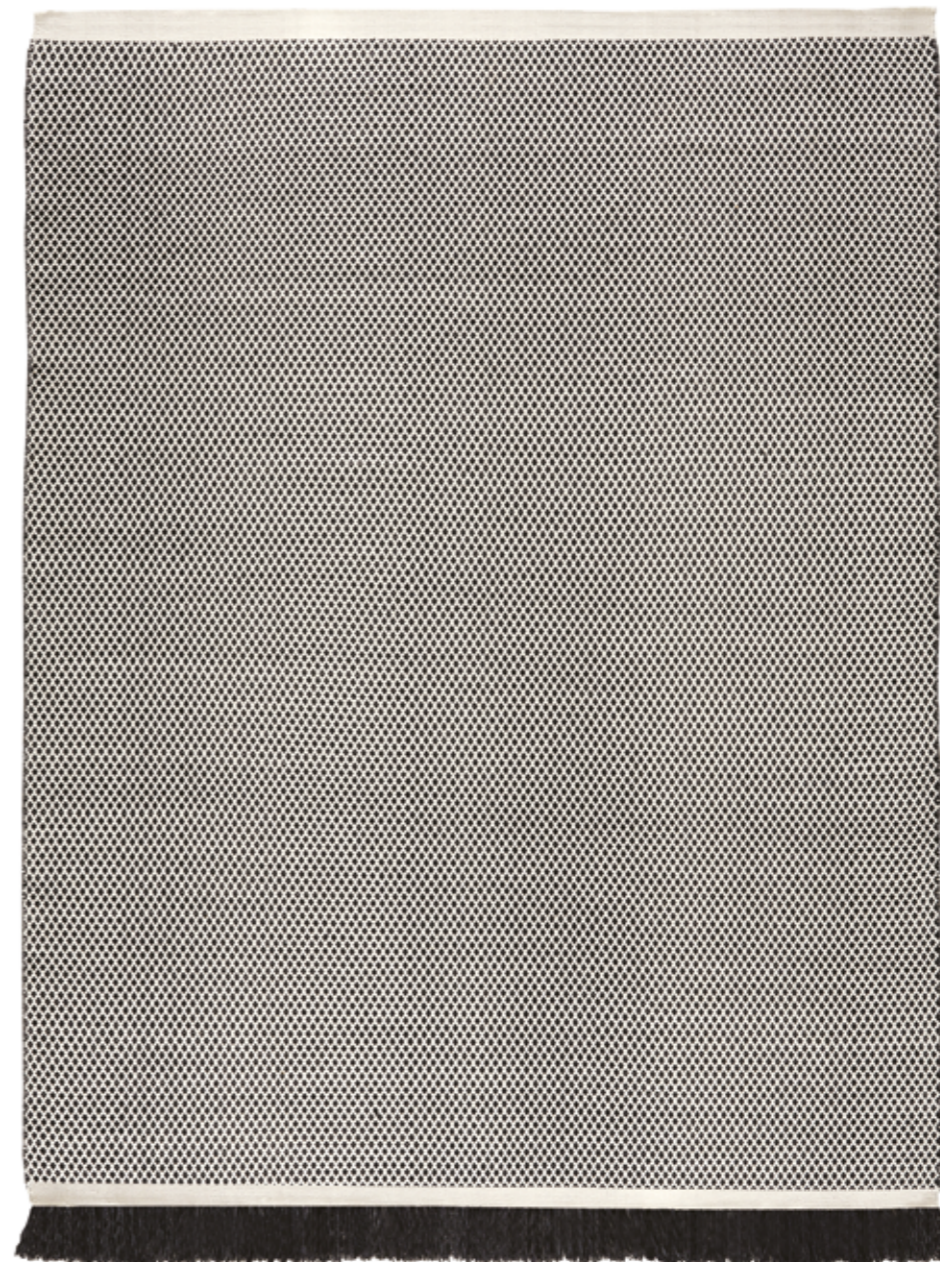

Kleos

IT — Intrecci di filati molto diversi tra loro disegnano una superficie “double”, rigorosa da un lato e fitta di intrighi dall'altra. Feltro, juta e poliestere ne sono i protagonisti

EN — Twist of yarns different from one another, drawing a double surface that is rigorous on one side, and dense of twines on the other. Felt, jute and polyester play the leading role.

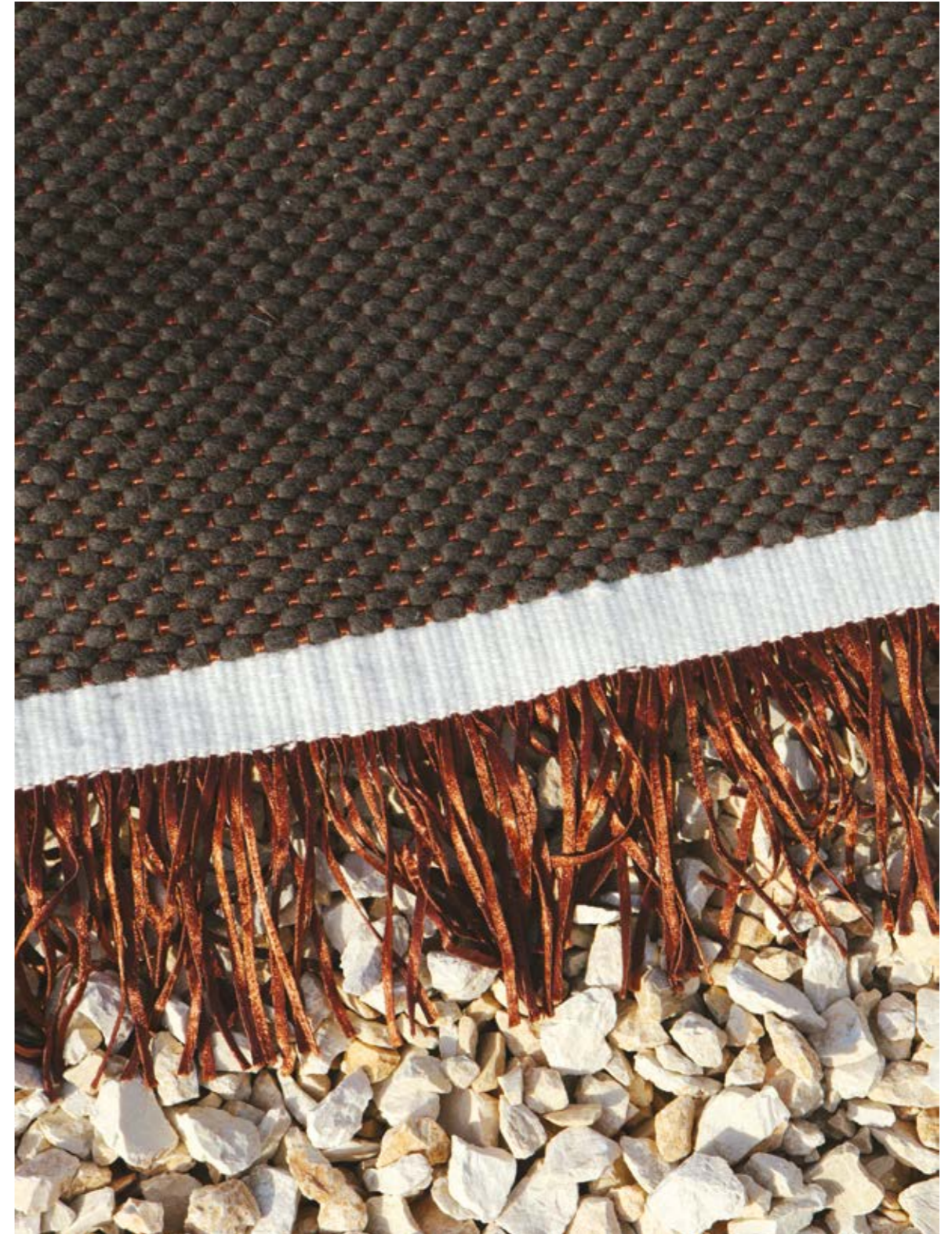

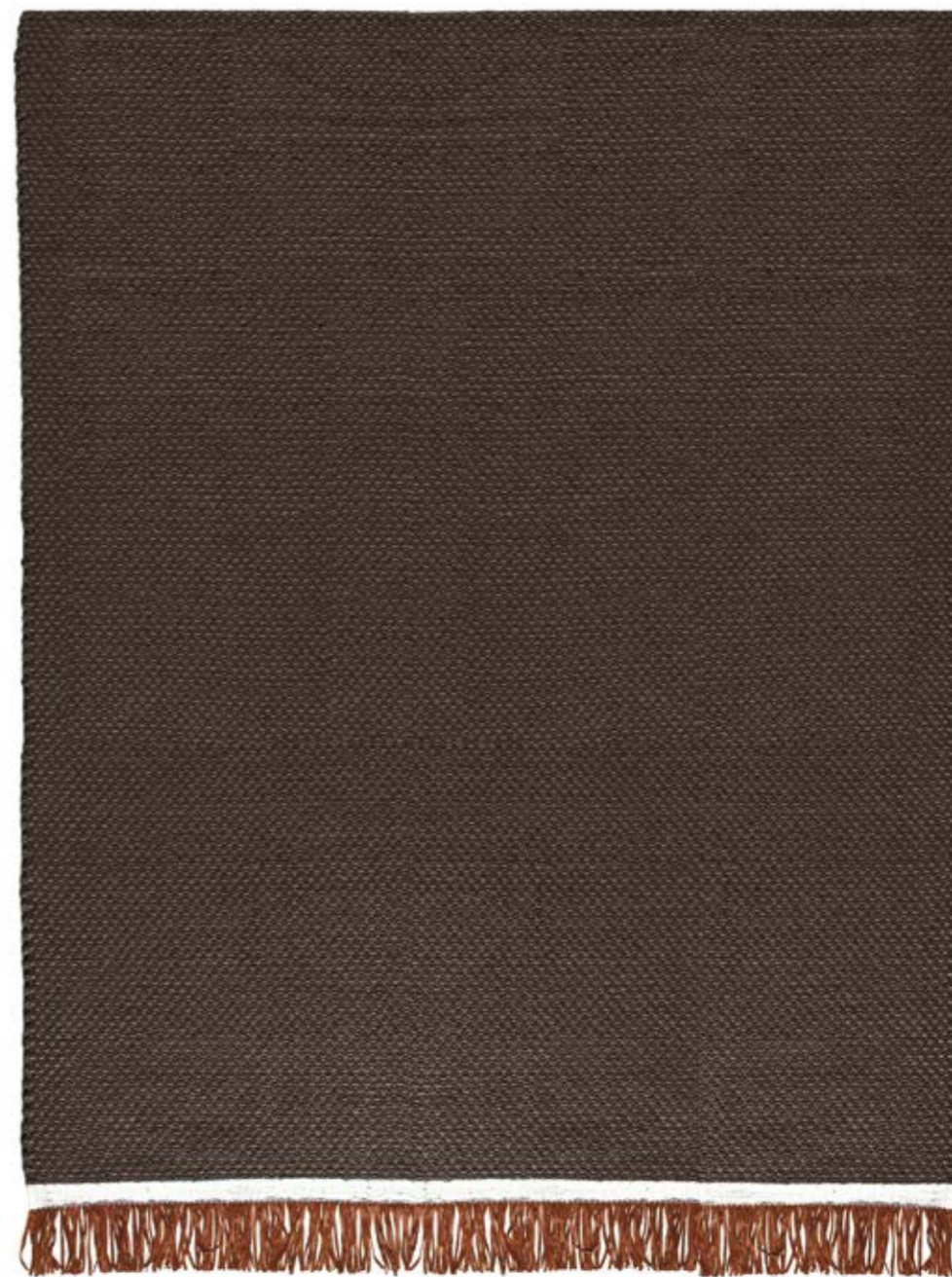

Designer: Elisa Polimeni
Technique: Handwoven
Dimension: 170 x 240 - 200 x 300 cm
Special dimension available on request
Composed: 70% Felt + 20% Polyester + 10%Yute
Weight: 3,8 Kg mq
Technical Info: page 205

Kura

IT — Tessuti su ordito di poliestere, i cordini di feltro appaiono e scompaiono in trama disegnando una superficie puntinata che termina con una frangia composta e compatta.

EN — Thin felt cords appear and disappear from the polyester warp and find their identity in the straight, compact fringes on the side.

Designer: Karpeta Team

Technique: Handwoven

Dimension: 170 x 240 - 200 x 300 cm

Special dimension available on request

Composed: 50% Felt + 50% Polyester

Weight: 4 Kg mq

Technical Info: page 206



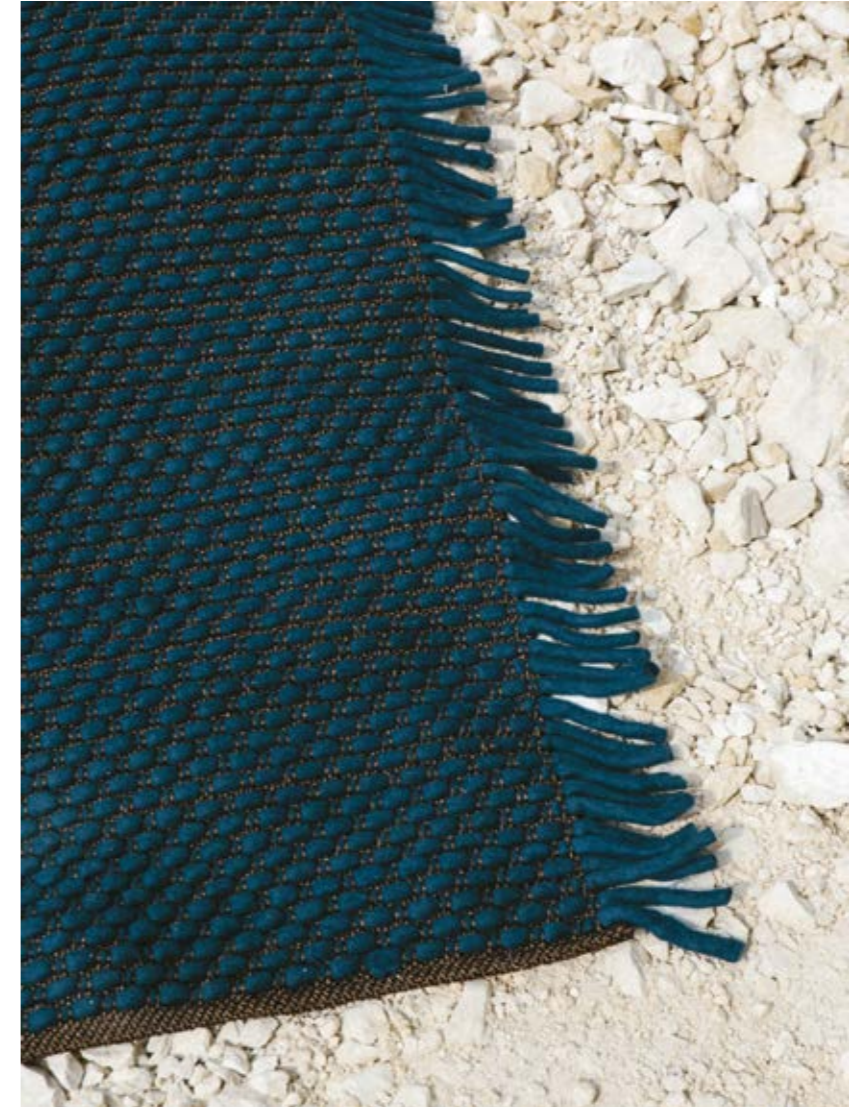

Meknès

IT — Pattern raffinati, colori rilassanti, per questo tappeto ispirato ai mosaici in ceramica marocchini.

EN — Refined patterns, relaxing colors, for this carpet inspired by Moroccan ceramic mosaics.



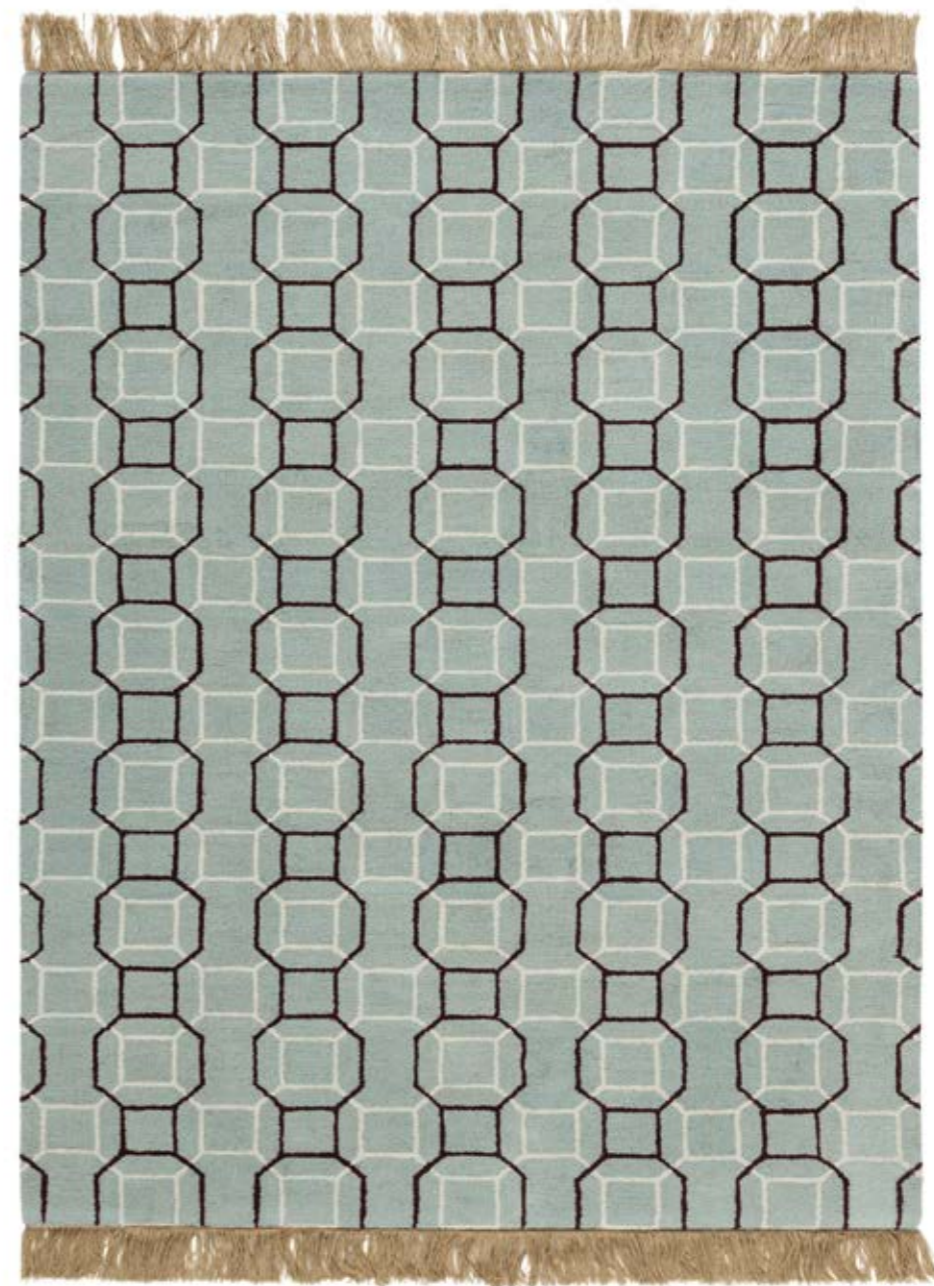

Designer: Karpeta Team

Technique: Handwoven

Dimension: 170 x 240 - 200 x 300 cm

Special dimension available on request

Composed: 50% Wool + 40% Jute + 10% Cotton

Weight: 2 Kg mq

Technical Info: page 206

Zullayj

IT — Motivi geometrici di ispirazione berbera, sovrapposti ed intrecciati creano un effetto labirinto i cui colori ricordano le calde atmosfere marocchine.

EN — Geometric motifs of Berber inspiration, overlapped and twisted create a maze effect whose colors recall the warm Moroccan atmospheres.

Designer: Karpeta Team

Technique: Handwoven

Dimension: 170 x 240 - 200 x 300 cm

Special dimension available on request

Composed: 50% Wool + 40% Jute + 10% Cotton

Weight: 2 Kg mq

Technical Info: page 207



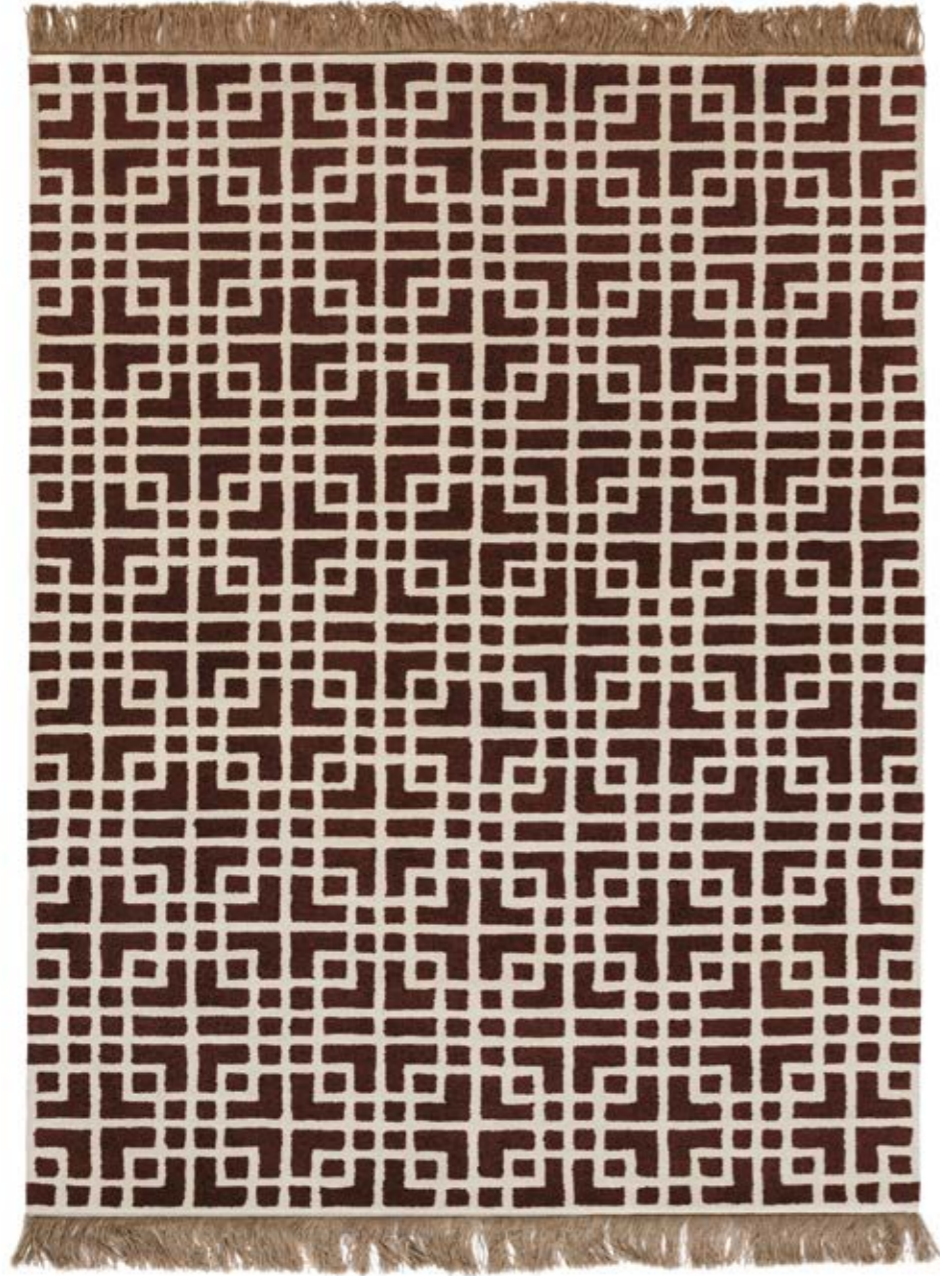

Printed

Stampate con tavole di legno scolpite a mano, le creazioni della linea “Print”, impreziosita dalle matite dello Studiocharlie & Silvia Destito sono fantasia che diventa filato. —

Printed using handsculpted wooden boards, the rugs of the collection “Print” by Studiocharlie & Silvia Destito come as a result of fantasy expressed in yarns.

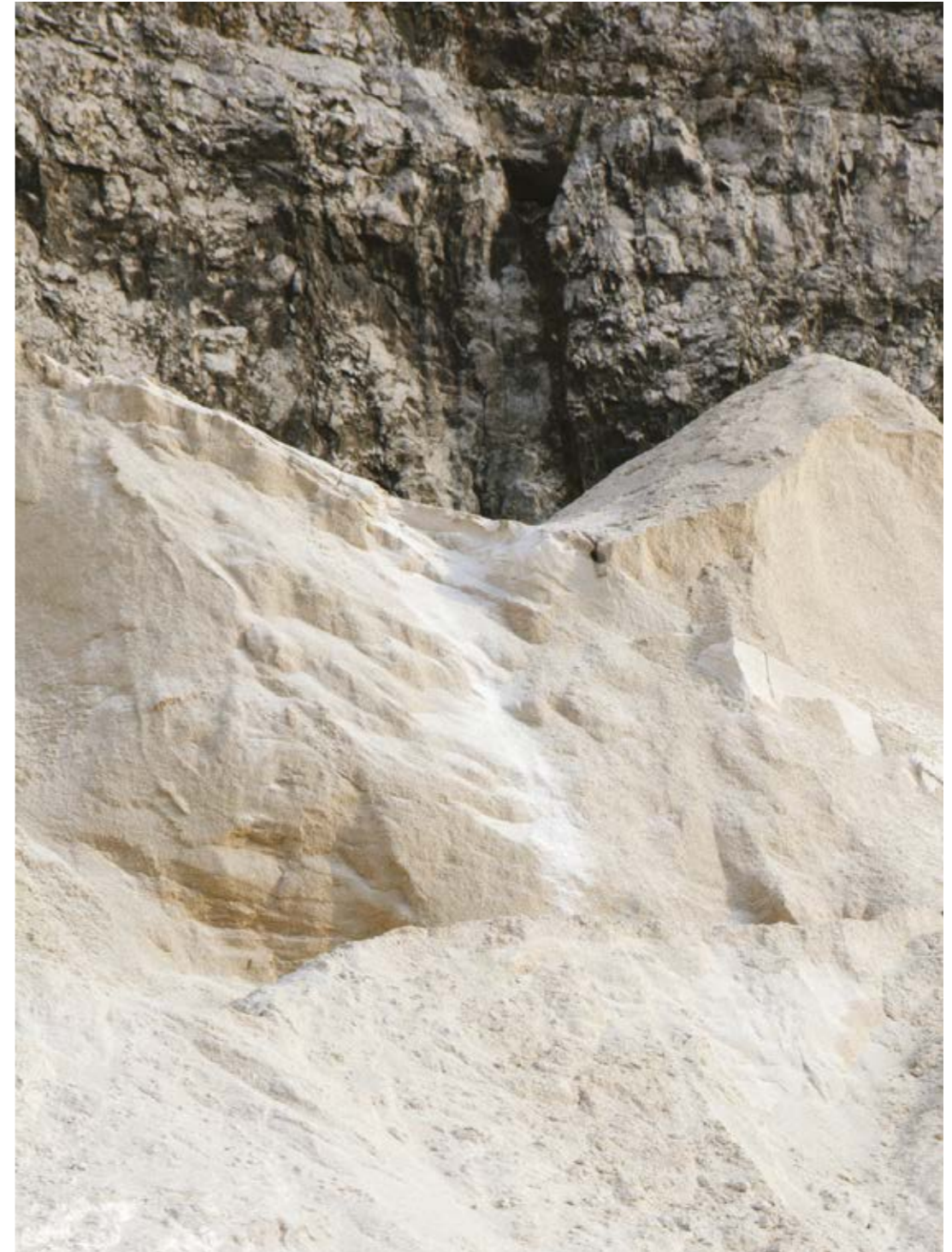

Torrente

IT — Il tappeto Torrente nasce dalla sperimentazione della stampa su tappeto. L'acqua diventa colore per segnare il suo passaggio sulla materia tessile. La tecnica della stampa permette di trasmettere la sensazione del passaggio rapido e stratificato di un corso d'acqua. Il torrente, con il suo fluire costante e impetuoso, accompagna lo scorrere del tempo, e invita alla contemplazione. L'acqua percorre una strada già tracciata perché impressa nella terra da infiniti passaggi che si rinnovano con regolarità. Ma allo stesso tempo è sempre presente una grande componente di indeterminazione, di casualità e di imprevedibilità.

EN — The rug Torrente originates from the experimentation of printing on rugs. Water changes into color to mark its way on the textile matter. The printing technique emphasizes the feeling of the fast, layered water flow. The torrent, its constant, impetuous flow follows the passage of time and invites to contemplate. The water flows through a path that has already been traced and impressed on the soil an infinity of times, and that keeps changing over time. But at the same time, in this long journey through a path that keeps changing, there'll always be room for uncertainty, luck and unpredictability.

Designer: Studiocharlie & Silvia Destito
 Technique: Handloom – Screen Printing
 Dimension: 170 x 240 – 200 x 300 cm
Special dimension available on request
 Composed: 90% Tencel + 10% Cotton
 Weight: 4,2 Kg mq
 Technical Info: page 207

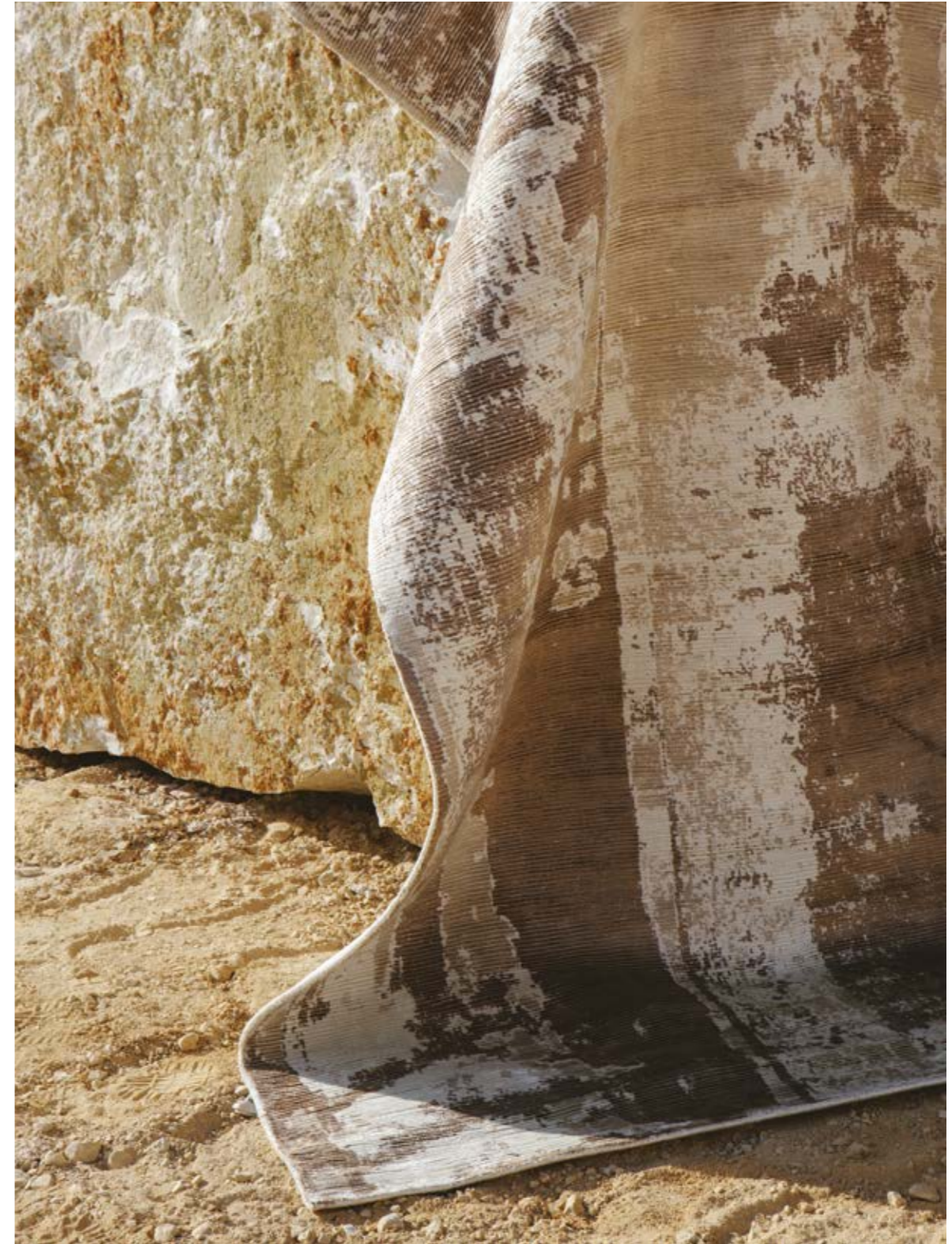

Studiocharlie & Silvia Destito





Nodi

Grafismi, geometrie astratte, macchie di colore emancipate a flora possibile, anatomie di emozioni rivivono nella collezione “Nodi” che grazie alle visionarie matite di Rosemarie Auberson, Valentina Cameranesi, Casalinghe di Tokyo, José Mendoza trasforma l’antica arte dell’annodato in design d’avanguardia. —
Graphic elements, abstract geometries, color stains cut loose to create floral patterns, analysis of emotions: the collection “Nodi” reveals the visionary talent of Rosemarie Auberson, Valentina Cameranesi, Casalinghe di Tokyo, José Mendoza, capable of changing the ancient hand-knotted technique into avantgarde design.



Friendly

IT — Un incontro lineare di trama e ordito in cui la delicatezza dei colori ed il contrasto tra le fibre conferisce al tappeto un linguaggio autonomo delle forme e dei colori.

EN — Linear encounter of weave and warp, soft colors and fibers in contrast enhancing the colors and shapes of this unique rug.

Designer: Karpeta Team
Technique: Handknotted
Dimension: 170 x 240 - 200 x 300 cm
Special dimension available on request
Composed: Wool + Jute on Cotton base
Weight: 4 Kg mq
Technical Info: page 208







Sliding

IT — Colori a contrasto “scorrono” sulla superficie creando nette separazioni a significare il passaggio radicale tra le diversità delle prospettive e dei punti di vista.

EN — Colors in contrast “flowing” along the surface to create clear separations that mark the radical change between the different perspectives and points of view.

Designer: Karpeta Team
Technique: Handknotted
Dimension: 170 x 240 – 200 x 300 cm
Special dimension available on request
Composed: Wool on Cotton base
Weight: 4,8 Kg mq
Technical Info: page 208







Le Ragazze

IT — Un disegno astratto di corpi di donna stilizzati. Forme morbide che diventano campiture dal contrasto nero-sabbia e oro con riferimento agli anni 40'.

EN — Abstract drawing of stylized female bodies soft shapes turning into painted backgrounds sand-black and gold colors in contrast ref 40s.

Designer: Valentina Cameranesi

Technique: Handknotted

Dimension: 170 x 240 - 200 x 300 cm

Special dimension available on request

Composed: Silk + Wool + Wool-Silk Blend on Cotton base

Weight: 4,6 Kg mq

Technical Info: page 209



Valentina Cameranesi



Psychedelic flower

IT — Ripresa del tema classico del floreale ma in scala oversize che lo fa diventare quasi astratto. Colori ispirati dal surrealismo di Labisse e Magritte e dalle stampe serigrafiche come un grande sketch per un tessuto di un abito un fiore psichedelico.

EN — Inspired by the classic floral motif but in oversize scale, which makes it almost abstract colors inspired by Labisse's and Magritte's surrealism and by the silk-screen printings.

Designer: Valentina Cameranesi

Technique: Handknotted

Dimension: 170 x 240 - 200 x 300 cm

Special dimension available on request

Composed: Silk + Wool + Tencel + Linen on Cotton base

Weight: 5 Kg mq

Technical Info: page 209

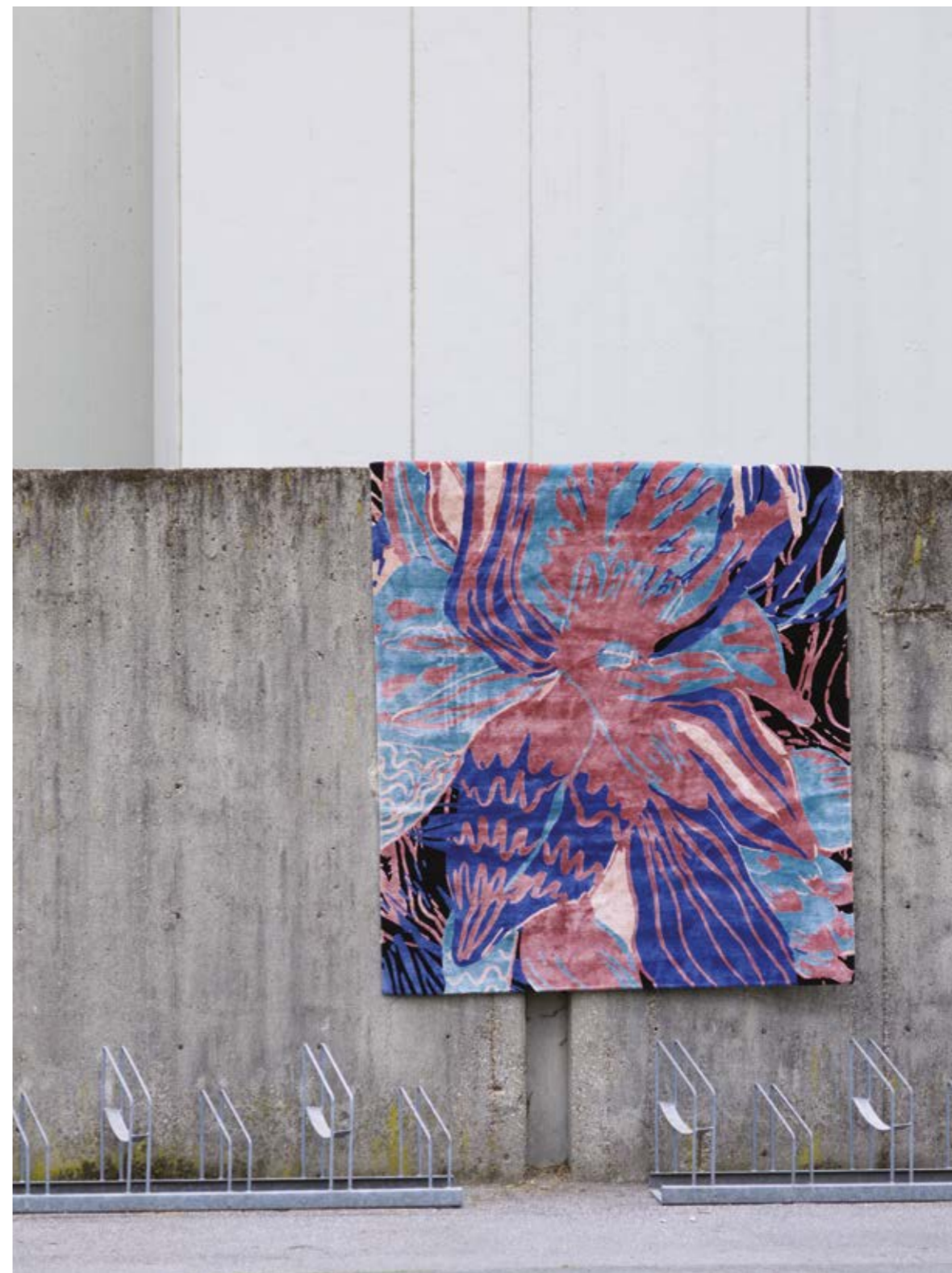

Valentina Cameranesi



Antique Rose and Black

IT — Questo è un collage con una composizione astratta di colori neutri, semplice ma forte nello stesso tempo. Sembra che questa composizione possa vivere molto tempo, che gli occhi possano contemplare queste forme senza mai stancarsi. Una tela dove la mente può pensare, contemplare e viaggiare.

EN — This is a collage with pure abstract simple composition and neutral colors but strong in the same time. It seems that this composition can live a long time, than the eyes can contemplate these shapes without being tired of them. I hope it can be like a canvas where the mind can think, contemplate and travel.

Designer: Rosemarie Auberson

Technique: Handknotted

Dimension: 170 x 240 - 200 x 300 cm

Special dimension available on request

Composed: Silk + Wool on Cotton base

Weight: 3,7 Kg mq

Technical Info: page 210

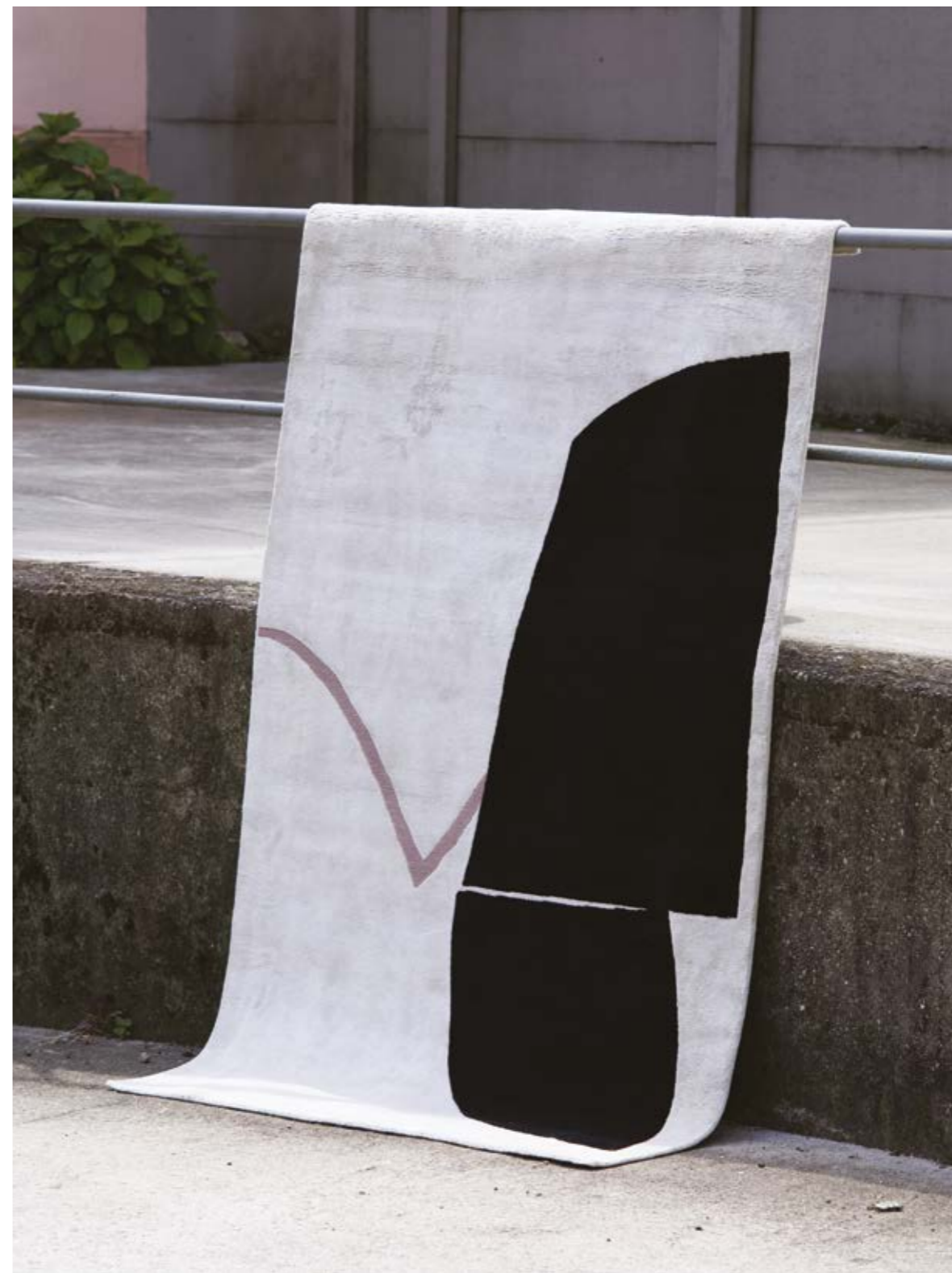

Rosemarie Auberson



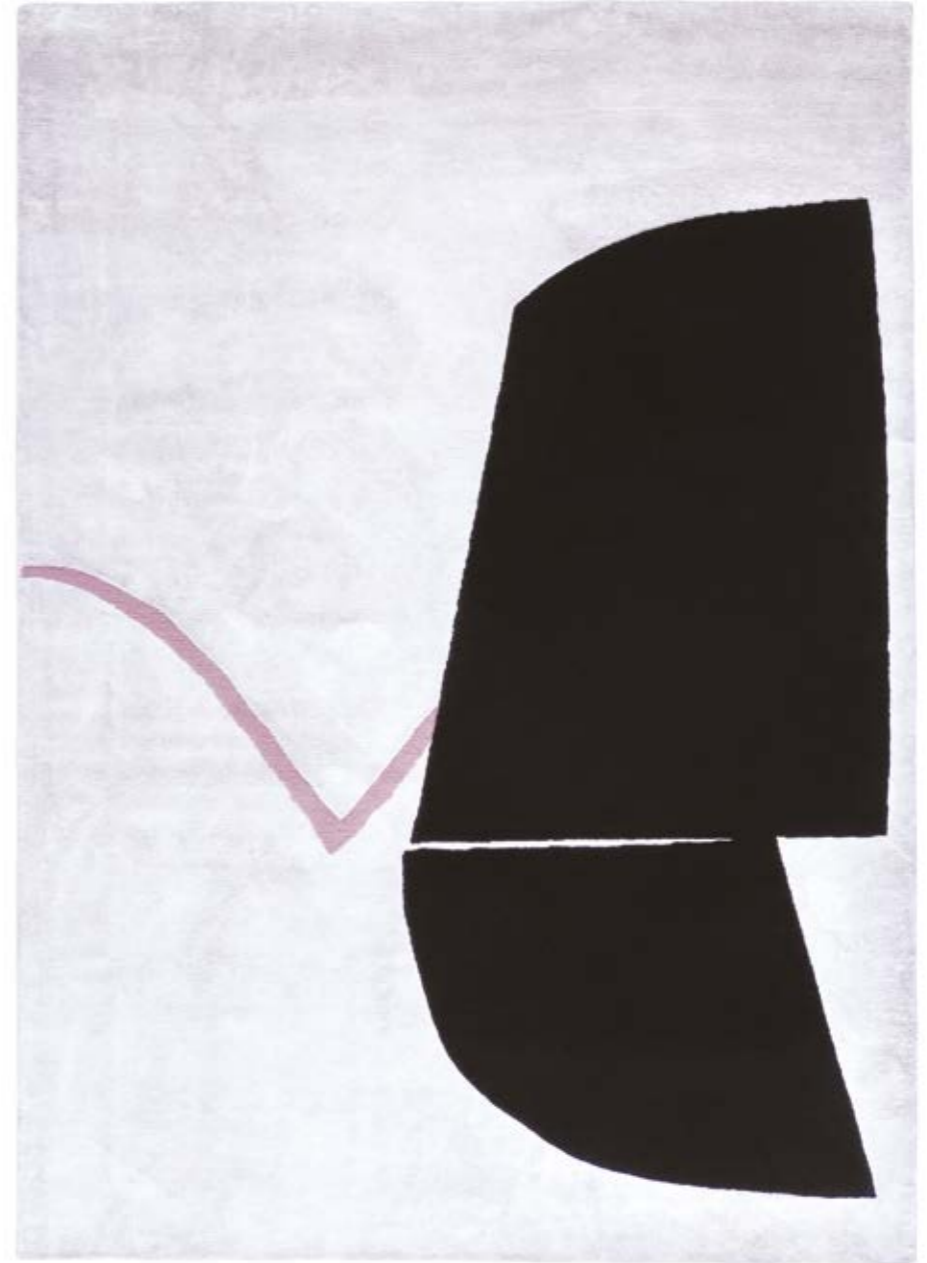

Esodo

IT — Esodo è un tappeto che racconta un recente fenomeno della penisola. Dopo la prima grande emigrazione Italiana di inizio '900 stiamo assistendo ad un altro grande, seppur più silenzioso esodo, figlio di una Europa senza frontiere e di una condizione socio/lavorativa instabile. L'idea di movimento è all'origine della nostra ricerca estetica pe Karpeta, sviluppata in chiave dinamica e minimale. Linee come percorsi che tagliano veloci la superficie. Ogni punto corrisponde ad una delle 20 regioni italiane. Uno spostamento affilato e caotico come veloci sono i percorsi di ogni individuo. L'elaborazione grafica dei dati è stata sviluppata e disegnata con Martina Merlini per Casalinghe di Tokyo.

EN — The rug Esodo is inspired by a recent phenomenon in Italy. Today we are witnessing another major, yet silent, exodus since the first large emigration in the early 1900s, as a result of a border-free Europe and unsteady social/working condition. The concept of movement lays at the foundation of Karpeta's aesthetic research, which we aim to develop in a minimal, yet dynamic way. Lines like paths, fast crossing the surface. Each dot corresponds to one of Italy's 20 regions. A sharp, chaotic movement that reminds us of the journey each individual has to get through. The graphic elaboration of the data has been developed and designed together with Martina Merlini for Casalinghe di Tokyo.

Designer: Casalinghe di Tokyo

Technique: Handknotted

Dimension: 170 x 240 - 200 x 300 cm

Special dimension available on request

Composed: Silk + Wool on Cotton base

Weight: 4,3 Kg mq

Technical Info: page 210



Casalinghe di Tokyo



Tintas

IT — Tintas (in spagnolo “inchiostrì”) è un tappeto annodato a mano utilizzando la tecnica Soumak. Il design presenta una composizione equilibrata di forme geometriche create attraverso linee colorate che si sovrappongono, emergono e scompaiono, come tratti spontanei disegnati a mano su un pezzo di carta. Tintas celebra la bellezza nascosta nei dettagli di semplici atti. I filati di lana tinti in colori vivaci e dettagli di toni più scuri sono combinati e mescolati insieme a seguito del ritmo di una griglia progettata minuziosamente su ogni nodo del tappeto.

EN — Tintas (the Spanish word for “inks”) is hand knotted carpet using the Soumak technique. The design features a balanced composition of geometric shapes created through colourful lines that overlap, emerge and disappear, like spontaneous hand drawn strokes on a piece of paper. Tintas celebrates the beauty hidden in details of simple acts. Wool yarns dyed in bright colours and details of darker tones are combined and blended together following the rhythm of a grid that has been meticulously designed on each knot of the rug.

Designer: José Mendoza

Technique: Handknotted and Soumak Weave

Dimension: 170 x 240 – 200 x 300 cm

Special dimension available on request

Composed: Wool + Jute on Cotton Warp

Weight: 3,3 Kg mq

Technical Info: page 211

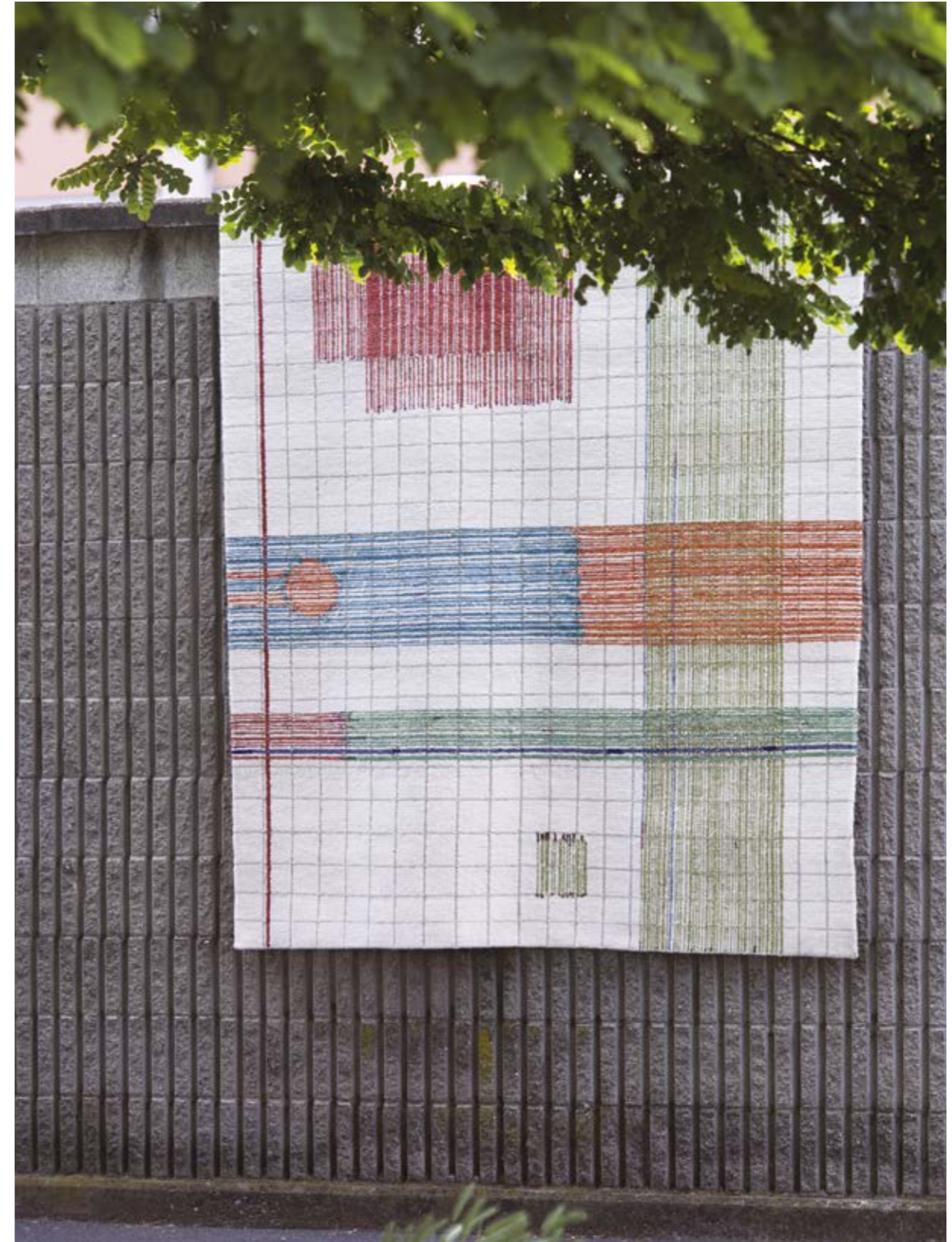

José Mendoza



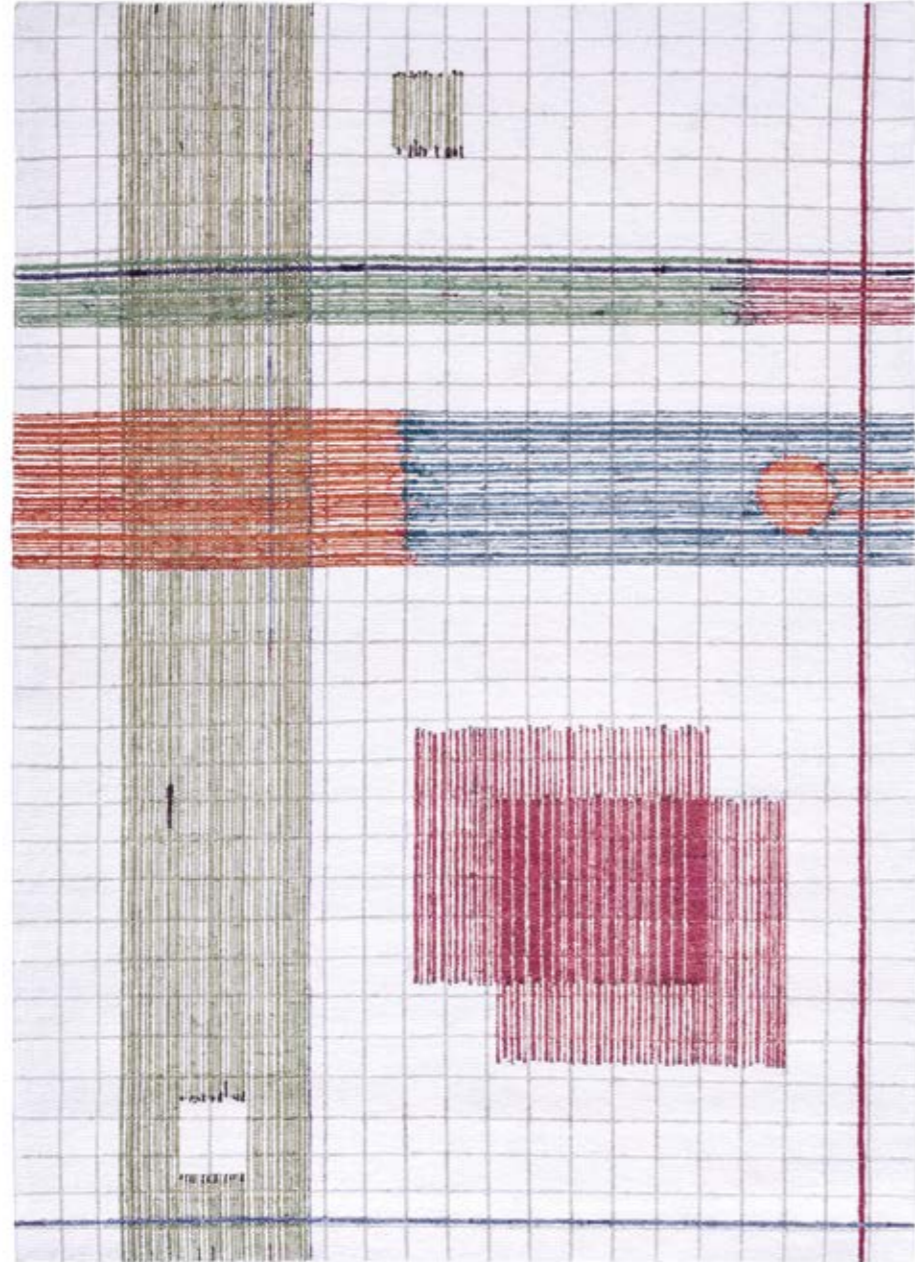

Technical Info

Ogni tappeto Karpeta è 100% Made in India, realizzato con lavorazioni artigianali e materie prime di altissima qualità. Lino, lana, seta e cotone si intrecciano in creazioni dallo stile moderno e contemporaneo —

Each and every Karpeta rug is entirely hand made in India using only the highest quality raw materials. Linen, wool, silk and cotton are blended to create beautiful rugs with a modern and contemporary twist.

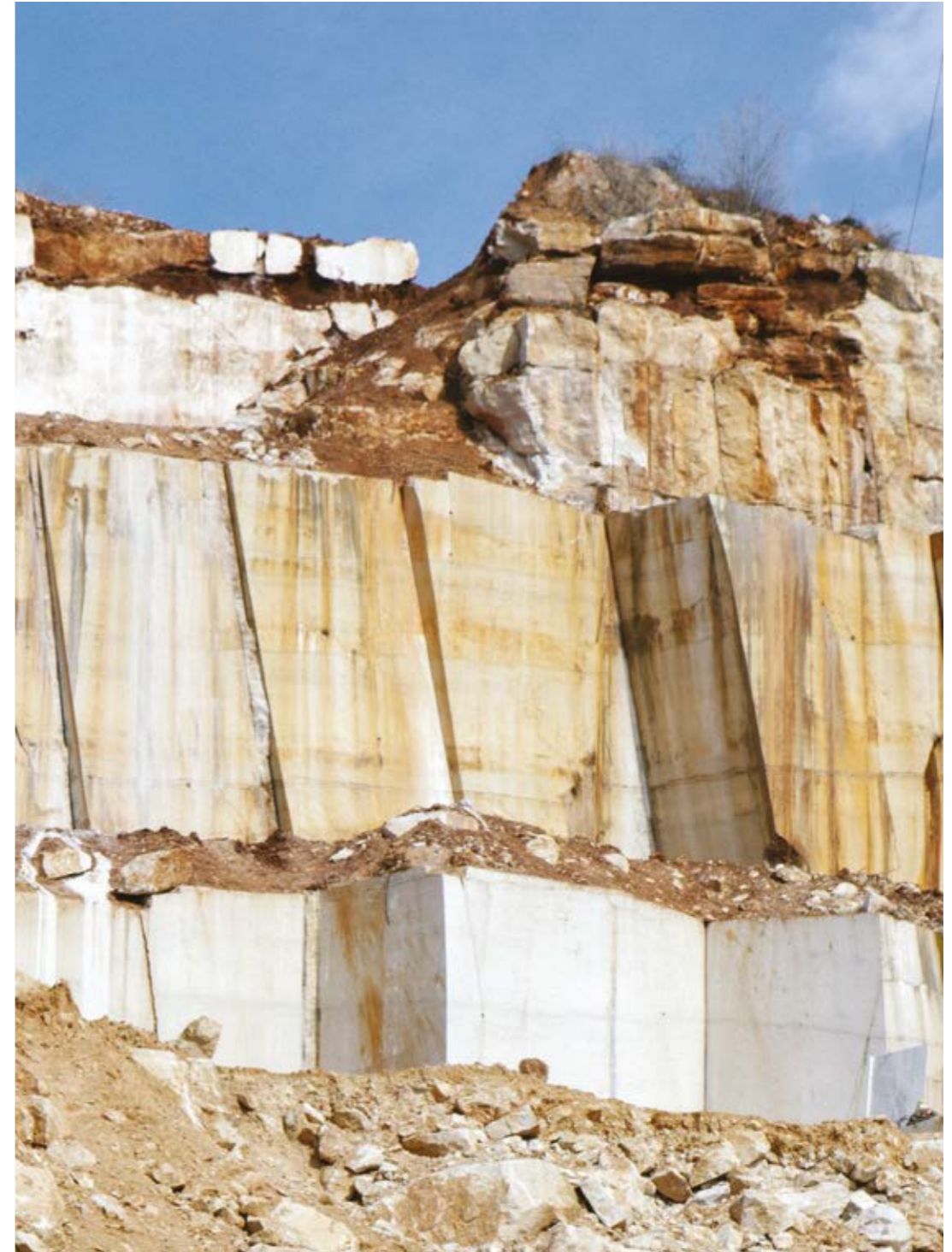



Halfstripe

New Friends

Photo page: 020

Technique: Handloom

Dimension: 170 x 240 – 200 x 300 cm

Special dimension available on request

Composed: 90% Wool + 10% Cotton

Weight: 2,5 Kg mq

Time production: Ready to delivery



(Un)fold

Studio Tomorrow

Photo page: 028

Technique: Handwoven

Dimension: 170 x 240 – 200 x 300 cm

Special dimension available on request

Composed: 10% New Zeland Wool +

20% Bamboo Silk + 70% Jute

Weight: 2,5 Kg mq

Time production: Ready to delivery



Indigo

Stefania Crippa

Studio Contromano

Photo page: 024

Technique: Handwoven

Dimension: 170 x 240 – 200 x 300 cm

Special dimension available on request

Composed: 70% Wool + 20% Linen + 10% Cotton

Weight: 2,3 Kg mq

Time production: Ready to delivery



Checkers

Karpeta Team

Photo page: 034

Technique: Handwoven

Dimension: 170 x 240 – 200 x 300 cm

Special dimension available on request

Composed: 90% Wool + 10% Cotton

Weight: 2,5 Kg mq

Time production: Ready to delivery



China
Valentina Cameranesi

Photo page: 038
Technique: Handwoven
Dimension: 170 x 240 – 200 x 300 cm
Special dimension available on request
Composed: 60% Wool + 30% Jute + 10% Cotton
Weight: 1,5 Kg mq
Time production: Ready to delivery



Pile
Lio de Bruin

Photo page: 048
Technique: Handwoven
Dimension: 170 x 240 – 200 x 300 cm
Composed: 90% Wool + 10% Cotton
Weight: 1,8 Kg mq
Time production: Ready to delivery

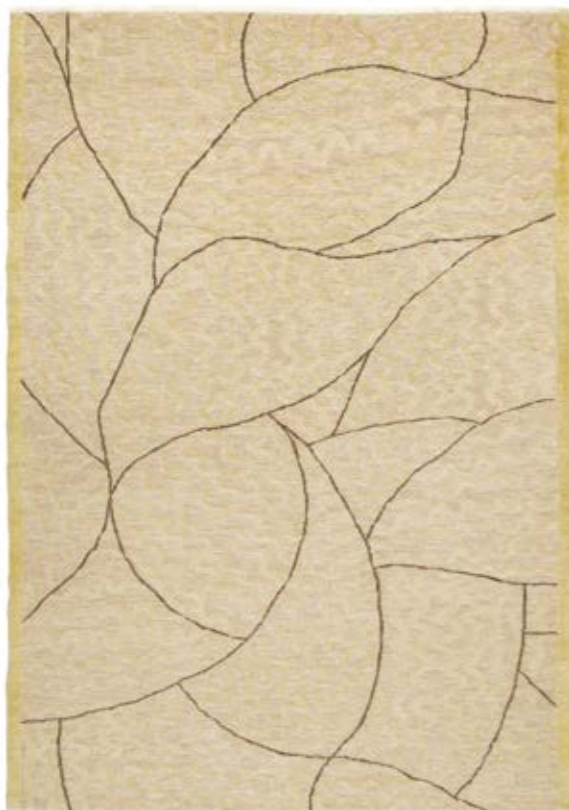

Treccia
Valentina Cameranesi

Photo page: 044
Technique: Soumak Overtuft
Dimension: 170 x 240 – 200 x 300 cm
Special dimension available on request
Composed: 50% Jute + 40% Bamboo Silk + 10% Cotton
Weight: 3,25 Kg mq
Time production: Ready to delivery



Checkmate
Karpeta Team

Photo page: 054
Technique: Handwoven
Dimension: 170 x 240 – 200 x 300 cm
Special dimension available on request
Composed: 45% Wool + 45% Jute + 10% Cotton
Weight: 1,8 Kg mq
Time production: Ready to delivery

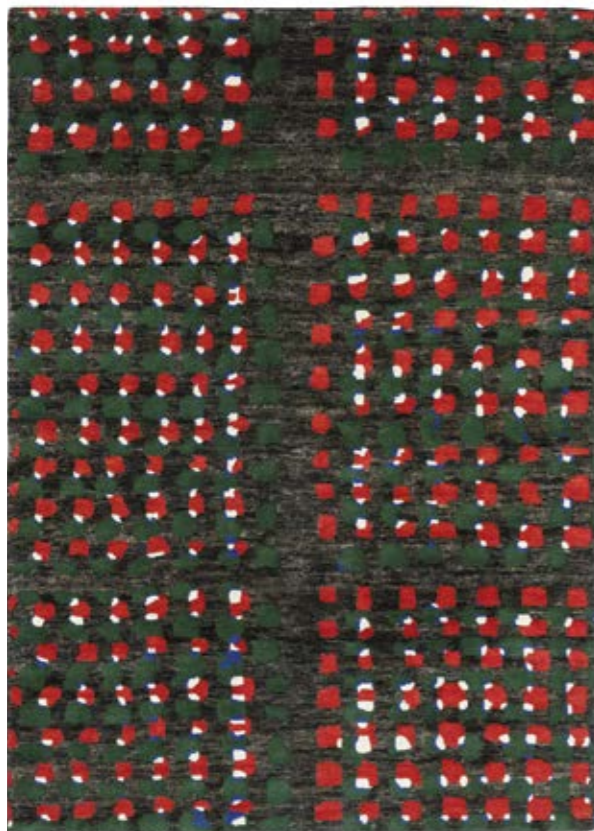

Tuo
Karpeta Team

Photo page: 058
Technique: Handwoven
Dimension: 170 x 240 – 200 x 300 cm
Special dimension available on request
Composed: 45% Wool + 45% Jute + 10% Cotton
Weight: 3,4 Kg mq
Time production: Ready to delivery



Net
Ilaria Innocenti

Photo page: 068
Technique: Handwoven
Dimension: 170 x 240 – 200 x 300 cm
Special dimension available on request
Composed: 90% New Zeland Wool + 10% Cotton
Weight: 3,2 Kg mq
Time production: Ready to delivery
Color: Brown



Red



Rust



Lino Circle
BCXSY

Photo page: 062
Technique: Hand Tufted and Handwoven
Dimension: 170 x 240 + 85 x 280 – 200 x 300 + 100 x 340 cm
Special dimension available on request
Composed: 40% Wool + 30% Jute + 20% Linen + 10% Cotton
Weight: 5 Kg mq
Time production: Ready to delivery



Oasis 1.2
Karpeta Team

Photo page: 072
Technique: Handwoven
Dimension: 170 x 240 – 200 x 300 cm
Special dimension available on request
Composed: 90% Tencel + 10% Cotton
Weight: 5,5 Kg mq
Time production: Ready to delivery

**Oasis 2***Karpeta Team*

Photo page: 076

Technique: Handwoven

Dimension: 170 x 240 – 200 x 300 cm

Special dimension available on request

Composed: 90% Tencel + 10% Cotton

Weight: 5,5 Kg m²

Time production: Ready to delivery

**Rubber Tube***Karpeta Team*

Technique: Handwoven

Dimension: 60 x 200 – 170 x 240 – 200 x 300 cm

Special dimension available on request

Composed: 70% Polyester 30% Rubber

Weight: 3,5 Kg m²

Time production: Ready to delivery

**Moq***Karpeta Team*

Photo page: 080

Technique: Handwoven

Dimension: 170 x 240 – 200 x 300 cm

Special dimension available on request

Composed: 90% Tencel + 10% Cotton

Weight: 4,3 Kg m²

Time production: Ready to delivery

Color: Turtledove



Rust



Blue

**Savanna B***Karpeta Team*

Photo page: 090

Technique: Handwoven

Dimension: 170 x 240 – 200 x 300 cm

Special dimension available on request

Composed: 90% Tencel + 10% Cotton

Weight: 3,5 Kg m²

Time production: Ready to delivery

Pantone: Tomato



White

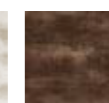

Turtledove



Beige

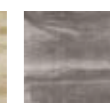

Silver

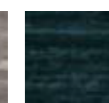

Prussian Blue



London Smoke

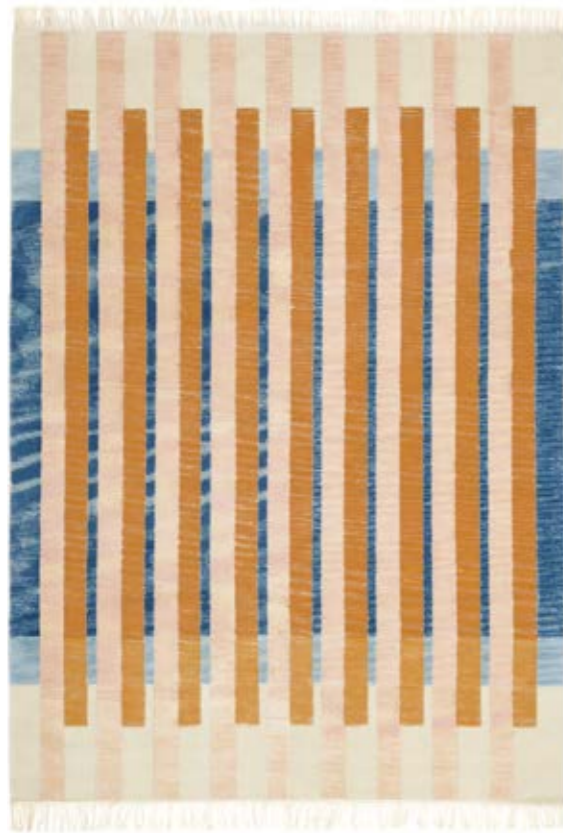

Magneto

Elsa Boch & Ferréol Babin

Photo page: 096

Technique: Handwoven

Dimension: 170 x 240 – 200 x 300 cm

Special dimension available on request

Composed: 90% Wool + 10% Cotton

Weight: 3 Kg mq

Time production: Ready to delivery

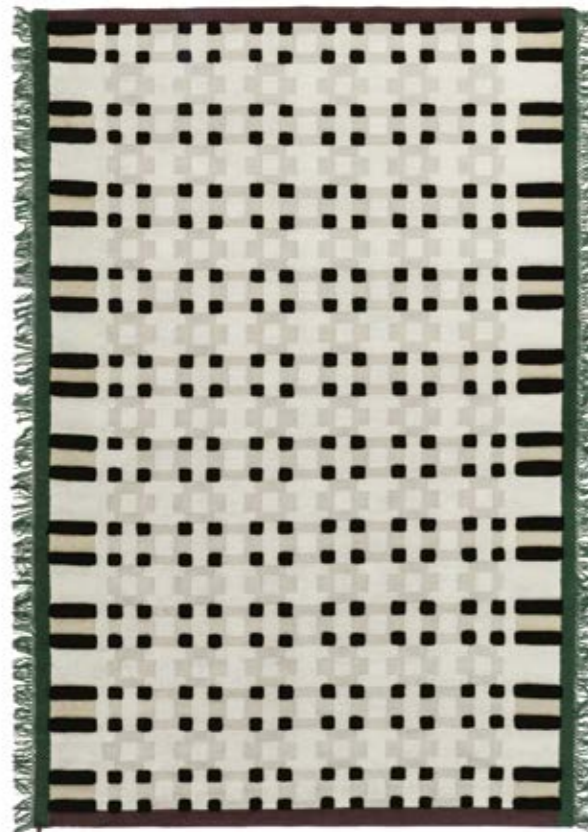

Mosaico

Giulia Ferraris

Photo page: 100

Technique: Handwoven

Dimension: 170 x 240 – 200 x 300 cm

Special dimension available on request

Composed: 90% Wool + 10% Cotton

Weight: 1,8 Kg mq

Time production: Ready to delivery



Acapo

Giulia Ferraris

Photo page: 106

Technique: Handwoven

Dimension: 170 x 240 – 200 x 300 cm

Special dimension available on request

Composed: 65% Wool + 25% Linen + 10% Cotton

Weight: 2,5 Kg mq

Time production: Ready to delivery



Blanco

Studio Testo

Photo page: 110

Technique: Handwoven

Dimension: 170 x 240 – 200 x 300 cm

Special dimension available on request

Composed: 90% Wool + 10% Cotton

Weight: 1,8 Kg mq

Time production: Ready to delivery

**Rubia**

Stefania Crippa
Studio Contromano

Photo page: 116

Technique: Handwoven and Overtuft

Dimension: 170 x 240 – 200 x 300 cm

Special dimension available on request

Composed: 90% New Zeland Wool + 10% Linen + 10% Cotton

Weight: 1,5 Kg mq

Time production: Ready to delivery

**Pompon**

Lio de Bruin

Photo page: 120

Technique: Handwoven

Dimension: 170 x 240 – 200 x 300 cm

Special dimension available on request

Composed: 90% Wool + 10% Linen + 10% Cotton

Weight: 2 Kg mq

Time production: Ready to delivery

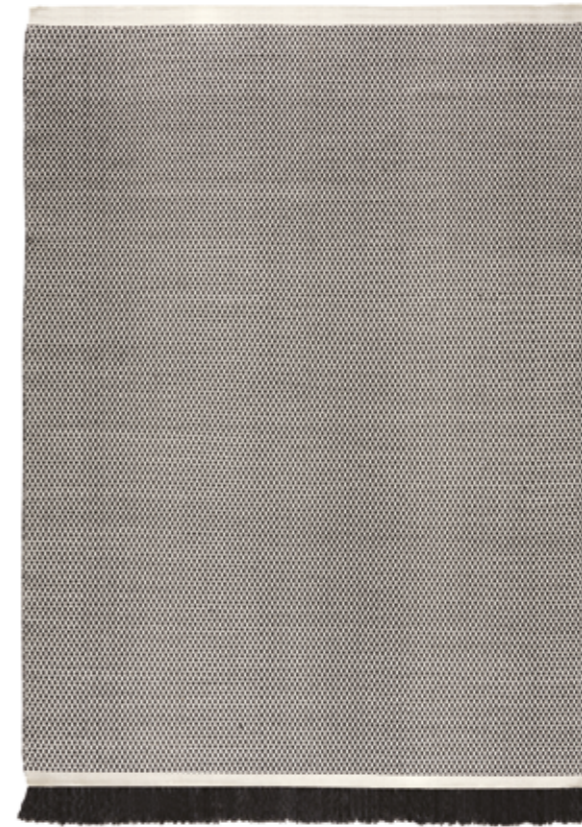
**Haiti**

Karpeta Team

Photo page: 126

Technique: Handwoven

Dimension: 170 x 240 – 200 x 300 cm

Special dimension available on request

Composed: 70% Wool + 30% Viscose

Weight: 1,8 Kg mq

Time production: Ready to delivery

Color: Black and White



Grey and Cyan



Rust and White

**Kleos**

Elisa Polimeni

Photo page: 130

Technique: Handwoven

Dimension: 170 x 240 – 200 x 300 cm

Special dimension available on request

Composed: 70% Felt + 20% Polyester + 10% Yute

Weight: 3,8 Kg mq

Time production: Ready to delivery

Color: Anthracite and Rust



Ocher and Brown



Deep Blue

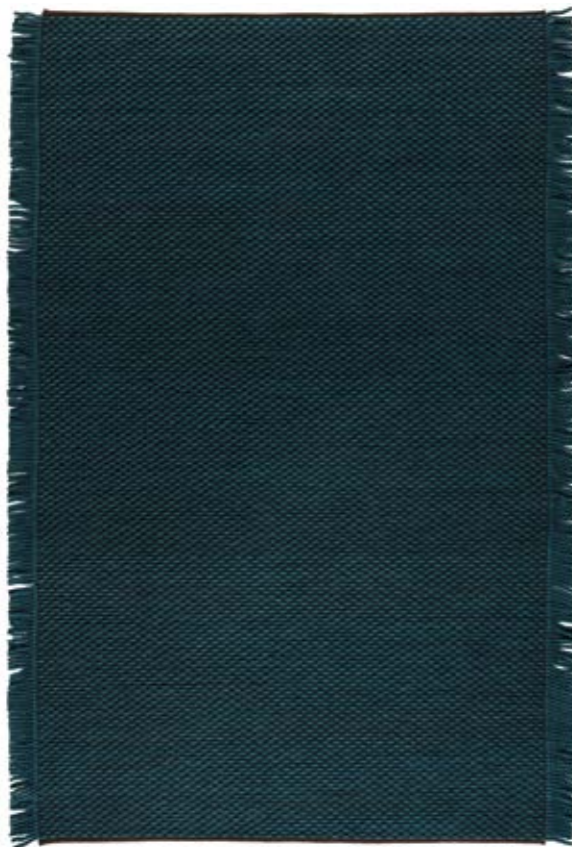

Kura
Karpeta Team

Photo page: 134
Technique: Handwoven
Dimension: 170 x 240 – 200 x 300 cm
Special dimension available on request
Composed: 50% Felt + 50% Polyester
Weight: 4 Kg mq
Time production: Ready to delivery

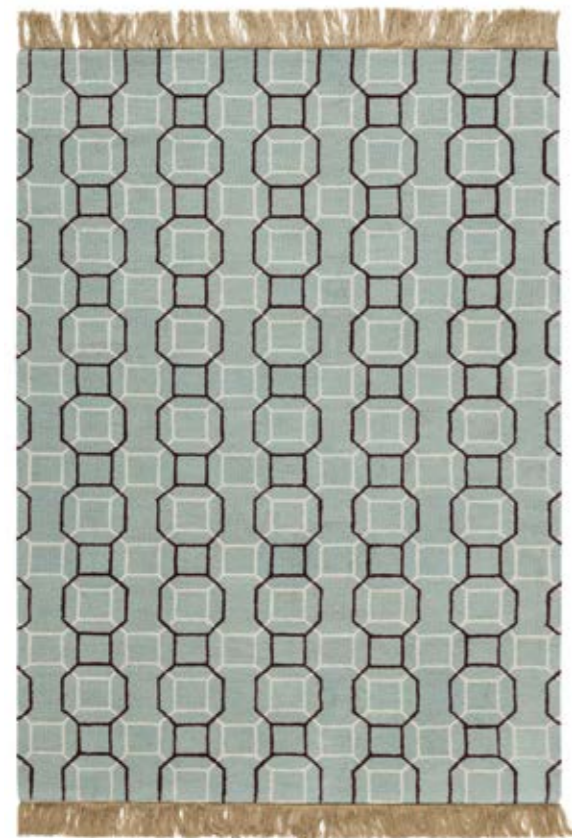

Meknès
Karpeta Team

Photo page: 138
Technique: Handwoven
Dimension: 170 x 240 – 200 x 300 cm
Special dimension available on request
Composed: 50% Wool + 40% Jute + 10% Cotton
Weight: 2 Kg mq
Time production: Ready to delivery

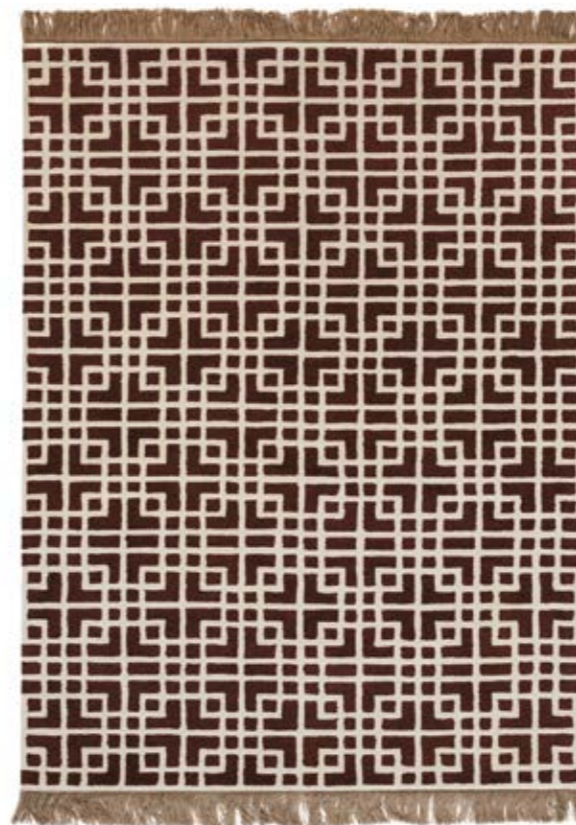

Zullayj
Karpeta Team

Photo page: 142
Technique: Handwoven
Dimension: 170 x 240 – 200 x 300 cm
Special dimension available on request
Composed: 50% Wool + 40% Jute + 10% Cotton
Weight: 2 Kg mq
Time production: Ready to delivery



Torrente
Studiocharlie & Silvia Destito

Photo page: 148
Technique: Handloom – Screen Printing
Dimension: 170 x 240 – 200 x 300 cm
Special dimension available on request
Composed: 90% Tencel + 10% Cotton
Weight: 4,2 Kg mq
Time production: Three months



Friendly
Karpeta Team

Photo page: 156
Technique: Handknotted
Dimension: 170 x 240 – 200 x 300 cm
Special dimension available on request
Composed: Wool + Jute on Cotton base
Knot Density: 93500 mq
Weight: 4 Kg mq
Time production: Three months



Sliding
Karpeta Team

Photo page: 162
Technique: Handknotted
Dimension: 170 x 240 – 200 x 300 cm
Special dimension available on request
Composed: Wool on Cotton base
Knot Density: 93500 mq
Weight: 4,8 Kg mq
Time production: Three months



Le ragazze
Valentina Cameranesi

Photo page: 168
Technique: Handknotted
Dimension: 170 x 240 – 200 x 300 cm
Special dimension available on request
Composed: Silk + Wool + Wool-Silk Blend on Cotton base
Knot Density: 153000 mq
Weight: 4,6 Kg mq
Time production: Three months



Psychedelic Flower
Valentina Cameranesi

Photo page: 172
Technique: Handknotted
Dimension: 170 x 240 – 200 x 300 cm
Special dimension available on request
Composed: Silk + Wool + Tencel + Linen on Cotton base
Knot Density: 153000 mq
Weight: 5 Kg mq
Time production: Three months



Antique Rose and Black

Rosemarie Auberson

Photo page: 176

Technique: Handknotted

Dimension: 170 x 240 – 200 x 300 cm

Special dimension available on request

Composed: Silk + Wool on Cotton base

Knot Density: 93500 mq

Weight: 3,7 Kg mq

Time production: Three months

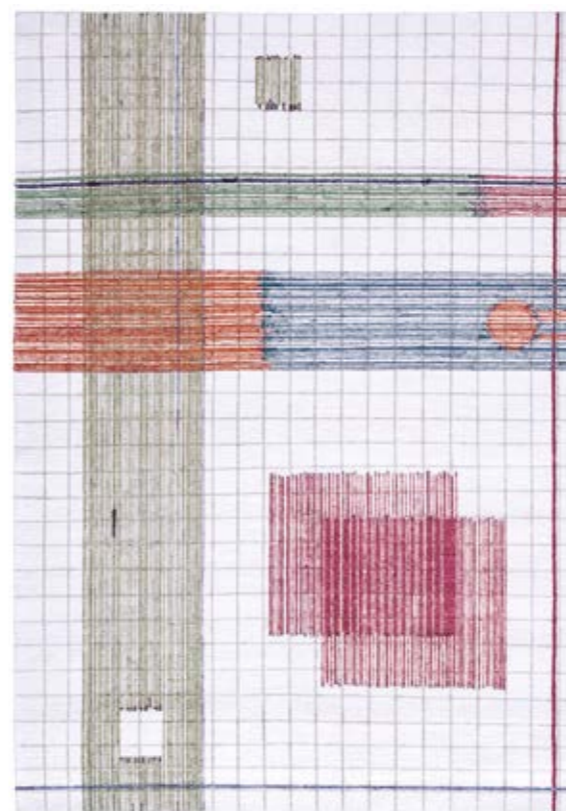

Tintas

José Mendoza

Photo page: 186

Technique: Handknotted and Soumak Weave

Dimension: 170 x 240 – 200 x 300 cm

Special dimension available on request

Composed: Wool + Jute on Cotton Warp

Knot Density: 93500 mq

Weight: 3,3 Kg mq

Time production: Three months



Esodo

Casalinghe Di Tokyo

Photo page: 182

Technique: Handknotted

Dimension: 170 x 240 – 200 x 300 cm

Special dimension available on request

Composed: Silk + Wool on Cotton base

Knot Density: 153000 mq

Weight: 4,3 Kg mq

Time production: Three months

Hand Knotted

Hand Knotted

IT — Una delle tecniche di tessitura più elaborate eseguite da artigiani specializzati, il nodo delle mani richiede una base iniziale, che viene fatta collegando il filo di ordito al telaio, tessendo il filo di trama per garantire la stabilità. Per creare la superficie del tappeto, gli artigiani incorporano individualmente ogni nodo, fila per fila. Il tipo e lo spessore del nodo offrono risultati diversi. Il numero di nodi per metro quadrato aumenta la qualità, la definizione e la durata del tappeto. Il metodo persiano è più tradizionale, con ogni nodo singolarmente tagliato a mano per creare il mucchio. La tecnica di Indo Nepal prevede un'asta che consente di tagliare un'intera fila di nodi. Il nodo a mano è un processo lento che consente la creazione di modelli altamente dettagliati.

EN — One of the most elaborate weaving techniques carried out by specialized artisans, the hand-knot requires an initial base, which is made by attaching the warp yarn to the loom, weaving the weft yarn to ensure stability. To create the surface of the rug, the artisans individually incorporate each knot, row by row. The type and thickness of the knot offers different results; the number of knots per square metre increases the quality, definition and durability of the rug. The Persian method is more traditional, with each knot individually cut by hand to create the pile. The Indo Nepal technique involves a rod that allows for an entire row of knots to be cut. Hand knotting is a slow process that allows for the creation of highly detailed patterns.

Screen Printing

Screen Printing

IT — Screen Printing è una tecnica in cui la stampa avviene su tappeti con vello o stuoie. Può essere fatto su qualsiasi materiale come lana, viscosa, juta, seta di bambù, lino, cotone o qualsiasi altro materiale. È possibile utilizzare fino a 4 colori per la stampa dello schermo, incluso il colore di base. In primo luogo il tappeto a tinta unita è realizzato in colore base e poi viene realizzata una cornice per ogni colore. Per esempio su una dimensione di 200 x 300 cm a 4 colori compreso il colore di base che è bianco. Il tappeto di base color bianco è tessuto a mano, a seguire vengono realizzate tre cornici, di dimensione 200 x 300 una per ogni colore scelto e per ogni disegno. Quindi, in totale tre fotogrammi saranno realizzati con tre diversi colori e disegni. Dopo che il primo colore viene applicato viene lasciato asciugare e si procede con l'applicazione del terzo e del quarto.

EN — Screen Printing is a technique in rug industry in which printing is done on pile and flat rugs. It can be done on any material like wool, viscose, jute, bamboo silk, linen, cotton or any other material. Maximum of 4 colours can be used in screen printing including base colour. First the handloom plain rug is made in base colour and then screen for each colour is made for that particular size. For example if there is a size of 200 x 300 cm and 4 colour are used in it including base colour which is white. Then the white colour rug will be made on handloom and then frame of each colour will be made of size 200 x 300 as per that colour's design. So in total three frames will be made of three different colour and different designs. After that 1st colour is applied and left to dry for few hours and then second and then third.

Hand Loomed

Hand Loomed

IT — Una precisa tecnica di tessitura manuale, che comprende telai verticali o orizzontali, eseguita da artigiani altamente qualificati. Il concetto di base della tessitura è quello di intersecare i fili longitudinali (lo spettro), con i fili trasversali (la trama). Il filo è allungato e fissato al telaio per creare un ordito teso. Lavorando dal basso verso l'alto, gli artigiani tessono la trama, creando i diversi modelli e texture. Per creare "il pile" la fibra è avvolta attorno ad una speciale asta durante il processo di tessitura e quindi tagliata per garantire la stessa altezza. Questa tecnica consente una vasta gamma di finiture, dal semplice e delicato pelo a corto raggio, dai tappeti a strisce a un più elaborato pile di loop che coinvolge varie fibre.

EN — A precise manual weaving technique, involving vertical or horizontal looms, carried out by highly skilled artisans. The basic concept of weaving is to intersect the longitudinal threads, (the warp), with the transverse threads, (the weft). The yarn is stretched and fastened to the loom to create a taut warp. Working from bottom to top, the artisans weave the weft, creating the different patterns and textures. To create the pile, the fibre is wrapped around a special rod during the weaving process and then cut to ensure equal height. This technique permits a wide range of finishes, from simple and delicate short-strand pile, shag rugs to more elaborate loop pile involving various fibres.

Hand Woven

Hand Woven

IT — La tecnica di tessitura a mano è famosa per la sua mancanza di "pile". Richiedendo conoscenze di esperti, artigiani capaci sono necessari per questo tradizionale metodo di tessitura che produce tappeti piani con modelli altamente dettagliati. Due esempi di tappeti in tessuto a mano sono il Soumak e il Kilim. Il Soumak è una tessitura piatta riconoscibile dalla sua trama intrecciata. Il Soumak può essere combinato con la tecnica annodata a mano e il Kilim su un unico telaio, creando un tappeto unico con tecniche diverse. Il Kilim è tessuto a mano con differenti trame colorate, presentando modelli dettagliati geometrici.

EN — The hand weaving technique is renowned for its lack of "pile". Requiring expert knowledge, skilled artisans are necessary for this traditional method of weaving that produces flat rugs with highly detailed patterns. Two examples of hand woven rugs are the Soumak and the Kilim. The Soumak is a flat weave recognisable by its braided texture. The Soumak can be combined with the hand knotted technique and the Kilim on a single loom, creating a unique rug with different techniques. The Kilim is hand woven with different coloured wefts, presenting detailed geometric patterns.



IT — Il lavoro minorile costituisce ancora oggi un grave problema in quelle parti del mondo in cui le condizioni di vita dei fanciulli lavoratori sono misere e le possibilità di istruzione minime. Poiché i magri guadagni dei fanciulli sono indispensabili per la sopravvivenza della famiglia, in certi casi, essi vengono ceduti dalla famiglia stessa a datori di lavoro che hanno anticipato una somma di denaro sulla quale sono dovuti onerosi interessi che i fanciulli devono rimborsare col proprio lavoro venendo così a trovarsi in una situazione di vera e propria schiavitù.

Da secoli i bambini vengono impiegati nella tessitura di tappeti ed oggi molte organizzazioni benefiche indiane e straniere si battono per la difesa dell'infanzia e contro lo sfruttamento del lavoro minorile. Karpeta partecipa alla iniziativa CARE & FAIR per la lotta contro il lavoro minorile in India, Pakistan e Nepal destinando una parte del valore delle sue importazioni al finanziamento di programmi di formazione e salute, costruzione di scuole ed ospedali. Tutti i tappeti Karpeta recano il logo Care & Fair, garanzia che la fabbricazione di tappeti avviene senza l'impiego di fanciulli lavoratori.

EN — Child labor is still a serious problem in those parts of the world where the working conditions of child workers are miserable and the possibility of education is limited. As the wages earned by child workers are an essential income for the family in some cases child workers are given directly to employers in exchange for loans which given their high interest rates require child workers to fall into a real state of slavery.

For centuries children have been employed in carpet weaving but today many organizations are fighting for child worker's rights. Karpeta participates in the Care & Fair movement for the fight against the use of child workers in India, Pakistan and Nepal giving a part of its import product value to initiatives for health and education, building schools and hospitals. All the Karpeta carpets made have the Care & Fair logo, a guarantee which assures that carpets are made without the use of child workers.



IT — Woolmark è sicuramente il marchio tessile più conosciuto. È la garanzia che attesta e certifica la realizzazione in Pura Lana Vergine, dove “pura” significa 100% lana, e “verGINE” indica che l'articolo è prodotto con fibre che non sono state precedentemente lavorate o recuperate da precedenti lavorazioni industriali.

La certificazione si ottiene sottoponendo il prodotto a prove effettuate presso i laboratori dell'istituto Woolmark Company. Oltre alla composizione, vengono anche verificate la resistenza al decoloramento a causa dell'esposizione alla luce, acqua, solventi per lavaggio, prove fisiche di resistenza, usura, piling, carico di rottura, etc. Inoltre, sui prodotti licenziati, possono essere effettuati in ogni momento controlli da parte degli organi competenti che si riservano il diritto di revocare la licenza d'uso del marchio nel caso in cui questi non soddisfino più i requisiti necessari.

EN — Woolmark is certainly the most well known textile brand. It is an international brand which assures the certifies that Pure Virgin Wool, where “pure” means 100% wool and “virgin” indicates that the fibers used have not been previously used or recovered from other manufacturing processes.

The certification is obtained by testing the product in a Woolmark Company laboratory so to check that all the required quality requirements have been reached. In addition to the composition, colorfastness in the presence of light, water, cleaning substances, wear, piling, and damage etc. Products carrying the license can be tested at anytime and Woolmark reserves the right to revoke the license if these requirements are no longer reached.

Tutti i nostri tappeti sono tessuti a mano

All our carpets are handmade

IT — Variazioni di misura sono possibili fino al 5% della misura totale e leggere variazioni di colore sono sempre possibili - in entrambi i casi non si tratta di un difetto del tappeto ma di fattori incontrollabili legati al metodo di lavorazione.

Evitare di poggiare mobili pesanti sul tappeto o mobili con angoli troppo accentuati, il peso potrebbe causare uno schiacciamento delle fibre che difficilmente potranno poi riacquistare la bellezza originaria.

EN — Sizing variation is possible up to 5% of the total measurement and slight variations in color are always possible - in both cases this should not be considered a defect but an uncontrollable factor tied to the production process.

Avoid placing heavy furniture on the carpet or furniture with pointed corners as, the weight could damage the fibers to the point where they will not easily return to their original form.

Manutenzione e pulizia

Care and cleaning

IT — La viscosa/tencel, filato morbido e brillante, rilascia fisiologicamente dei residui di filato a forma di piccole ciocche, fenomeno comunque connaturato alla sua natura. Non compromette in nessun modo la struttura, la qualità e la densità del vello. Non è da considerarsi un difetto del prodotto. È assolutamente sconsigliato:

- L'utilizzo di aspirapolvere ad alta potenza con spazzole girevoli;
- Tirare i fili che fuoriescono dalla superficie, si consiglia di tagliarli.

Si consiglia di trattare il tappeto nel rispetto assoluto delle indicazioni di manutenzione e pulizia evidenziate nel nostro catalogo o sito internet. Ne consegue che non saranno accettate richieste di reso o sostituzione supportate da argomentazioni legate alle caratteristiche e alle indicazioni sopra evidenziate.

EN — The soft and shiny viscose/tencel yarn, after its processing, requires a stabilization period during which can occur the loss of material in surplus. It is a phenomenon inherent to the nature of the yarn. It does not compromise in any way the structure, the quality or the density of the fleece. It must not be considered as a product defect.

It is absolutely not recommended:

- To use a high-powered vacuum cleaner or one with rotating brushes;
- To pull the wires protruding from the surface, it is advisable to cut them.

It is absolutely recommended to treat the carpet strictly following the instructions for maintenance and cleaning pointed out by the catalogue or on the website. Consequently, requests for return or replacement of the carpet supported by arguments already highlighted by the above listed will not be accepted.

Campionario - Espositore verticale

Set of samples - Vertical display

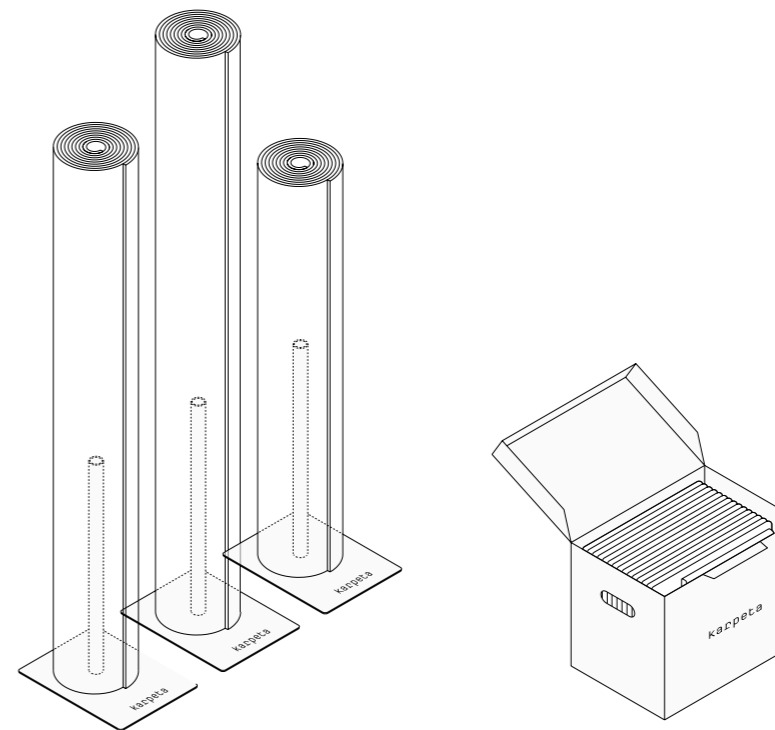

IT — Il box contiene catalogo, listino prezzi, 18 campioni di tappeto 20x20cm.

Karpeta introduce un'importante novità per esporre i propri prodotti: un'esposizione verticale che possa venire incontro alle esigenze dei propri rivenditori dando al contempo maggiore visibilità ai nostri prodotti.

Tale esposizione è garantita da una basetta in ferro, con al centro un perno che garantisce l'appoggio stabile al tappeto e, ben visibile, il logo Karpeta.

EN — The box contains the catalog, price list, 18 samples of carpet 20x20cm.

Karpeta introduces a very important innovation in order to show his own products: a vertical exposition that panders to the seller needs and gives high-visibility to our products.

This exposition is guaranteed by an iron base with an iron cylinder that assures a stable support to the carpet and shows the Karpeta logo.

Campionario - Espositore verticale*Set of samples - Vertical display*

IT — L'esposizione verticale dei nostri tappeti è un'operazione studiata per offrire numerosi vantaggi:

Spazio: esporre verticalmente i tappeti significa beneficiare di un importante risparmio in termini di spazio che possa agevolare i rivenditori nella propria attività.

Pulizia: la verticalizzazione e il conseguente ordine del prodotto garantiscono che il tappeto rimanga intatto contro l'usura e lo sporco. Ciò permette di eliminare gli eventuali costi da parte del negozio, tra cui quello manutentivo.

Impatto visivo: l'esposizione verticale dei tappeti migliora l'impatto visivo e la rilevanza che il cliente avrà nel poter visionare ogni singolo prodotto.

Sostituzione: l'esposizione verticale e il conseguente vantaggio della garanzia contro usura e sporczia, garantiscono, ulteriormente, la possibilità della sostituzione del tappeto*.

Gestione: l'esposizione verticale assicura una facile gestione all'interno del negozio per eventuali spostamenti in allestimento.

Ogni basetta richiesta sarà consegnata da Karpeta al rivenditore a titolo di Comodato d'uso.

Il cliente sarà vincolato alle responsabilità derivanti dal comodato, per cui si impegnerà a mantenere intatte le basette in ferro consegnate.

La richiesta delle basette espositive comporta per il rivenditore la riduzione dello sconto concesso pari al 5%.

Ogni base servirà esclusivamente ad esporre prodotti Karpeta.

Karpeta si riserva di ritirare le basette consegnate in comodato, in caso di mala gestione delle stesse.

* Da concordare preventivamente con l'azienda all'atto della campionatura

EN — The vertical exposition of our carpets gives several advantages:

Space: showing vertically carpets means to save space and to facilitate seller in his own enterprise.

Clean: this allows carpets to remain intact and clean, avoiding possible costs of maintenance.

Visual impact: the vertical exposition improves the visual impact and give to the public the opportunity of enjoying every single carpet.

Management: this kind of exposition makes possible to manage easily the products inside the shop.

Replacement: all these advantages guarantee the option of replacing the carpet*.

Each iron base will be delivered by Karpeta as loan for use; for this reason it is very important that the customer preserves the iron base.

The request of the iron base implies for the seller a reduction of 5% discount.

Each iron base will be used for showing Karpeta products.

Karpeta reserves the right to withdraw the iron base in case of poor management.

* Agreed in advance with Karpeta

Domande frequenti*FAQ**IT — Perché il tappeto Karpeta non è dotato di antiscivolo sotto il tappeto?*

L'antiscivolo complica la corretta ed agevole pulizia del pavimento e del tappeto stesso. Il peso dei nostri tappeti in via prevalente evita il ricorso all'antiscivolo.

Il tappeto può scolorire alla luce?

Certamente, le fibre naturali temono la luce diretta del sole, pertanto necessita attenzione.

Perché il tappeto in fibra naturale (poliestere escluso), rilascia materiale?

Perché nel primo periodo, dopo l'apertura del tappeto, le fibre si distendono e viene rilasciato il surplus di lavorazione. Con l'utilizzo ed una pulizia quotidiana gradualmente le fibre si assesteranno.

Perché c'è un filo che può sporgere dal tappeto?

Fermo restando che non è considerabile difetto, talvolta può accadere che un filo si allenti o si sfili senza compromettere la consistenza e la qualità intrinseca del prodotto. Si consiglia di tagliarlo.

E' possibile lavare i tappeti ad acqua?

No, in relazione al tipo di tappeto si rimanda a ns. precise indicazioni di pulizia, fatto salvo il ricorso a centri specializzati nel lavaggio dei tappeti.

E' impiegata la manodopera minorile?

La nostra certificazione CARE AND FAIR garantisce il contrasto allo sfruttamento del lavoro minorile.

EN — Why are Karpeta carpets not supplied with an anti-slip under the carpet?

The anti-slip complicates the cleaning of both the floor and the carpet itself. The weight of our carpets makes an anti-slip unnecessary.

Will the carpet lose colour in sunlight?

Certainly, natural fibres react badly to direct sunlight and therefore this should be avoided.

Why do natural fibre carpets (polyester excluded), shed material?

Because at the first stage, once the carpet is open, the fibres relax and the surplus fibres are expelled from the pile. This will gradually decrease through time and use.

Why are there stray fibres from the carpet?

This should not be considered a defect as occasionally a thread may become loose but this does not compromise the consistency or quality of the product. Cutting is recommended.

Is it possible to wash the carpet with water?

No, with regard to the care instructions for each type of carpet we recommend reading our cleaning indications and/or take advice directly from a specialist cleaning centre.

Is child labour used in the creation of our carpets?

Our certificate CARE AND FAIR guarantees our opposition to the use of child labour.

Contract*Contract*

IT — Karpeta offre ad aziende, studi di architettura e interior designer che lavorano con il settore contract (ville, hotel, uffici, negozi, yacht...) di creare grazie al supporto del team Karpeta tappeti sartoriali su disegno che si adattino perfettamente alle esigenze del progetto.

EN — Karpeta offers companies, architectural and design firms in the contract sector (houses, offices, hotels, shops, yachts...) the opportunity to work alongside our team of experts to design and create the perfect rugs for your project.

Fatto su misura*Taylor Made*

IT — Tutta l'esperienza, la professionalità e la maestria Karpeta sono a disposizione del cliente per assisterlo nell'acquisto o nella progettazione di tappeti realizzati con ogni tipo di filato e colore, dimensione e disegno.

EN — You will have at your disposal our experience, ability and expertise in assisting you with the purchase or development of rugs of all colours, yarn, size and design.



Karpeta SRL
Via Provinciale Spirito Santo Cannavò, 2
89128 - Reggio Calabria
Italia

www.karpeta.it
info@karpeta.it
T: +39 0965645480
F: +39 0965643176
P.IVA 02941170801

Art Direction: *Chiara Andreatti*
Design: *Bianca Previato Schiesari*

Photo "Cave": *Adrianna Glaviano*
Concept and Location: *Anticàmera Location Agency*

Photo Urban: *Francesca Ferrari*
Still Life: *Sara Magni*

Thanks to: *Yota Viktoratou*

Text: *Alessia Candito*
Translation: *Natalino Parrilla*
Print: *Grafiche Antiga — Settembre 2017*

Karpeta all rights reserved