

VL STUDIO TABLE/FLOOR LAMP

VL Studio Table/Floor Lamp - 5744169354

The fixture emits a glare-free diffused light. The triple-layered opal glass provides a very comfortable light distribution and radiates a pleasantly delicate glow to the surroundings.

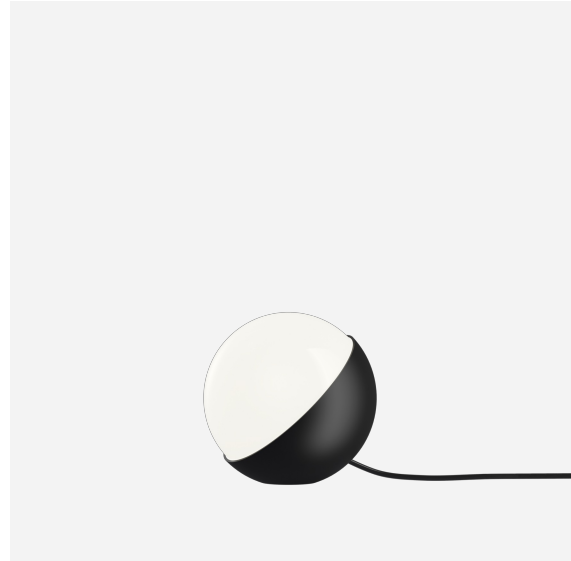

Vilhelm Lauritzen

Vilhelm Lauritzen (1894–1984) is one of the most significant architects in the history of Denmark; he was the trail-blazing figurehead of Danish functionalism. A number of his buildings – Nørrebro Theatre (1931–32), Daeils Varehus department store (1928–35), Radihuset (1936–41) and the first airport built in Kastrup (1937–39) – represented the concentrated essence of contemporary life.



Product info

Information

The untreated brass will change over time and develop a patina.

Mounting

Glass can be unscrewed to change the light source. 2.5 m. Cord. Black for black version and white on brass versions. Ø150: On/off switch on cable. Ø250 and Ø320: Electronic dimmer on cable for regulation of light brightness (requires suitable light source).

Finish

Matt black, wet painted or brushed brass with fine hairlines. White opal glass, glossy. Unlacquered brass which will develop a patina.

Materials

Glass: Mouth-blown, 3-layered opal glass, glossy. Housing: Deep drawn aluminum or brass. Please note the untreated brass will patinate.

Sizes and weights

width x Height x Length (mm) | 250 x 244 x 250 Max 3.8 kg | 320 x 310 x 320 Max 7.9 kg | 150 x 145 x 150 Max 1.3 kg

Class

Ingress protection IP20. Electric shock protection II.

Light source

1x25W G9

Information

The untreated brass will change over time and develop a patina.

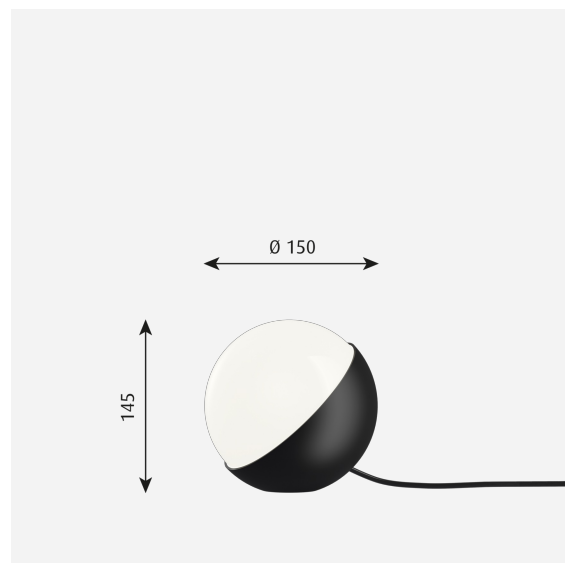

Related products

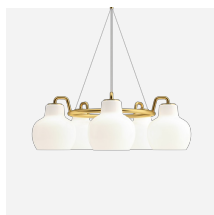

VL Ring Crown 3-5-7 Pendant



VL Ring Crown 1 Pendant

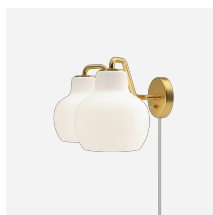

VL Ring Crown 2 Wall Lamp



VL 45 Radiohus Pendant

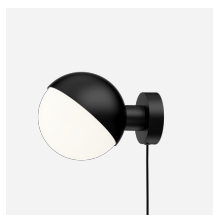

VL Studio Wall Lamp

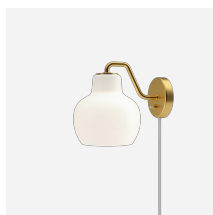

VL Ring Crown 1 Wall Lamp

Light distribution diagrams

Cartesian

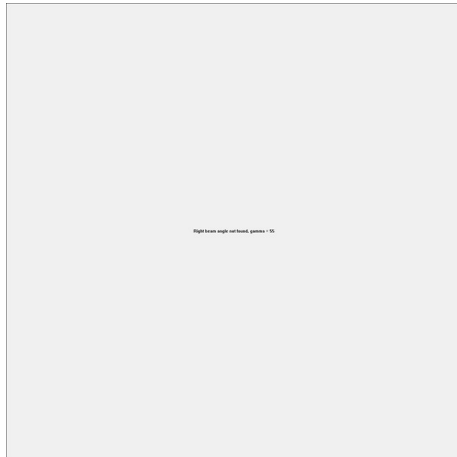

Isolux

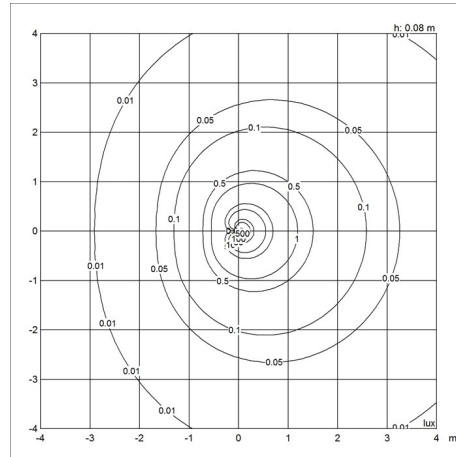

Polar

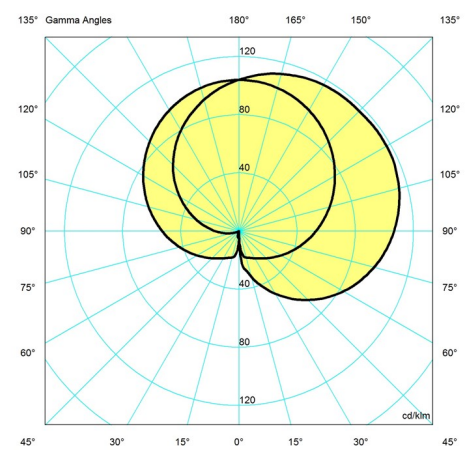

Spare parts & accessories

Product	Variant number
VL Studio Ø320 Table glass	5744167864
VL Studio Table/Wall, White grommet	5744167877
VL Studio Ø150 Wall glass	5743151868
VL Studio Ø250 Table glass	5744167851
VL Studio Table/Wall, Black grommet	5744167880

Data specifications

Colour	Black (RAL RAL 9011 G: 30)	Length	150
Width	150	Height	145
Built-in Height	-	IP class	20
Class	II	Net Weight	1.1
Standby (W)	-	Power Factor (P = 100 % / P = 50 %)	-
Inrush Current	-	Light source	1x25W G9

VL Studio Table/Floor Lamp

Kelvin	-
SDCM	-
Watt	1.9
Light control	-
UGR Transversal / Axial	< 0/11.6
Driver life	-

CRI	-
Lumen	150
Efficacy	79
Min. Dim Level (%)	-
L80B50 (hours)	-